

• Fiat Doblò 2010->

Compatible with these double DIN devices

Pioneer Navigation

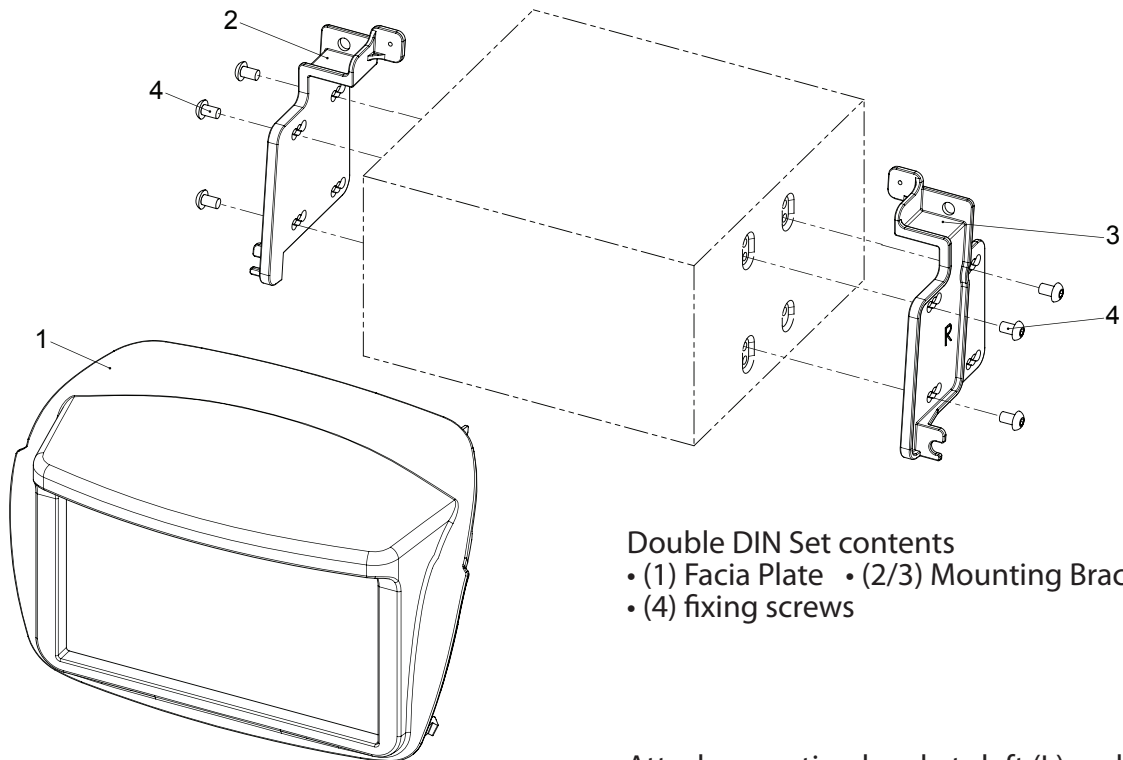

Double DIN Set contents

- (1) Facia Plate
- (2/3) Mounting Brackets
- (4) fixing screws

Attach mounting brackets left (L) and right (R) to Pioneer Navigation (use the first of three possible holes as shown on the photo below)

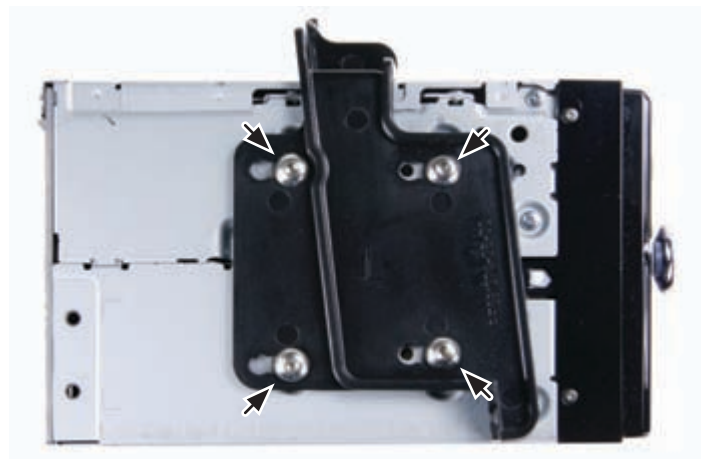
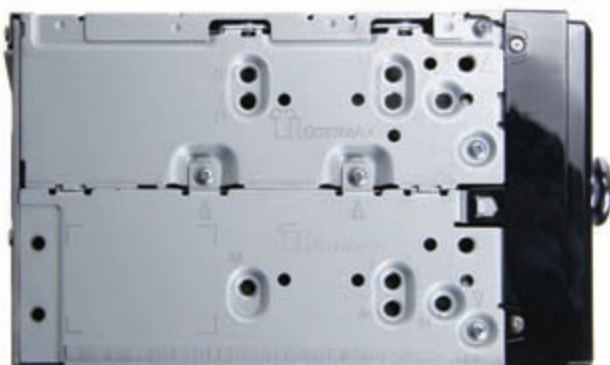

Installation Manual Double DIN Kit: Fiat Doblò 2010->

Please study the installation manual carefully, before you start. The installation requires some cutting works of the OEM-Panel. All OEM screws have to be reused again



1. Remove OEM Radio with special radio release keys



2. Remove 2 screws (left and right)

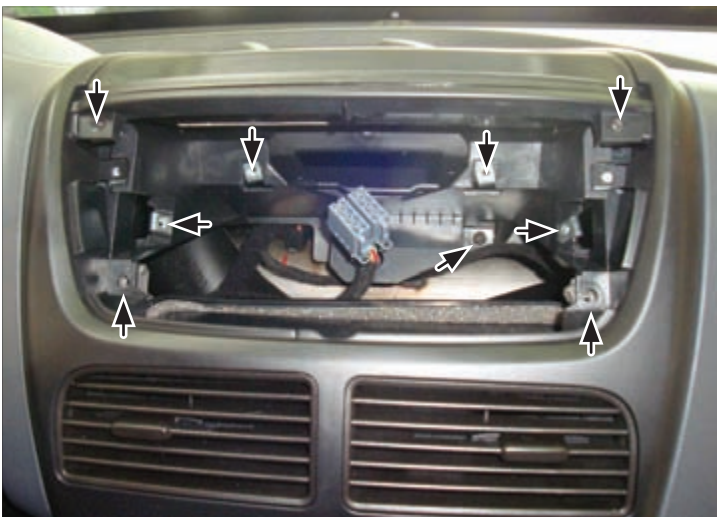

3. Remove screws holding center panel (see arrows)

Info: You have to reuse the screws later

Unclip center panel

Remove center panel

4. Disassemble center panel (you have to reuse the screws later!)



5. Cut upper part from center panel inlay (the upper part - see cross - won't be needed anymore)

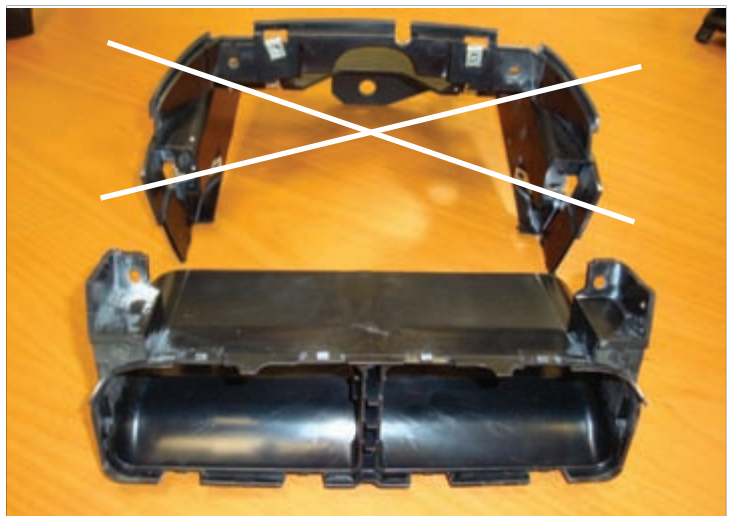
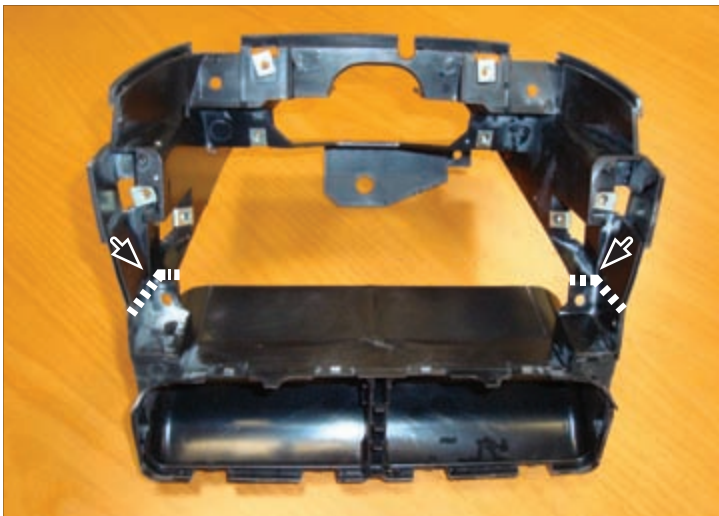

6. Cut this part at center console (see dashed line)

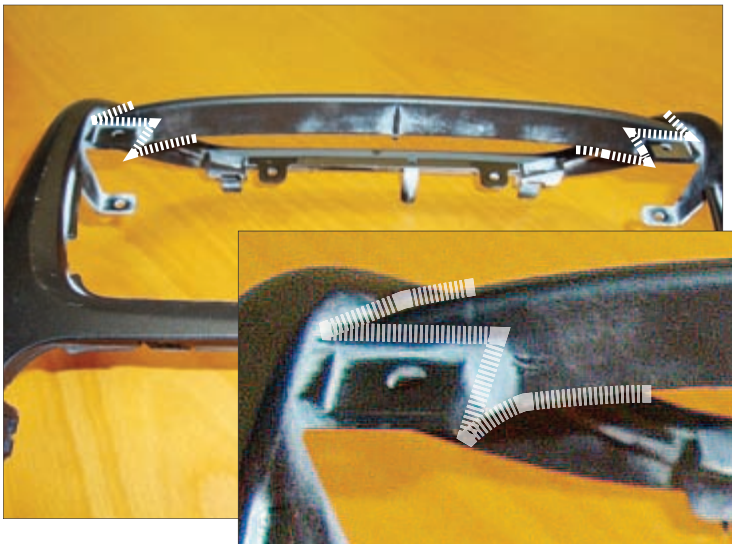

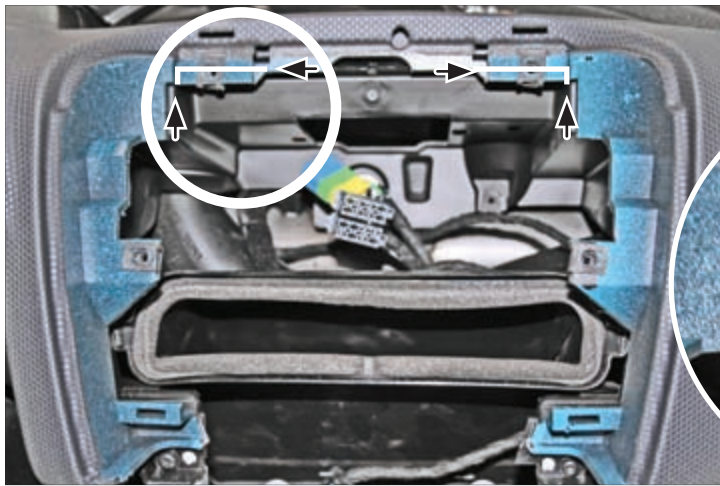

7. Cut plastic here (see arrows)

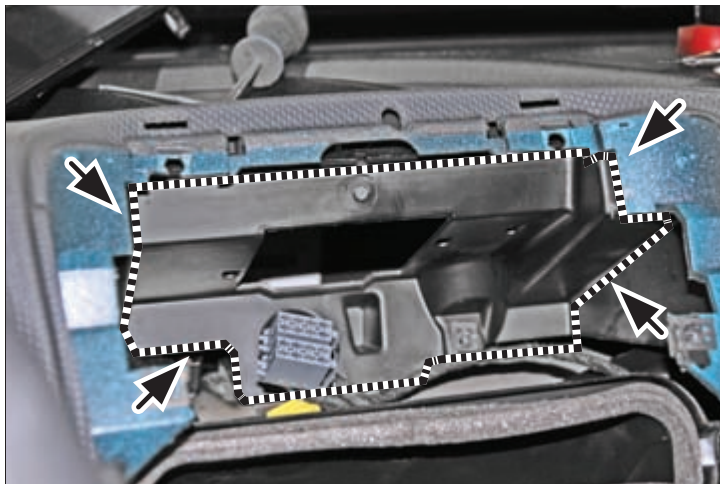
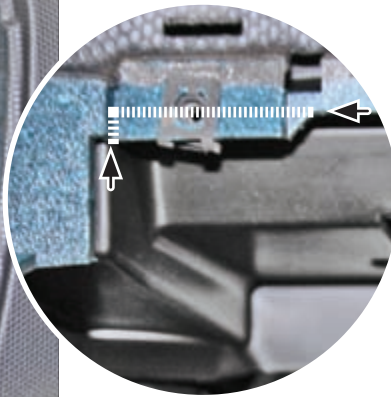

8. Cut plastic in order to clear space for double DIN head unit (see dashed line)

Assemble center panel
Mount Navigation to center panel

Important: On top, the mounting bracket has to be **BEHIND** the OEM frame with the screw-hole. On bottom the mounting bracket has to be in **FRONT** of the OEM frame. (see sample photos)

Connect all required circuit points. Mount complete center panel. Place fascia plate

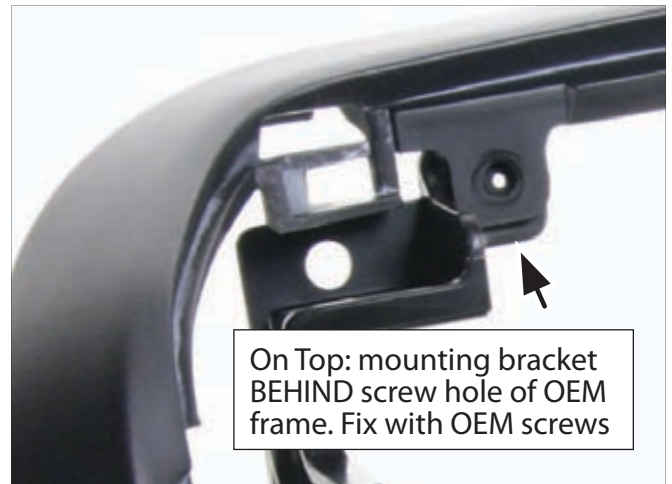

On Top: mounting bracket **BEHIND** screw hole of OEM frame. Fix with OEM screws



On bottom: mounting bracket in **FRONT** of screw hole of OEM frame. Fix with OEM screws