



5 0 5 5 1 9 3 1 3 3 2 3 4 1

Installation Manual Ford Focus 2011>

Kit Includes:

- A. 1x 2 DIN Facia Kit
- B. 1 x Steering Wheel Interface

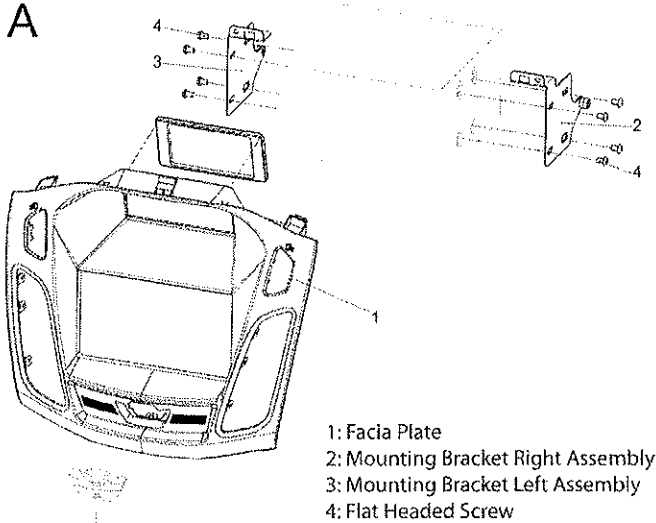

Spare OEM hazard light switch by Ford required

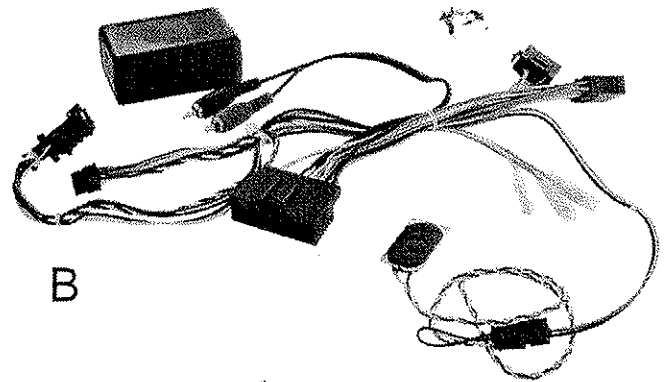

1. Ford Focus OEM Dashboard (sample photo)

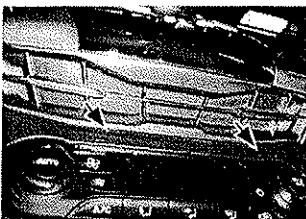

2. Unclip panel under OEM radio

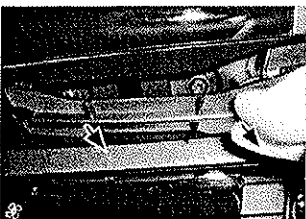

3. Remove Panel under OEM radio

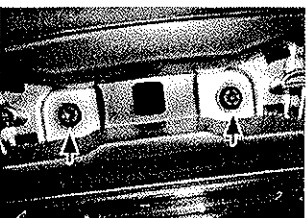

4. These 2 screws need to be removed

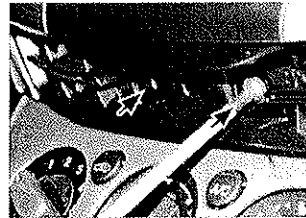

4a. Remove 2 screws under OEM radio



5. Unclip OEM panel

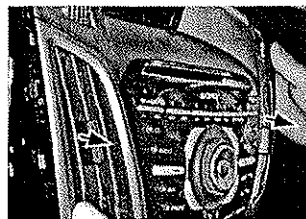

6. Remove OEM panel carefully

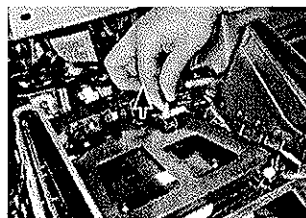

7. Unplug cables

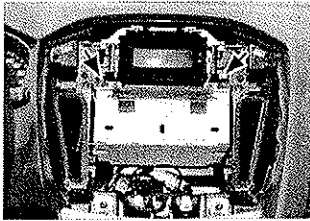

8. Remove 2 screws (see arrows)
Remove OEM head unit

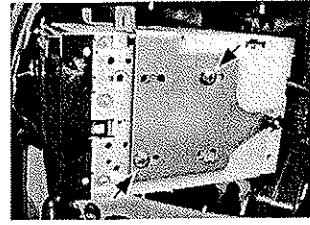

10. Mount mounting brackets to
double DIN head unit

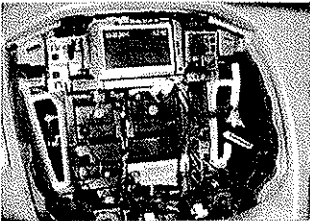

9. OEM dash board with removed
head unit

11. Connect interface to vehicle

A.

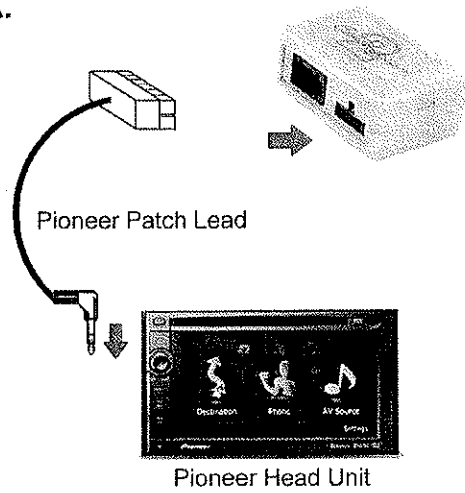

B.

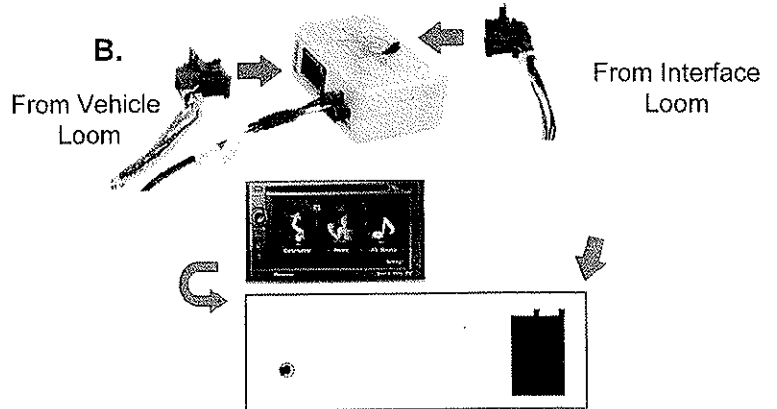

C.

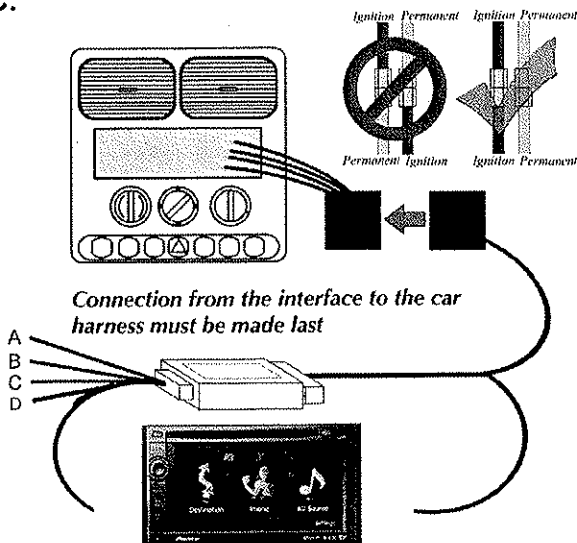

D.

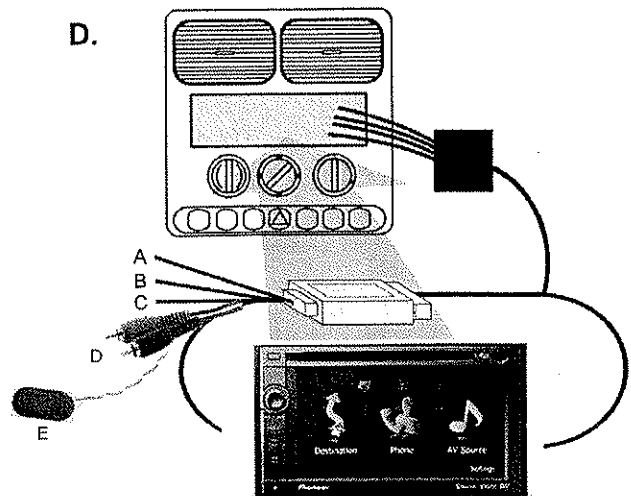

- | | |
|-----------------------|--|
| A - Pink Wire | = Speed Pulse |
| B - Green Wire | = Park Brake |
| C - Purple/White Wire | = Reverse |
| D - RCA Leads | = Connect to aftermarket head unit aux in to retain factory aux plug |
| E - Speaker | = Connect to slot on rear of facia plate |

If vehicle display remains blank, push and hold the source button on the steering wheel

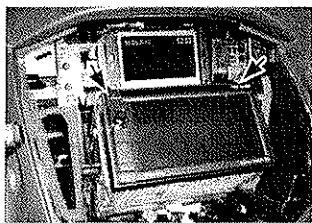
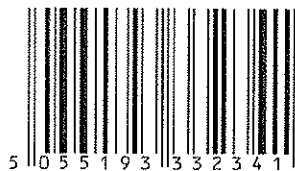

12. Install double DIN head unit

Connect all required circuit points and connections. Please see stalk interface manual for connecting stalk interface

Fix navigation with OEM screws

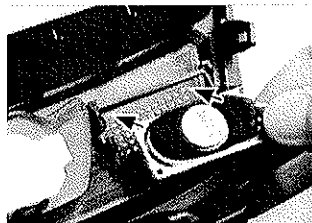

15. as needed fix speaker with cyanoacrylate adhesive

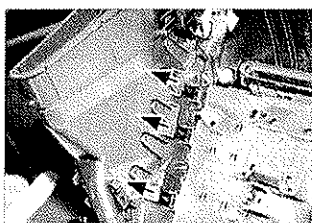

Preparation of fascia plate

13. Unclip 2 OEM air vents

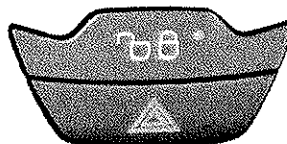

16. A spare OEM hazard light switch by Ford is required.

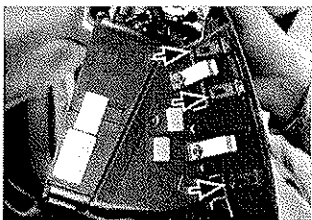

Preparation of fascia plate

14. Mount them to new fascia plate

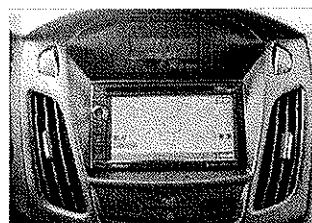

17. Mount spare hazard light switch to fascia plate. Clip fascia plate on dashboard. Install everything in reverse order.

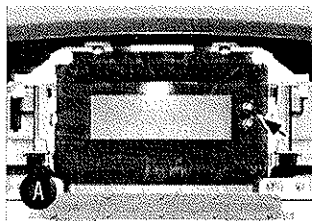

The Focus is equipped with two kinds of OEM displays

A: Display with 2 buttons at right side (see arrow)

No trim frame required

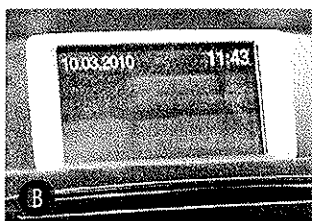

B: Colour Display:

Clip trim frame to fascia plate

