

Pioneer

Operation Manual

RDS MEDIA CENTER RECEIVER

MVH-8300BT MVH-7300



Made for



iPod



iPhone

English

Thank you for purchasing this PIONEER product.

To ensure proper use, please read through this manual before using this product. It is especially important that you read and observe **WARNING**s and **CAUTION**s in this manual. *Please keep the manual in a safe and accessible place for future reference.*

01 Precautions

- IMPORTANT SAFEGUARDS 4
- To ensure safe driving 4
- To avoid battery exhaustion 5

02 Before you start

- About this unit 6
- Operating environment 6
- In case of trouble 6
- Resetting the microprocessor 6
- Demo mode 7
- About this manual 7

03 Operating this unit

- Head unit 8
- Optional remote control 8
- Basic operations 9
- Basic menu operations 9
 - Menu operations identical for function settings/audio adjustments/initial settings/lists 10
- Customizing menus 10
 - Canceling a Registered Menu 11
- About guide information 11
- Using Bluetooth telephone 11
 - Setting up for hands-free phoning 11
 - Basic operations 11
- Radio 12
 - Basic operations 12
 - Using PI Seek 13
 - Using Auto PI Seek for preset stations 13
 - Storing and recalling stations for each band 13
 - Function settings 13
 - Storing and recalling radio text 14
 - PTY list 14
- Playing moving images 15
 - Basic operations 15

- Selecting and playing files from the name list 16
- Browsing for a video on the iPod 16
- Playing DivX® VOD content 16
- Function settings 17

Playing audio 19

- Basic operations 19
- Selecting and playing files/tracks from the name list 20
- Browsing for a song on the iPod 20
- Function settings 20

Playing still images 22

- Basic operations 22
- Selecting and playing files from the name list 23
- Function settings 23
- Introduction of operations for playback of still images as a slideshow 24

Bluetooth Telephone 25

- Connection menu operation 25
- Phone menu operation 26
- Function and operation 27

Audio Adjustments 28

System settings 29

Entertainment settings 30

- Customizing the illumination color 31

Initial Settings 31

- Auto EQ (auto-equalizing) 32

Other functions 34

- Using an AUX source 34
- Switching the display indication 35

04 Detailed instructions

Changing the wide screen mode 36

Setting the DivX subtitle file 36

Setting the aspect ratio 36

Displaying the DivX® VOD registration code 36

Displaying the deregistration code 37

Changing the picture adjustment 37

● Additional information

- Troubleshooting **38**
- Error messages **38**
- Understanding auto EQ error messages **40**
- Indicator list **41**
- Handling guidelines **42**
- Compressed audio/video compatibility (USB, SD) **43**
- iPod compatibility **44**
- Sequence of audio files **45**
- Using the display correctly **45**
 - Handling the display **45**
 - Liquid crystal display (LCD) screen **45**
 - LED (light-emitting diode) backlight **46**
 - Fluorescent tube **46**
- Copyright and trademark **46**
- Specifications **47**

IMPORTANT SAFEGUARDS

Please read all of these instructions regarding your display and retain them for future reference.

- 1 **Read this manual fully and carefully before operating your display.**
- 2 **Keep this manual handy as a reference for operating procedures and safety information.**
- 3 **Pay close attention to all warnings in this manual and follow the instructions carefully.**
- 4 **Do not allow other persons to use this system until they have read and understood the operating instructions.**
- 5 **Do not install the display where it may (i) obstruct the driver's vision, (ii) impair the performance of any of the vehicle's operating systems or safety features, including air bags, hazard lamp buttons or (iii) impair the driver's ability to safely operate the vehicle.**
- 6 **Do not operate this display if doing so in any way will divert your attention from the safe operation of your vehicle. Always observe safe driving rules and follow all existing traffic regulations. If you experience difficulty in operating the system or reading the display, park your vehicle in a safe location and make necessary adjustments.**
- 7 **Please remember to wear your seat belt at all times while operating your vehicle. If you are ever in an accident, your injuries can be considerably more severe if your seat belt is not properly buckled.**
- 8 **Never use headphones while driving.**
- 9 **To promote safety, certain functions are disabled unless the parking brake is on, and the vehicle is not in motion.**
- 10 **Never set the volume of your display so high that you cannot hear outside traffic and emergency vehicles.**



WARNING

Do not attempt to install or service your display by yourself. Installation or servicing of the display by persons without training and experience in electronic equipment and automotive accessories may be dangerous and could expose you to the risk of electric shock or other hazards. 

To ensure safe driving



WARNING

- **LIGHT GREEN LEAD AT POWER CONNECTOR IS DESIGNED TO DETECT PARKED STATUS AND MUST BE CONNECTED TO THE POWER SUPPLY SIDE OF THE PARKING BRAKE SWITCH. IMPROPER CONNECTION OR USE OF THIS LEAD MAY VIOLATE APPLICABLE LAW AND MAY RESULT IN SERIOUS INJURY OR DAMAGE.**
- To avoid the risk of damage and injury and the potential violation of applicable laws, this unit is not for use with video that is visible to the driver.
- To avoid the risk of accident and the potential violation of applicable laws, no viewing of front seat video should ever occur while the vehicle is being driven.
- In some countries or states the viewing of images on a display inside a vehicle even by persons other than the driver may be illegal. Where such regulations apply, they must be obeyed.

When you attempt to watch a video image while driving, the warning **Viewing of front seat video source while driving is strictly prohibited.** will appear on the front display. To watch a video image on the front display, park your vehicle in a safe place and apply the parking brake. 

Precautions

To avoid battery exhaustion

Keep the vehicle engine running when using this unit to avoid draining the battery power.

- When no power is supplied to this unit, such as when the vehicle battery is being replaced, the microcomputer of this unit returns to its initial condition. We recommend that you transcribe the audio adjustment data.



WARNING

Do not use with vehicles that do not feature an ACC position.

Before you start



If you want to dispose this product, do not mix it with general household waste. There is a separate collection system for used electronic products in accordance with legislation that requires proper treatment, recovery and recycling.

Private households in the member states of the EU, in Switzerland and Norway may return their used electronic products free of charge to designated collection facilities or to a retailer (if you purchase a similar new one).

For countries not mentioned above, please contact your local authorities for the correct method of disposal.

By doing so you will ensure that your disposed product undergoes the necessary treatment, recovery and recycling and thus prevent potential negative effects on the environment and human health. 

About this unit

The tuner frequencies on this unit are allocated for use in Western Europe, Asia, the Middle East, Africa and Oceania. Use in other areas may result in poor reception. The RDS (radio data system) function only operates in areas with broadcasting RDS signals for FM stations.

CAUTION

- Do not allow this unit to come into contact with liquids. Electrical shock could result. Also, damage to this unit, smoke, and overheating could result from contact with liquids.
- The Pioneer CarStereo-Pass is for use only in Germany.
- Always keep the volume low enough to hear outside sounds.
- Avoid exposure to moisture.

- If the battery is disconnected or discharged, any preset memory will be erased.

Note

Function setting operations are completed even if the menu is cancelled before the operations are confirmed. 

Operating environment

This unit should be used within the temperature ranges shown below.

Operating temperature range: -10°C to $+60^{\circ}\text{C}$
 EN300328 ETC test temperature: -20°C and $+55^{\circ}\text{C}$ 

In case of trouble

Should this product fail to operate properly, please contact your dealer or nearest authorized Pioneer Service Station. 

Resetting the microprocessor

The microprocessor must be reset in the following situations:

- Before using this unit for the first time after installation
- If the unit fails to operate properly
- When strange or incorrect messages appear on the display

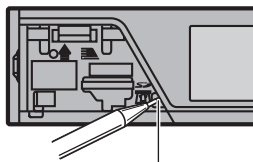

RESET button

- 1 Remove the front panel.
- 2 Press RESET with a pen tip or other pointed instrument. 

Before you start

Demo mode

Important

Failure to connect the red lead (ACC) of this unit to a terminal coupled with ignition switch on/off operations may lead to battery drain.

The demo automatically starts when the ignition switch is set to ACC or ON while the unit is turned off. Turning off the unit does not cancel demo mode. To cancel the demo mode, operate the function in the initial setting menu. Operating the demo while the ignition switch is set to ACC may drain battery power.

Refer to **Demonstration** (*demo display setting*) on page 32. 

About this manual

- This manual describes operations of both MVH-8300BT and MVH-7300. Only MVH-8300BT features Bluetooth functions, so the explanations for those functions do not apply to MVH-7300.
- In the following instructions, USB memories, USB portable audio players, and SD memory cards are collectively referred to as “external storage devices (USB, SD)”. If only USB memories and USB portable audio players are indicated, they are collectively referred to as “USB storage devices”.
- In this manual, iPod and iPhone will be referred to as “iPod”. 

Head unit

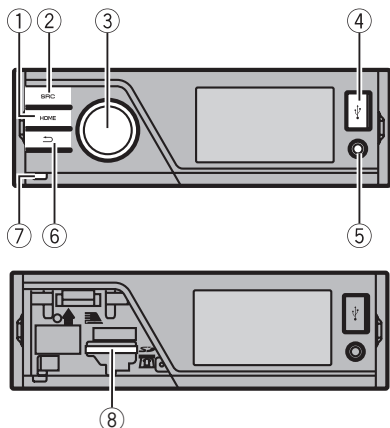

Part	Part
① HOME	⑤ AUX input jack (3.5 mm stereo/video jack)
② SRC/OFF	⑥ Microphone input jack for auto EQ measurement
③ MULTI-CONTROL (M.C.)	⑦ ↵ (back/display off)
④ USB port	⑧ Detach button
	⑧ SD memory card slot
	⑧ Remove the front panel to access the SD memory card slot.

⚠ CAUTION

Use an optional Pioneer USB cable (CD-U50E) to connect the USB audio player/USB memory as any device connected directly to the unit will protrude out from the unit and may be dangerous. Do not use unauthorized products.

Optional remote control

The remote control CD-R320 is sold separately.

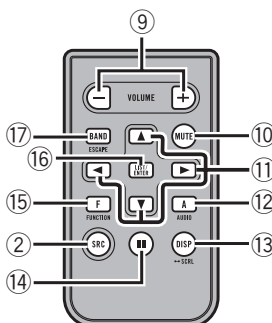

Part	Operation
⑨ +/- (VOLUME)	Press to increase or decrease volume.
⑩ MUTE	Press to mute. Press again to unmute.
⑪ ▲/▼/◀/▶	Press to perform manual seek tuning, fast forward, reverse and track search controls.
⑫ AUDIO	Press to display an audio function.
⑬ DISP/SCRL	Press to select different displays for the audio source. Press to select the basic screen or image screen for the video source. <ul style="list-style-type: none"> If the background setting on the entertainment menu is turned off, you can switch between the basic screen and image screen.
⑭	Press to pause or resume playback.
⑮ FUNCTION	Press to display functions.

Operating this unit

Part	Operation
⑮ LIST/ENTER	<p>Press to display the list depending on the source.</p> <p>While in the operating menu, press to control functions.</p>
⑰ BAND/ES-CAPE	<p>Press to select among three FM bands and MW/LW bands.</p> <p>When playing external storage devices containing a mixture of various media file types, press to switch between media file types to play.</p> <p>Music (compressed audio)—Video (DivX video files)—Photo (JPEG picture files)</p> <p>Press to return to the ordinary display from the list/function menu. Press to cancel the initial setting menu.</p>

Note

You cannot operate function settings, audio adjustments, list menus, etc. by pressing ▲/▼/◀/▶ of the remote control. Use multi-control of the head unit instead. 

Basic operations

Important

- Handle gently when removing or attaching the front panel.
- Avoid subjecting the front panel to excessive shock.
- Keep the front panel out of direct sunlight and high temperatures.
- To avoid damaging the device or vehicle interior, remove any cables and devices attached to the front panel before detaching it.

Removing the front panel to protect your unit from theft

- 1 Press the detach button to release the front panel.
- 2 Grab the front panel and remove.
- 3 Always keep the detached front panel in a protection device such as a protection case.

Re-attaching the front panel

- 1 Slide the front panel up until it clicks. The front panel and the head unit are connected on the upper side. Make sure that the front panel has been properly connected to the head unit.

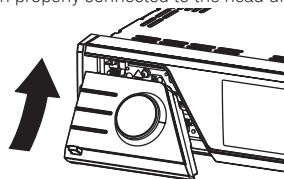

- 2 Press the lower side of the front panel until it is firmly seated. If you can't attach the front panel to the head unit successfully, try again. Forcing the front panel into place may result in damage.

Turning the unit on

- 1 Press **SRC/OFF** to turn the unit on.

Turning the unit off

- 1 Press and hold **SRC/OFF** until the unit turns off.

Selecting a source

- 1 Press **SRC/OFF** to cycle between:
 - Radio** (tuner)—**USB** (USB storage device)/**iPod** (iPod connected using USB input)—**SD** (SD memory card)—**AUX** (AUX)

Adjusting the volume

- 1 Turn **M.C.** to adjust the volume.

Note

When this unit's blue/white lead is connected to the vehicle's auto-antenna relay control terminal, the vehicle's antenna extends when this unit's source is turned on. To retract the antenna, turn the source off. 

Basic menu operations

You can operate source selection, list function, audio adjustment, etc., using **HOME**.

Operating this unit

1 Press HOME.

2 Push M.C. up or down to change the menu option.

Home (home menu)—**Custom** (custom menu)—**Phone** (phone menu)

- The phone menu is available only for MVH-8300BT.

3 Turn M.C. to select the menu option.

After selecting, perform the following procedures.

Home (home menu)

Source (selecting a source)

- 1 Press **M.C.** to display the setting mode.
- 2 Use **M.C.** to select the desired source name. Turn to change the source. Press to select. For the sources you can choose, refer to *Selecting a source* on the previous page.

List (operating a list menu)

- 1 Press **M.C.** to display the list. Press to display the folder list, file list or preset channel list depending on the source.

Audio (setting an audio menu)

- 1 Press **M.C.** to display the audio menu. Refer to *Audio Adjustments* on page 28.

System (setting a system menu)

- 1 Press **M.C.** to display the system menu. Refer to *System settings* on page 29.

Entertainment (setting an entertainment menu)

- 1 Press **M.C.** to display the entertainment menu. Refer to *Entertainment settings* on page 30.

Custom (custom menu)

You can choose menus within each menu (Audio function menu, etc.) and register them to this custom menu.

Refer to *Customizing menus* on this page.

Displaying the custom menu

- 1 Press **M.C.** to display the setting mode.

Phone (phone menu)

Displaying the phone menu

- Refer to *Phone menu operation* on page 26.

Menu operations identical for function settings/audio adjustments/initial settings/lists

Returning to the previous display

Returning to the previous list/category (the folder/category one level higher.)

- 1 Press **↶**.

Returning to the ordinary display

Canceling the initial setting menu

- 1 Press **HOME**.



Customizing menus

You can register frequently used menu items to a custom menu.

- The menu columns you can register are displayed in circular indicators.

1 Display the menu column to register.

Refer to *Basic menu operations* on the previous page.

You may display the menu column in **Home (home menu)**.

2 Push and hold M.C. right to register the menu column.

The menu columns you have registered are displayed in large, circular indicators.

3 Display the custom menu and choose a registered menu.

Refer to *Basic menu operations* on the previous page.

Note

You can register up to 12 columns.

Operating this unit

Canceling a Registered Menu

1 Display the custom menu and choose a registered menu.

Refer to *Basic menu operations* on page 9.

2 Push and hold **M.C.** right to cancel the registered menu.

About guide information

This unit displays guide information on how to use **M.C.** for each function.









1 Display the system menu.

Refer to *Basic menu operations* on page 9.

2 Use **M.C.** to select the Guide Info.

Turn to change the menu option. Press to select.

Guide information is displayed.

Operation	
	Turn M.C.
	Push M.C. up or down.
	Push M.C. left or right.
	Press M.C.
	Press and hold M.C.
	Push M.C. up.
	Push M.C. down.
	Push and hold M.C. up.

- Press **M.C.** to display the next page. 

Using Bluetooth telephone

This function is available only for MVH-8300BT.

Important

- Since this unit is on standby to connect with your cellular phone via Bluetooth wireless technology, using it without the engine running can drain the battery power.
- Operations may vary depending on the kind of cellular phone.
- Advanced operations that require attention such as dialing numbers on the monitor, using the phone book, etc., are prohibited while driving. Park your vehicle in a safe place when using these advanced operations.

Setting up for hands-free phoning

Before you can use the hands-free phoning function you must set up the unit for use with your cellular phone.

- 1 Connection
Operate the Bluetooth telephone connection menu. Refer to *Connection menu operation* on page 25.
- 2 Function settings
Operate the Bluetooth telephone function menu. Refer to *Phone menu operation* on page 26.

Basic operations

- | |
|--|
| <p>Making a phone call</p> <ol style="list-style-type: none"> 1 Refer to <i>Phone menu operation</i> on page 26. |
| <p>Answering an incoming call</p> <ol style="list-style-type: none"> 1 When a call is received, press M.C. <ul style="list-style-type: none"> • You can also perform this operation by pushing M.C. up. |
| <p>Ending a call</p> <ol style="list-style-type: none"> 1 Press M.C. |
| <p>Rejecting an incoming call</p> <ol style="list-style-type: none"> 1 When a call is received, push M.C. down. |
| <p>Answering a call waiting</p> <ol style="list-style-type: none"> 1 When a call is received, press M.C. <ul style="list-style-type: none"> • You can also perform this operation by pushing M.C. up. |

Switching between callers on hold ① Push M.C. up.
Canceling call waiting ① Push M.C. down.
Adjusting the other party's listening volume ① Push M.C. left or right while talking on the phone.
Turning private mode on or off ① Push and hold M.C. up while talking on the phone.

Notes

- If private mode is selected on the cellular phone, hands-free phoning may not be available.
- The estimated call time appears in the display (this may differ slightly from the actual call time). ■

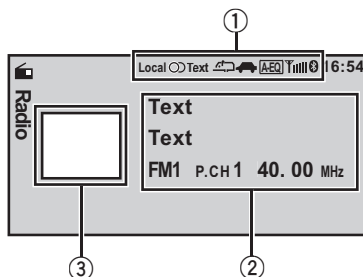
Radio**Basic operations**

- ① Indicator display area
Refer to *Indicator list* on page 41.
- ② Text information area
 - PTY name
 - Program service name
 - Band/Preset number/Frequency indicator
- ③ Source image display

Manual tuning (step by step)

- ① Push **M.C.** left or right.

Seeking

- ① Push and hold **M.C.** left or right, and then release.
You can cancel seek tuning by pushing **M.C.** left or right.
While pushing and holding **M.C.** left or right, you can skip stations. Seek tuning starts as soon as you release **M.C.**

Note

This unit's AF (alternative frequencies search) function can be turned on and off. AF should be off for normal tuning operation (refer to the next page).

Operating this unit

Using PI Seek

If the tuner cannot find a suitable station, or the reception status deteriorates, the unit automatically searches for a different station with the same programming. During the search, **PI SEEK** is displayed and the sound is muted.

Using Auto PI Seek for preset stations

When preset stations cannot be recalled, the unit can be set to perform PI Seek during preset recall.

- The default setting for Auto PI Seek is off. Refer to **Auto PI** (*auto PI seek*) on page 31.

Storing and recalling stations for each band

Using the preset screen

- 1 Push **M.C.** up or down to display the preset screen.
- 2 Push **M.C.** up or down until the desired band (**FM1**, **FM2**, **FM3** for FM or **MW/LW**) is displayed.
- 3 Use **M.C.** to store the selected frequency in the memory.
Turn to change the preset number. Press and hold to store.
- 4 Use **M.C.** to select the desired station.
Turn to change the station. Press to select.
You can also display the preset screen by pressing **HOME**. Refer to *Basic menu operations* on page 9.

Function settings

1 Press M.C. to display the function menu.

2 Turn M.C. to select the function.

After selecting, perform the following procedures to set the function.

BSM (best stations memory)

BSM (best stations memory) automatically stores the six strongest stations in the order of their signal strength.

- 1 Press **M.C.** to turn BSM on.
To cancel, press **M.C.** again.

Regional (regional)

When AF is used, the regional function limits the selection of stations to those broadcasting regional programs.

- 1 Press **M.C.** to turn the regional function on or off.

Local (local seek tuning)

Local seek tuning lets you tune in to only those radio stations with sufficiently strong signals for good reception.

- 1 Press **M.C.** to display the setting mode.
- 2 Turn **M.C.** to select the desired setting.
FM: **Off—Level1—Level2—Level3—Level4**
MW/LW: **Off—Level1—Level2**

The highest level setting allows reception of only the strongest stations, while lower levels allow the reception of weaker stations.

- 3 Press **M.C.** to confirm the selection.

PTY search (program type selection)

You can tune in to a station using PTY (program type) information.

- 1 Press **M.C.** to display the setting mode.
- 2 Turn **M.C.** to select the desired setting.
News&Info—Popular—Classics—Others
- 3 Press **M.C.** to begin the search.

The unit searches for a station broadcasting that type of program. When a station is found, its program service name is displayed.

PTY (program type ID code) information is listed in the following section. Refer to the next page.

The program of some stations may differ from that indicated by the transmitted PTY.

If no station is broadcasting the type of program you searched for, **Not Found** is displayed for about four seconds and then the tuner returns to the original station.

Traffic Announce (traffic announcement standby)

Regardless of the source you are listening to, you can receive traffic announcements automatically with TA (traffic announcement standby).

- 1 Press **M.C.** to turn traffic announcement standby on or off.

Alternative FREQ (alternative frequencies search)

Operating this unit

When the tuner cannot get a good reception, the unit automatically searches for a different station in the same network.

- 1 Press **M.C.** to turn AF on or off.

News Interrupt (news program interruption)

When a news program is broadcast from a PTY code news station, the unit automatically switches to the news broadcast station. When the news program ends, reception of the previous program resumes.

- 1 Press **M.C.** to turn the NEWS function on or off.

Radio Text (displaying radio text)

Radio text data transmitted by RDS stations, such as station information, the name of the currently broadcast song and the name of the artist, can be displayed on this tuner.

- The tuner automatically stores the three latest radio text broadcasts received, replacing the oldest text with the newest text.
- 1 Press **M.C.** to display radio text.
Radio text for the currently broadcasting station is displayed.

- 2 Turn **M.C.** to recall the three most recent radio texts.
Refer to *Storing and recalling radio text* on this page.

If there is no radio text data in the memory, the display will not change.

Note

If MW/LW band is selected, only **BSM** or **Local** is available.

Storing and recalling radio text

You can store data from up to six radio text.

1 Display the radio text you want to store in the memory.

Refer to **Radio Text** (*displaying radio text*) on this page.

2 Press M.C.

The preset screen is displayed.

3 Use M.C. to store the selected radio text in the memory.

Turn to change the preset number. Press and hold to store.

4 Use M.C. to select the desired radio text.

Turn to change the radio text. Press to select.

PTY list

News&Info

News (News), **Affairs** (Current affairs), **Info** (Information), **Sport** (Sports), **Weather** (Weather), **Finance** (Finance)

Popular

Pop Mus (Popular music), **Rock Mus** (Rock music), **Easy Mus** (Easy listening), **Oth Mus** (Other music), **Jazz** (Jazz), **Country** (Country music), **Nat Mus** (National music), **Oldies** (Oldies music), **Folk mus** (Folk music)

Classics

L. Class (Light classical), **Classic** (Classical)

Others

Educate (Education), **Drama** (Drama), **Culture** (Culture), **Science** (Science), **Varied** (Varied), **Children** (Children's), **Social** (Social affairs), **Religion** (Religion), **Phone In** (Phone in), **Touring** (Travel), **Leisure** (Leisure), **Document** (Documentaries)



Operating this unit

Playing moving images

Basic operations

If an iPod with video capabilities is connected to this unit using an interface cable such as the CD-IU50V (sold separately), you can enjoy the video contents of the iPod as an **iPod** source. You need not change the **AUX** setting.

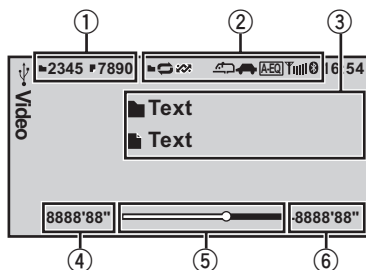

You can switch to the basic screen or the image screen.

Refer to **Display** (*display setting*) on page 17.

- ① File information area for the currently playing file

External storage device (USB, SD)

- Folder/file number indicator

iPod

- Song number indicator

- ② Indicator display area

Refer to *Indicator list* on page 41.

- ③ Text information area

External storage device (USB, SD)

- Folder name
- File name

iPod

- Song title
- Artist name
- Album title

- ④ Play time indicator

- ⑤ Scrubber bar

- ⑥ Remaining time indicator

Playing files on a USB storage device

- 1 Open the USB port cover.
- 2 Plug in the USB storage device using a USB cable.

Stopping playback of files on a USB storage device

- 1 You may disconnect the USB storage device at any time.

Playing files on an SD memory card

- 1 Remove the front panel.
- 2 Insert an SD memory card into the SD card slot. Insert it with the contact surface facing down, and press on the card until it clicks and completely locks into place.
- 3 Re-attach the front panel.

Stopping playback of files on an SD memory card

- 1 Remove the front panel.
- 2 Press on the SD memory card until it clicks. The SD memory card is ejected.
- 3 Pull out the SD memory card.
- 4 Re-attach the front panel.

Playing videos on an iPod

- 1 Open the USB port cover.
- 2 With an interface cable (e.g., CD-IU50V), connect the iPod to a USB cable and AUX input using the iPod Dock Connector.

Selecting a folder

- 1 Push **M.C.** up or down.

Selecting a file (chapter)

- 1 Push **M.C.** left or right.

Fast forwarding or reversing

- 1 Push and hold **M.C.** left or right.

Notes

- Disconnect USB storage devices from the unit when not in use.
- Incompatible text stored with the video image file may not be displayed or may be displayed incorrectly.
- Incompatible text saved on the iPod will not be displayed by the unit.
- Disconnect headphones from the iPod before connecting it to this unit.
- The iPod cannot be turned on or off unless the control mode is set to **App**.
- The iPod will turn off about two minutes after the ignition switch is set to OFF.

Operating this unit

- When playing external storage devices that contain a mixture of various media file types, switch between media file types when playing different files.
Refer to **A/V Format** (*switching media file types*) on the next page.

Selecting and playing files from the name list

1 Display the list menu.

Refer to *Basic menu operations* on page 9.

2 Use M.C. to select the desired file name (or folder name).

Changing the file or folder name ① Turn M.C.
Playing ① When a file is selected, press M.C.
Viewing a list of the files (or folders) in the selected folder ① When a folder is selected, press M.C.
Changing the file or folder name (skip 100 items at once) ① Push M.C. up or down.
Changing the file or folder name (automatically skip 100 items each time) ① Push and hold M.C. up or down.

Browsing for a video on the iPod

1 Display the list menu.

Refer to *Basic menu operations* on page 9.

2 Use M.C. to select a category/video.

Changing the name of the video or category ① Turn M.C.
Playing ① When a video is selected, press M.C.
Viewing a list of the files (or folders) in the selected folder ① When a category is selected, press M.C.

Searching the list by alphabet

- ① When a list for the selected category is displayed, push and hold **M.C.** left or right to switch to alphabet search mode.
- ② Turn **M.C.** to select a letter.
- ③ Press **M.C.** to display the alphabetical list.

Changing the name of the video (skip 100 items at once)

- ① Push **M.C.** up or down.

Changing the name of the video (automatically skip 100 items each time)

- ① Push and hold **M.C.** up or down.

Playing DivX® VOD content

Some DivX VOD (video on demand) content may only be playable a fixed number of times. When you attempt to play back this type of content saved on an external storage device, the remaining number of times it can be played is shown on-screen. You can then decide whether or not to play back the contents of the external storage device.

- If there is no limit to the number of times the DivX VOD content can be viewed, then you may insert the external storage device into your player and play the content as often as you like, and no message will be displayed.
- You can confirm the number of times that the content can be played by checking the number displayed after **Remaining Views**:

Important

- In order to play DivX VOD contents on this unit, you first need to register the unit with your DivX VOD contents provider. For details on your registration code, refer to *Displaying the DivX® VOD registration code* on page 36.
- DivX VOD content is protected by a DRM (Digital Rights Management) system. This restricts playback of content to specific, registered devices.

Operating this unit

- If a message is displayed after inserting the external storage device containing DivX VOD content, use M.C. to select a desired mode.

Turn to change the mode. Press to select.

- **Play** – Playback of the DivX VOD content
- **Next Play** – Skip to the next file
- **Stop** – If you do not want to play the DivX VOD content

Function settings

1 Press M.C. to display the function menu.

2 Turn M.C. to select the function.

After selecting, perform the following procedures to set the function.

External storage device (USB, SD)

Play/Pause (play/pause)

- 1 Press **M.C.** to display the setting mode.
- 2 Turn **M.C.** to select the desired setting.
Play—Pause
- 3 Press **M.C.** to confirm the selection.

Play Mode (repeat play)

- 1 Press **M.C.** to display the setting mode.
- 2 Turn **M.C.** to select a repeat play range.
 - **All** – Repeat all files
 - **File** – Repeat the current file
 - **Folder** – Repeat the current folder
- 3 Press **M.C.** to confirm the selection.

Stop (stopping playback)

- 1 Press **M.C.** to stop playback.

Time Search (time search)

- 1 Press **M.C.** to display the setting mode.
- 2 Turn **M.C.** to find the part you want to play.
- 3 Press **M.C.** to confirm the selection.

Wide Mode (switching the wide mode)

- 1 Press **M.C.** to display the setting mode.
- 2 Turn **M.C.** to select the desired setting.
Full (full)—**Just** (just)—**Cinema** (cinema)—**Zoom** (zoom)—**Normal** (normal)
For details about the settings, refer to *Changing the wide screen mode* on page 36.
- 3 Press **M.C.** to confirm the selection.

Display (display setting)

You can switch to the basic screen or the image screen.

- 1 Press **M.C.** to display the setting mode.
- 2 Press **M.C.** to select the desired setting.

A/V Format (switching media file types)

- 1 Press **M.C.** to display the setting mode.
- 2 Turn **M.C.** to select the desired setting.
Music (compressed audio)—**Video** (DivX video files)—**Photo** (JPEG picture files)
- 3 Press **M.C.** to confirm the selection.

DivX® Subtitle (DivX subtitle file settings)

- 1 Press **M.C.** to display the setting mode.
- 2 Turn **M.C.** to select the desired setting.
Original (DivX subtitles) — **Custom** (DivX external subtitles)
For details about the settings, refer to *Setting the DivX subtitle file* on page 36.
- 3 Press **M.C.** to confirm the selection.

TV Aspect (aspect ratio settings)

- 1 Press **M.C.** to display the setting mode.
- 2 Turn **M.C.** to select the desired setting.
16 : 9 — **Letter Box** — **Pan Scan**
For details about the settings, refer to *Setting the aspect ratio* on page 36.
- 3 Press **M.C.** to confirm the selection.

DivX® VOD (DivX® VOD registration code)

- 1 Press **M.C.** to display the setting mode.
- 2 Use **M.C.** to display the desired code.
Turn to change the menu option. Press to select.
Registration – Refer to *Displaying the DivX® VOD registration code* on page 36.
Deregistration – Refer to *Displaying the deregistration code* on page 37.

Audio Lang. (audio language settings)

Operating this unit

You can switch the audio language during playback when playing a file recorded with dialog in two or more languages.

- 1 Press **M.C.** to display the setting mode.
- 2 Turn **M.C.** to select the desired setting.
- 3 Press **M.C.** to confirm the selection.

Subtitle Lang. (subtitle language settings)

You can switch subtitle language during playback when playing a file recorded with subtitles in one or more languages.

- 1 Press **M.C.** to display the setting mode.
- 2 Turn **M.C.** to select the desired setting.
- 3 Press **M.C.** to confirm the selection.

iPod

Play/Pause (pause)

- 1 Press **M.C.** to pause or resume.

Shuffle Mode (shuffle)

- 1 Press **M.C.** to display the setting mode.
- 2 Turn **M.C.** to select your favorite setting.
 - **Songs** – Play back songs in the selected list in random order.
 - **Albums** – Play back songs from a randomly selected album in order.
 - **Off** – Cancel random play.
- 3 Press **M.C.** to confirm the selection.

Play Mode (repeat play)

- 1 Press **M.C.** to display the setting mode.
- 2 Turn **M.C.** to select a repeat play range.
 - **One** – Repeat the current song
 - **All** – Repeat all songs in the selected list
- 3 Press **M.C.** to confirm the selection.

Control Mode (control mode)

This function is not compatible with the following iPod models.

- iPod nano 1st generation
 - iPod 5th generation
- 1 Press **M.C.** to select your favorite setting.
 - **App** – This unit's iPod function can be operated from the connected iPod.
 - **Audio** – This unit's iPod function can be operated from this unit.

Time Search (time search)

- 1 Press **M.C.** to display the setting mode.
- 2 Turn **M.C.** to find the part you want to play.
- 3 Press **M.C.** to confirm the selection.

Wide Mode (switching the wide mode)

- 1 Press **M.C.** to display the setting mode.
- 2 Turn **M.C.** to select the desired setting.

Full (full)—**Just** (just)—**Cinema** (cinema)—**Zoom** (zoom)—**Normal** (normal)

For details about the settings, refer to *Changing the wide screen mode* on page 36.
- 3 Press **M.C.** to confirm the selection.

Display (display setting)

You can switch to the basic screen or the image screen.

- 1 Press **M.C.** to display the setting mode.
- 2 Press **M.C.** to select the desired setting.

ABC Search (alphabet search mode setting)

When this setting is on, you can switch to alphabet search mode by turning **M.C.** twice while using the browse function of the iPod. Refer to *Searching the list by alphabet* on page 16.

- 1 Press **M.C.** to turn the setting for when **M.C.** is turned twice on or off.

Sound Retriever (sound retriever)

Automatically enhances compressed audio and restores rich sound.

- 1 Press **M.C.** to display the setting mode.
- 2 Turn **M.C.** to select the desired setting.

Off (off)—**1**—**2**

1 is effective for low compression rates, and **2** is effective for high compression rates.
- 3 Press **M.C.** to confirm the selection.

Notes

- Switching the control mode to **App** pauses song playback. Operate the iPod to resume playback.
- The following functions are still accessible from the unit even if the control mode is set to **App**.
 - Volume, fast forward/reverse, track up/down, pausing
- When the control mode is set to **App**, operations are limited as follows:

Operating this unit

- Only **Play/Pause** (pause), **Control Mode** (control mode), **Wide Mode** (switching the wide mode) and **Display** (display setting) functions are available.
- The browse function cannot be operated from this unit.
- You can select the following functions if the background setting on the entertainment menu is off.
 - **Wide Mode** (switching the wide mode)
 - **Display** (display setting)
 - **DivX® Subtitle** (DivX subtitle file settings)
 - **TV Aspect** (aspect ratio settings)
 - **Subtitle Lang.** (subtitle language settings)

Playing audio

Basic operations

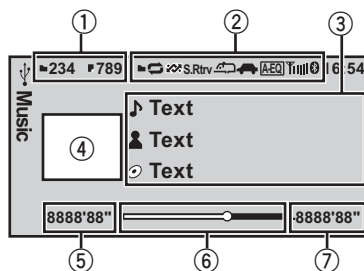

- ① File information area for the currently playing file

External storage device (USB, SD)

- Folder/file number indicator

iPod

- Song number indicator

- ② Indicator display area

Refer to *Indicator list* on page 41.

- ③ Text information area

External storage device (USB, SD)

- Song title/artist name/album title—
folder/file name

iPod

- Song title
- Artist name
- Album title

- ④ Artwork/Source image display area

iPod

- Artwork display or Source image display

External storage device (USB, SD)

- Source image display

- ⑤ Play time indicator

- ⑥ Scrubber bar

- ⑦ Remaining time indicator

Playing songs on a USB storage device

- ① Open the USB port cover.
- ② Plug in the USB storage device using a USB cable.

Stopping playback of files on a USB storage device

- ① You may disconnect the USB storage device at any time.

Operating this unit

Playing songs on an SD memory card

- 1 Remove the front panel.
- 2 Insert an SD memory card into the SD card slot. Insert it with the contact surface facing down, and press on the card until it clicks and completely locks into place.
- 3 Re-attach the front panel.

Stopping playback of files on an SD memory card

- 1 Remove the front panel.
- 2 Press on the SD memory card until it clicks. The SD memory card is ejected.
- 3 Pull out the SD memory card.
- 4 Re-attach the front panel.

Playing songs on an iPod

- 1 Open the USB port cover.
- 2 Connect an iPod to the USB cable using an iPod Dock Connector.

Selecting a folder

- 1 Push **M.C.** up or down.

Selecting a track (chapter)

- 1 Push **M.C.** left or right.

Fast forwarding or reversing

- 1 Push and hold **M.C.** left or right.

Notes

- Disconnect USB storage devices from the unit when not in use.
- Depending on the version of iTunes used to write MP3 files to a disc or media file types, incompatible text stored within an audio file may be displayed incorrectly.
- Disconnect headphones from the iPod before connecting it to this unit.
- The iPod cannot be turned on or off unless the control mode is set to **App**.
- The iPod will turn off about two minutes after the ignition switch is set to OFF.

Selecting and playing files/tracks from the name list

Operations are the same as those for moving images. (Refer to *Selecting and playing files from the name list* on page 16.)

The following operation is available.

Playing a song in the selected folder

- 1 When a folder is selected, press and hold **M.C.**

Browsing for a song on the iPod

Operations are the same as those for moving images. (Refer to *Browsing for a video on the iPod* on page 16.)

The following operation is available.

Playing a song in the selected category

- 1 When a category is selected, press and hold **M.C.**

However, the categories in the top tier are different from those for moving images.

- **Video** (video)
- **Playlists** (playlists)
- **Artists** (artists)
- **Albums** (albums)
- **Songs** (songs)
- **Podcasts** (podcasts)
- **Genres** (genres)
- **Composers** (composers)
- **Audiobooks** (audiobooks)

Function settings

1 Press M.C. to display the function menu.

2 Turn M.C. to select the function.

After selecting, perform the following procedures to set the function.

External storage device (USB, SD)

Play/Pause (pause)

- 1 Press **M.C.** to pause or resume.

Random (random play)

- 1 Press **M.C.** to turn random play on or off.

Play Mode (repeat play)

Operating this unit

- 1 Press **M.C.** to display the setting mode.
- 2 Turn **M.C.** to select a repeat play range.
 - **All** – Repeat all files
 - **File** – Repeat the current file
 - **Folder** – Repeat the current folder
- 3 Press **M.C.** to confirm the selection.

Sound Retriever (sound retriever)

Automatically enhances compressed audio and restores rich sound.

- 1 Press **M.C.** to display the setting mode.
- 2 Turn **M.C.** to select the desired setting.
Off (off)—1—2
1 is effective for low compression rates, and 2 is effective for high compression rates.
- 3 Press **M.C.** to confirm the selection.

Time Search (time search)

- 1 Press **M.C.** to display the setting mode.
- 2 Turn **M.C.** to find the part you want to play.
- 3 Press **M.C.** to confirm the selection.

Display (display setting)

You can switch to the desired text information.

- 1 Press **M.C.** to display the setting mode.
- 2 Press **M.C.** to select the desired setting.

A/V Format (switching media file types)

- 1 Press **M.C.** to display the setting mode.
- 2 Turn **M.C.** to select the desired setting.
Music (compressed audio)—**Video** (DivX video files)—**Photo** (JPEG picture files)
- 3 Press **M.C.** to confirm the selection.

iPod

Play/Pause (pause)

- 1 Press **M.C.** to pause or resume.

Shuffle All (shuffle all)

- 1 Press **M.C.** to turn shuffle all on.
To turn off, set **Shuffle Mode** in the **Function** menu to off.

Shuffle Mode (shuffle)

- 1 Press **M.C.** to display the setting mode.
- 2 Turn **M.C.** to select your favorite setting.
 - **Songs** – Play back songs in the selected list in random order.
 - **Albums** – Play back songs from a randomly selected album in order.
 - **Off** – Cancel random play.
- 3 Press **M.C.** to confirm the selection.

Play Mode (repeat play)

- 1 Press **M.C.** to display the setting mode.
- 2 Turn **M.C.** to select a repeat play range.
 - **One** – Repeat the current song
 - **All** – Repeat all songs in the selected list
- 3 Press **M.C.** to confirm the selection.

Link Search (link search)

You can play songs from the following lists.

- Album list of the currently playing artist
 - Song list of the currently playing album
 - Album list of the currently playing genre
- 1 Press **M.C.** to display the setting mode.
 - 2 Turn **M.C.** to change the mode; press to select.
 - **Artists** – Displays the album list of currently playing artist.
 - **Albums** – Displays a song list from the album currently being played.
 - **Genres** – Displays an album list from the genre currently being played.
 - 3 Use **M.C.** to select an album or song from the list.
For more details about the selection operation, refer to *Browsing for a video on the iPod* on page 16.

Control Mode (control mode)

This function is not compatible with the following iPod models.

- iPod nano 1st generation
 - iPod 5th generation
- 1 Press **M.C.** to select your favorite setting.
 - **App** – This unit's iPod function can be operated from the connected iPod.
 - **Audio** – This unit's iPod function can be operated from this unit.

Audiobooks (changing of audiobook speed)

Operating this unit

- 1 Press **M.C.** to display the setting mode.
- 2 Turn **M.C.** to select your favorite setting.
 - **Faster** – Playback at a speed faster than normal
 - **Normal** – Playback at normal speed
 - **Slower** – Playback at a speed slower than normal
- 3 Press **M.C.** to confirm the selection.

Sound Retriever (sound retriever)

Automatically enhances compressed audio and restores rich sound.

- 1 Press **M.C.** to display the setting mode.
- 2 Turn **M.C.** to select the desired setting.

Off (off)—1—2

1 is effective for low compression rates, and **2** is effective for high compression rates.
- 3 Press **M.C.** to confirm the selection.

Time Search (time search)

- 1 Press **M.C.** to display the setting mode.
- 2 Turn **M.C.** to find the part you want to play.
- 3 Press **M.C.** to confirm the selection.

ABC Search (alphabet search mode setting)

When this setting is on, you can switch to alphabet search mode by turning **M.C.** twice while using the browse function of the iPod. Refer to *Searching the list by alphabet* on page 16.

- 1 Press **M.C.** to turn the setting for when **M.C.** is turned twice on or off.

Notes

- Switching the control mode to **App** pauses song playback. Operate the iPod to resume playback.
- The following functions are still accessible from the unit even if the control mode is set to **App**.
 - Volume, fast forward/reverse, track up/down, pausing
- When the control mode is set to **App**, operations are limited as follows:
 - Only **Play/Pause** (pause), **Control Mode** (control mode), **Wide Mode** (switching the wide mode) and **Display** (display setting) functions are available.
 - The browse function cannot be operated from this unit.

Playing still images

When a USB/SD device that contains JPEG picture files is connected, this unit starts a slideshow from the first folder/picture on the device. The player displays the pictures in each folder in alphabetical order.

Basic operations

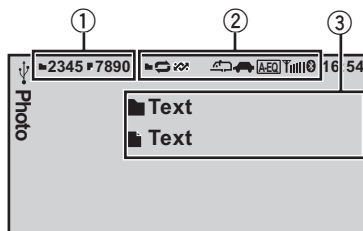

You can switch to the basic screen or the image screen.

Refer to **Display** (*display setting*) on the next page.

- 1 Folder/file number indicator
- 2 Indicator display area
Refer to *Indicator list* on page 41.
- 3 Text information area
 - Folder name
 - File name

Playing files on a USB storage device

- 1 Open the USB port cover.
- 2 Plug in the USB storage device using a USB cable.

Stopping playback of files on a USB storage device

- 1 You may disconnect the USB storage device at any time.

Playing files on an SD memory card

- 1 Remove the front panel.
- 2 Insert an SD memory card into the SD card slot. Insert it with the contact surface facing down, and press on the card until it clicks and completely locks into place.
- 3 Re-attach the front panel.

Operating this unit

Stopping playback of files on an SD memory card

- 1 Remove the front panel.
- 2 Press on the SD memory card until it clicks.
The SD memory card is ejected.
- 3 Pull out the SD memory card.
- 4 Re-attach the front panel.

Selecting a folder

- 1 Push **M.C.** up or down.

Selecting a file

- 1 Push **M.C.** left or right.

Searching every 10 files

- 1 Push and hold **M.C.** left or right.

Notes

- Disconnect USB storage devices from the unit when not in use.
- Incompatible text stored with the video image file may not be displayed or may be displayed incorrectly.
- When playing external storage devices that contain a mixture of various media file types, switch between media file types when playing different files.

For details about the settings, refer to

A/V Format (*switching media file types*) on page 21.

Selecting and playing files from the name list

Operations are the same as those for moving images. (Refer to *Selecting and playing files from the name list* on page 16.)

Function settings

1 Press M.C. to display the function menu.

2 Turn M.C. to select the function.

After selecting, perform the following procedures to set the function.

Play/Pause (pause)

- 1 Press **M.C.** to pause or resume.

Random (random play)

- 1 Press **M.C.** to turn random play on or off.

Play Mode (repeat play)

- 1 Press **M.C.** to display the setting mode.
- 2 Turn **M.C.** to select a repeat play range.
 - **All** – Repeat all files
 - **Folder** – Repeat the current folder
- 3 Press **M.C.** to confirm the selection.

Capture (capturing an image in JPEG files)

You can capture image data and use it as wallpaper. Images can be stored and recalled easily in this unit.

- Only one image can be stored on this unit. Old images are overwritten with the new ones.

- 1 Press **M.C.** to display the setting mode.
- 2 Turn **M.C.** to select the desired setting.
- 3 Press **M.C.** to confirm the selection.

Rotate (picture rotation)

- 1 Press **M.C.** to display the setting mode.
- 2 Press **M.C.** to rotate the displayed picture 90° clockwise.

Wide Mode (switching the wide mode)

- 1 Press **M.C.** to display the setting mode.
- 2 Turn **M.C.** to select the desired setting.

Full (full)—**Just** (just)—**Cinema** (cinema)—**Zoom** (zoom)—**Normal** (normal)

For details about the settings, refer to *Changing the wide screen mode* on page 36.
- 3 Press **M.C.** to confirm the selection.

Time Per Slide (slideshow interval time setting)

JPEG files can be viewed as a slide show on this unit. In this setting, the interval between each image can be set.

- 1 Press **M.C.** to display the setting mode.
- 2 Turn **M.C.** to select the desired setting.
 - **5sec** – JPEG images switch at intervals of 5 seconds
 - **10sec** – JPEG images switch at intervals of 10 seconds
 - **15sec** – JPEG images switch at intervals of 15 seconds
 - **Manual** – JPEG images can be switched manually
- 3 Press **M.C.** to confirm the selection.

Display (display setting)

Operating this unit

You can switch to the basic screen or the image screen.

- 1 Press **M.C.** to display the setting mode.
- 2 Press **M.C.** to select the desired setting.

A/V Format (switching media file types)

- 1 Press **M.C.** to display the setting mode.
- 2 Turn **M.C.** to select the desired setting.
For details about the settings, refer to **A/V Format** (switching media file types) on page 21.
- 3 Press **M.C.** to confirm the selection.

Note

You can select the following functions if the background setting on the entertainment menu is off.

- **Capture** (capturing an image in JPEG files)
- **Rotate** (picture rotation)
- **Wide Mode** (switching the wide mode)
- **Display** (display setting)

Introduction of operations for playback of still images as a slideshow

You can view still images saved to a USB/SD as a slideshow while listening to audio from another source.

For details about the settings, refer to **Slide Show** (slide show viewing) on page 30.

Function settings

1 Press M.C. to display the function menu.

2 Turn M.C. to select the function.

After selecting, perform the following procedures to set the function.

Return (ending slideshow)

- 1 Press **M.C.** to end the slideshow.

Photo Selection (selecting photos)

- 1 Press **M.C.** to display the setting mode.
- 2 Select a file.

The following operations are available. The operating method is the same as that for the basic operations. Refer to *Basic operations* on page 22.

- Selecting a folder
- Selecting a file
- Searching every 10 files

Play/Pause (pause)

- 1 Press **M.C.** to pause or resume.

Random (random play)

- 1 Press **M.C.** to turn random play on or off.

Play Mode (repeat play)

- 1 Press **M.C.** to display the setting mode.
- 2 Turn **M.C.** to select a repeat play range.
 - **All** – Repeat all files
 - **Folder** – Repeat the current folder
- 3 Press **M.C.** to confirm the selection.

Capture (capturing an image in JPEG files)

For details about the settings, refer to **Capture** (capturing an image in JPEG files) on the previous page.

- 1 Press **M.C.** to display the setting mode.
- 2 Turn **M.C.** to select the desired setting.
- 3 Press **M.C.** to confirm the selection.

Rotate (picture rotation)

- 1 Press **M.C.** to display the setting mode.
- 2 Press **M.C.** to rotate the displayed picture 90° clockwise.

Wide Mode (switching the wide mode)

- 1 Press **M.C.** to display the setting mode.
- 2 Turn **M.C.** to select the desired setting.
Full (full)—**Just** (just)—**Cinema** (cinema)—**Zoom** (zoom)—**Normal** (normal)
For details about the settings, refer to *Changing the wide screen mode* on page 36.
- 3 Press **M.C.** to confirm the selection.

Time Per Slide (slideshow interval time setting)

For details about the settings, refer to **Time Per Slide** (slideshow interval time setting) on the previous page.

- 1 Press **M.C.** to display the setting mode.
- 2 Turn **M.C.** to select the desired setting.
- 3 Press **M.C.** to confirm the selection.

Operating this unit

Note

When the USB or SD source is selected, this unit cannot view still images on USB/SD as a slideshow. 

Bluetooth Telephone

This function is available only for *MVH-8300BT*. For details on basic operations after connecting to a cellular phone, refer to *Using Bluetooth telephone* on page 11.

- PIN code is set to **0000** as the default. You can change this code. Refer to **PIN Code (PIN code input)** on the next page.

Connection menu operation

Important

Be sure to park your vehicle in a safe place and apply the parking brake when performing this operation.

1 Display the phone menu.

Refer to *Basic menu operations* on page 9.

2 Use M.C. to select Connection.

Turn to change the menu option. Press to select.

3 Turn M.C. to select the function.

After selecting, perform the following procedures to set the function.

Device List (connecting or disconnecting a cellular phone from the device list)

- 1 Press **M.C.** to display the setting mode.
- 2 Turn **M.C.** to select the name of a device you want to connect.
- 3 Press and hold **M.C.** to switch the Bluetooth device address and device name.
- 4 Press **M.C.** to connect the selected cellular phone.
While connecting, the circular indicator flashes. To complete the connection, check the device name (**MVH-8300BT**) and enter the PIN code on your cellular phone. If the connection is established, a circular indicator appears next to the device name.

Delete Device (deleting a cellular phone from the device list)

Operating this unit

- 1 Press **M.C.** to display the setting mode.
- 2 Turn **M.C.** to select the name of a device you want to delete.
- 3 Press **M.C.** to select the device you want to delete. Press and hold **M.C.** to switch the Bluetooth device address and device name.
- 4 Use **M.C.** to select **Yes**. Turn to change the menu option. Press to select. To cancel, select **No**.
 - While this function is in use, do not turn off the engine.

Add Device (connecting a new cellular phone)

- 1 Press **M.C.** to start searching.
 - To cancel, press **M.C.** while searching.
- 2 Turn **M.C.** to select a device from the device list.
 - If the desired device is not displayed, select **Search Again**.
 - If five devices are already paired, **Memory Full** is displayed and it is not possible to perform this operation. In this case, delete a paired device first.
- 3 Press and hold **M.C.** to switch the Bluetooth device address and device name.
- 4 Press **M.C.** to connect the selected cellular phone. While connecting, **Pairing** flashes. To complete the connection, check the device name (**MVH-8300BT**) and enter the PIN code on your cellular phone. If the connection is established, **Paired** is displayed and the phone menu appears.

Special Device (setting a special device)

Bluetooth devices that are difficult to establish a connection with are called special devices. If your Bluetooth device is listed as a special device, select the appropriate one.

- 1 Press **M.C.** to display the setting mode.
- 2 Use **M.C.** to select a special device. Turn to change the menu option. Press to select.
- 3 Use a cellular phone to connect to this unit. To complete the connection, check the device name (**MVH-8300BT**) and enter the PIN code on your cellular phone. If the connection is established, a circular indicator appears next to the device name.
 - If five devices are already paired, **Memory Full** is displayed and it is not possible to perform this operation. In this case, delete a paired device first.

Auto Connect (connecting to a Bluetooth device automatically)

- 1 Press **M.C.** to turn automatic connection on or off.

Visibility (setting the visibility of this unit)

To check the availability of this unit from other devices, Bluetooth visibility of this unit can be turned on.

- 1 Press **M.C.** to turn the visibility of this unit on or off.
 - While setting **Special Device**, Bluetooth visibility of this unit is turned on temporarily.

Device Information (Bluetooth device address display)

- 1 Press **M.C.** to display the Bluetooth device address and device name.

PIN Code (PIN code input)

To connect your cellular phone to this unit via Bluetooth wireless technology, you need to enter a PIN code on your phone to verify the connection. The default code is **0000**, but you can change it with this function.

- 1 Press **M.C.** to display the setting mode.
- 2 Turn **M.C.** to select a number.
- 3 Press **M.C.** to move the cursor to the next position.
- 4 After inputting the PIN code (up to 8 digits), press **M.C.**

The PIN code can be stored in the memory.

- When you press and hold **M.C.** in the same display, the PIN code you entered is stored in this unit.
- Pressing **M.C.** in the confirmation display returns you to the PIN code input display, and you can change the PIN code.

Phone menu operation

Important

Be sure to park your vehicle in a safe place and apply the parking brake when performing this operation.

1 Display the phone menu.

Refer to *Basic menu operations* on page 9.

2 Turn M.C. to select the function.

After selecting, perform the following procedures to set the function.

Operating this unit

Recent (recent call history)

You can make a phone call by selecting from dialed calls, received calls, and missed calls in this menu.

- 1 Press **M.C.** to display **Missed Calls** (missed call history), **Dialed Calls** (dialed call history) or **Received Calls** (received call history).
- 2 Use **M.C.** to select the desired list.
Turn to change the menu option. Press to select.
- 3 Press **M.C.** to make a call.
- 4 When you find a phone number that you want to store in the memory, press and hold **M.C.** right.

Phone Book (phone book)

- The phone book in your cellular phone will be transferred automatically when the phone is connected to this unit.
- Depending on the cellular phone, the phone book may not be transferred automatically. In this case, operate your cellular phone to transfer the phone book. The visibility of this unit should be on. Refer to **Visibility** (*setting the visibility of this unit*) on the previous page.

- 1 Press **M.C.** to display the alphabetical list.
- 2 Turn **M.C.** to select the first letter of the name you are looking for.
 - Press and hold **M.C.** to select the desired character type.
alphabet–Cyrillic alphabet
- 3 Press **M.C.** to display a registered name list.
- 4 Turn **M.C.** to select the name you are looking for.
- 5 Press **M.C.** to display the phone number list.
- 6 Use **M.C.** to select the phone number you want to call.
Turn to change the phone number. Press to select.
- 7 Press **M.C.** to make a call.
- 8 When you find a phone number that you want to store in the memory, press and hold **M.C.** right.

Preset Dial (preset phone numbers)

- 1 Press **M.C.** to display the setting mode.
- 2 Use **M.C.** to select the desired preset number.
Turn to change the menu option. Press to select.
- 3 Press **M.C.** to make a call.

Phone Function (phone function)

You can set **Auto Answer** and **Ring Tone** from this menu. For details, refer to *Function and operation* on this page.

Connection (phone connection)

Operate the Bluetooth telephone connection menu. Refer to *Connection menu operation* on page 25.

Function and operation

1 Display Phone Function.

Refer to **Phone Function** (*phone function*) on this page.

2 Press M.C. to display the function menu.

3 Turn M.C. to select the function.

After selecting, perform the following procedures to set the function.

Auto Answer (automatic answering)

- 1 Press **M.C.** to turn automatic answering on or off.

Ring Tone (ring tone select)

- 1 Press **M.C.** to turn the ring tone on or off.



Audio Adjustments

1 Display the audio menu.

Refer to *Basic menu operations* on page 9.

2 Turn M.C. to select the audio function.

After selecting, perform the following procedures to set the audio function.

Fader/Balance (fader/balance adjustment)

- ① Press **M.C.** to display the setting mode.
- ② Push **M.C.** up or down to adjust the front/rear speaker balance.
Adjustment range (front/rear): **Front 15 to Rear 15**
- ③ Push **M.C.** left or right to adjust the left/right speaker balance.
Adjustment range (left/right): **Left 15 to Right 15**
 - Select **F/R 0** when only using two speakers.
 - When the rear output setting and preout setting are **Subwoofer**, you cannot adjust front/rear speaker balance.

Sonic Center Control (sonic center control)

Sound that is suited for the listening position can easily be created with this function.

- ① Press **M.C.** to display the setting mode.
- ② Push **M.C.** left or right to select a listening position.
Adjustment range: **Left:7 to Right:7**

Auto EQ (auto-equalizer on/off)

The auto-equalizer is an equalizer curve created by auto EQ (refer to *Auto EQ (auto-equalizing)* on page 32).

You can turn the auto-equalizer on or off.

- ① Press **M.C.** to turn the auto-equalizer on or off.
You cannot use this function if auto EQ has not been carried out.

Graphic EQ (equalizer adjustment)

You can adjust the currently selected equalizer curve setting as desired. Adjusted equalizer curve settings are stored in **Custom1** or **Custom2**.

- A separate **Custom1** curve can be created for each source. If you make adjustments when a curve other than **Custom2** is selected, the equalizer curve settings will be stored in **Custom1**.
- A **Custom2** curve that is common for all sources can be created. If you make adjustments when the **Custom2** curve is selected, the **Custom2** curve will be updated.

- ① Press **M.C.** to display the setting mode.
- ② Turn **M.C.** to select an equalizer curve.
Powerful—Natural—Vocal—Custom1—Custom2—Flat—Super Bass
- ③ Push **M.C.** left or right to select the equalizer band to adjust.
40Hz—80Hz—200Hz—400Hz—1kHz—2.5kHz—8kHz—10kHz
- ④ Push **M.C.** up or down to adjust the level of the equalizer band.
Adjustment range: **+12dB to -12dB**

Loudness (loudness)

Loudness compensates for deficiencies in the low- and high-frequency ranges at low volume.

- ① Press **M.C.** to display the setting mode.
- ② Turn **M.C.** to select the desired setting.
Off (off)—Low (low)—Mid (mid)—High (high)
- ③ Press **M.C.** to confirm the selection.

Subwoofer1 (subwoofer on/off setting)

This unit is equipped with a subwoofer output which can be turned on or off.

- ① Press **M.C.** to turn subwoofer output on or off.

Subwoofer2 (subwoofer adjustment)

The cut-off frequency and output level can be adjusted when the subwoofer output is on.

Only frequencies lower than those in the selected range are outputted from the subwoofer.

- ① Press **M.C.** to display the setting mode.
- ② Turn **M.C.** to select the phase of subwoofer output.
Normal (normal phase)—**Reverse** (reverse phase)
- ③ Push **M.C.** up or down to adjust the output level of the subwoofer.
Adjustment range: **+6 to -24**
- ④ Push **M.C.** left or right to select the cut-off frequency.
50Hz—63Hz—80Hz—100Hz—125Hz

Bass Booster (bass boost)

Operating this unit

- 1 Press **M.C.** to display the setting mode.
- 2 Turn **M.C.** to adjust the level.
Adjustment range: **0** to **+6**
- 3 Press **M.C.** to confirm the selection.

High Pass Filter (high pass filter adjustment)

When you do not want low sounds from the subwoofer output frequency range to play from the front or rear speakers, turn on the HPF (high pass filter). Only frequencies higher than those in the selected range are output from the front or rear speakers.

- 1 Press **M.C.** to display the setting mode.
- 2 Turn **M.C.** to select the cut-off frequency.
Off (off)—**50Hz**—**63Hz**—**80Hz**—**100Hz**—**125Hz**
- 3 Press **M.C.** to confirm the selection.

SLA (source level adjustment)

SLA (Source level adjustment) lets you adjust the volume level of each source to prevent radical changes in volume when switching between sources.

- When selecting FM as the source, you cannot switch to **SLA**.
 - Settings are based on the FM volume level, which remains unchanged.
 - The MW/LW volume level can also be adjusted with this function.
- 1 Press **M.C.** to display the setting mode.
 - 2 Push **M.C.** up or down to adjust the source volume.
Adjustment range: **+4** to **-4**

Note

You cannot select **Custom1** and **Custom2** when using the auto-equalizer. 

System settings

1 Display the system menu.

Refer to *Basic menu operations* on page 9.

2 Turn M.C. to select the system function.

After selecting, perform the following procedures to set the system function.

Guide Info (guide information)

- 1 Press **M.C.** to display the guide information.
Refer to *About guide information* on page 11.

Clock ADJ (date and clock)

- 1 Press **M.C.** to display the setting mode.
- 2 Press **M.C.** to select the segment of the clock display you wish to set.
Day—Month—Year—Hour—Minute—AM/PM
- 3 Turn **M.C.** to set the date and time.

Picture ADJ (picture adjustment)

- 1 Press **M.C.** to display the setting mode.
- 2 Turn **M.C.** to select the function to be adjusted.
Press to select.
Brightness—**Contrast**—**Color**—**Hue**—**Dimmer**
—**Temperature**—**Black Level**
For details about the settings, refer to *Changing the picture adjustment* on page 37.
When you select **Black Level**, press **M.C.** to turn the setting on or off.
- 3 Turn **M.C.** to increase or decrease the level of the selected item.
Adjustment range: **+24** to **-24**
 - **Dimmer** can be adjusted from **+48** to **+1**.
 - **Temperature** can be adjusted from **+3** to **-3**.

System Lang. (menu language settings)

- The language can be changed for the following:
 - Function menus
 - System menu
 - Initial menu
 - On-screen display
 - Multi language setting for DivX
- If the embedded language and the selected language setting are not the same, text information may not display properly.
- Some characters may not be displayed properly.
- To complete this operation, switch the ignition key off and on after you set this setting.
 - ① Press **M.C.** to display the setting mode.
 - ② Turn **M.C.** to select the desired language.
English (English)—**Español** (Spanish)—**Português** (Portuguese)—**РУССКИЙ** (Russian)
 - ③ Press **M.C.** to confirm the selection.

Detach Warning (warning tone setting)

If the front panel is not detached from the head unit within four seconds of turning off the ignition, a warning tone sounds. You can turn off the warning tone.

- ① Press **M.C.** to turn warning tone on or off.

AUX Input (auxiliary input)

Activate this setting when using an auxiliary device connected to this unit.

- ① Press **M.C.** to turn **AUX Input** on or off.

Mute/ATT (sound muting/attenuation)

Sound from this system is automatically muted or attenuated when a signal from equipment with a mute function is received.

- Sound from this system returns to normal when the muting or attenuation is canceled.
- ① Press **M.C.** to display the setting mode.
 - ② Turn **M.C.** to select the desired setting.
 - **Mute** – Muting
 - **ATT -20dB** – Attenuation (**ATT -20dB** has a stronger effect than **ATT -10dB**)
 - **ATT -10dB** – Attenuation
 - **Off** – Turns the sound muting/attenuation off
 - ③ Press **M.C.** to confirm the selection.



Entertainment settings

1 Display the entertainment menu.

Refer to *Basic menu operations* on page 9.

2 Turn M.C. to select the entertainment function.

After selecting, perform the following procedures to set the entertainment function.

Background (background display setting)

- ① Press **M.C.** to display the setting mode.
- ② Turn **M.C.** to select the desired setting.
BGP1 (background picture 1)—**BGP2** (background picture 2)—**BGP3** (background picture 3)—**BGV** (background visual)—**Photo** (photo)—**SPEANA** (spectrum analyzer)—**Off** (display off)
- ③ Press **M.C.** to confirm the selection.

Clock (entertainment clock)

- ① Press **M.C.** to turn entertainment clock display on or off.
If the setting is on, it is automatically switched to entertainment clock display.

Slide Show (slide show viewing)

- ① Press **M.C.** to display the setting mode.
- ② Turn **M.C.** to select the external storage device.
USB (USB storage device)—**SD** (SD memory card)
Slideshow will start.

Appearance (screen/illumination color)

- ① Press **M.C.** to display the setting mode.
- ② Turn **M.C.** to change the desired screen/illumination color. Press to select.
Screen (screen color)—**Illumi** (Illumination color)—**Color Setting** (customizing color)
For details on **Color Setting** (customizing color), refer to *Customizing the illumination color* on the next page.
- ③ Turn **M.C.** to change the desired illumination color. Press to select.



The illumination color changes at a regular interval.



The customized color is set as the illumination color.

Operating this unit

Notes

- If **SPEANA** (spectrum analyzer) is selected, the spectrum analyzer will be displayed instead of Source image display or Artwork display.
- If you select **USB, SD** as the source, you cannot select **Slide Show**.

Customizing the illumination color

1 Use M.C. to select Color Setting in the Appearance (Illumination color).

Refer to **Appearance** (*screen/illumination color*) on the previous page.

2 Use M.C. to customize the color.

Turn for fine tuning. Push left or right to adjust the next color.

3 Press M.C. to store the customized color in the memory.

The illumination color will be switched to the customized color. 

Initial Settings

1 Press and hold SRC/OFF until the unit turns off.

2 Press M.C. to display the initial setting menu.

3 Turn M.C. to select the initial setting.

After selecting, perform the following procedures to set the initial setting.

FM step (FM tuning step)

Normally, the FM tuning step employed by seek tuning is 50 kHz. When AF or TA is on, the tuning step automatically changes to 100 kHz. It may be preferable to set the tuning step to 50 kHz when AF is on.

- ① Press **M.C.** to display the setting mode.
- ② Turn **M.C.** to select the FM tuning step.
100kHz (100 kHz)—**50kHz** (50 kHz)
- ③ Press **M.C.** to confirm the selection.

Auto PI (auto PI seek)

The unit can automatically search for a different station with the same programming, even during preset recall.

- ① Press **M.C.** to turn Auto PI seek on or off.

A-EQ Measurement (auto-equalizing)

The auto-equalizer is an equalizer curve created by auto EQ (refer to *Auto EQ (auto-equalizing)* on the next page).

You can turn the auto-equalizer on or off.

Rear Speaker (rear output and subwoofer setting)

Operating this unit

This unit's rear output (rear speaker leads output and RCA rear output) can be used for full-range speaker (**Full**) or subwoofer (**Subwoofer**) connection. If you switch the rear output setting to **Subwoofer**, you can connect a rear speaker lead directly to a subwoofer without using an auxiliary amp. Initially, the unit is set for rear full-range speaker connection (**Full**).

- 1 Press **M.C.** to display the setting mode.
- 2 Turn **M.C.** to change the setting.

Subwoofer (subwoofer)—**Full** (full-range speaker)

 - Even if you change this setting, there will be no output unless you turn the subwoofer output on (refer to **Subwoofer1** (*subwoofer on/off setting*) on page 28).
 - If you change this setting, subwoofer output in the audio menu will return to the factory settings.
- 3 Press **M.C.** to confirm the selection.

Demonstration (demo display setting)

- 1 Press **M.C.** to turn the demo display on or off.

Video Signal (video signal setting)

Be sure to adjust the video signal setting to one that is suitable for your country.

- 1 Press **M.C.** to display the setting mode.
- 2 Turn **M.C.** to select an appropriate video signal.

PAL—NTSC
- 3 Press **M.C.** to confirm the selection.

BT Memory Clear (resetting the Bluetooth wireless technology module)

This function is available only for *MVH-8300BT*. Bluetooth telephone data can be deleted. To protect personal information, we recommend deleting this data before transferring the unit to other persons. The following settings will be deleted.

- phone book entries on the Bluetooth telephone
- preset numbers on the Bluetooth telephone
- registration assignment of the Bluetooth telephone
- call history of the Bluetooth telephone
- information of the connected Bluetooth telephone
- PIN code

- 1 Press **M.C.** to display the setting mode.
- 2 Use **M.C.** to select **Yes**. Turn to change the mode. Press to select. **Cleared** is displayed and the settings are deleted. To cancel, select **No**.
 - While this function is in use, do not turn off the engine.

BT Ver. Info. (Bluetooth version display)

This function is available only for *MVH-8300BT*.

- 1 Press **M.C.** to display the Bluetooth (microprocessor) version of this unit.

Software Update (updating the software)

This function is available only for *MVH-8300BT*.

This function is used to update this unit with the latest software. For information on the software and updating, refer to our website.

- 1 Press **M.C.** to display the setting mode.
- 2 Use **M.C.** to select **Yes** to show a confirmation display. Turn to change the mode. Press to select. To cancel, select **No**. Follow the on-screen instructions to finish updating the software.

Ever Scroll (scroll mode setting)

When ever scroll is set to **On**, recorded text information scrolls continuously in the display. Set to off if you prefer the information to scroll just once.

- 1 Press **M.C.** to turn the ever scroll on or off.

Auto EQ (auto-equalizing)

The auto-equalizer automatically measures the car's interior acoustic characteristics, and then creates an auto-equalizer curve based on that information.

- To perform this function, dedicated microphone (e.g. CD-MC20) is required.

WARNING

As a loud tone (noise) may be emitted from the speakers when measuring the car's interior acoustic characteristics, never perform auto EQ while driving.

CAUTION

- Thoroughly check the conditions before performing auto EQ as the speakers may be damaged if these functions are performed when:
 - The speakers are incorrectly connected. (For example, when a rear speaker is connected as a subwoofer output.)

Operating this unit

- A speaker is connected to a power amp delivering output higher than the speaker's maximum input power capability.
- If the microphone is placed in an unsuitable position the measurement tone may become loud and measurement may take a long time, resulting in battery drainage. Be sure to place the microphone in the specified location.

Before operating the auto EQ function

- Carry out auto EQ in as quiet a place as possible, with the car engine and air conditioning switched off. Also cut power to car phones or portable telephones in the car, or remove them from the car before carrying out auto EQ. Sounds other than the measurement tone (surrounding sounds, engine sound, telephones ringing etc.) may prevent correct measurement of the car interior acoustic characteristics.
- Be sure to carry out auto EQ using the optional microphone. Using another microphone may prevent measurement, or result in incorrect measurement of the car interior acoustic characteristics.
- In order to perform auto EQ, the front speaker must be connected.
- When this unit is connected to a power amp with input level control, auto EQ may not be possible if the power amp's input level is set below the standard level.
- When this unit is connected to a power amp with an LPF, turn this LPF off before performing auto EQ. Also set the cut-off frequency for the built-in LPF of an active subwoofer to the highest frequency.
- The distance has been calculated by computer to be the optimum delay to give accurate results for the circumstances, so please continue to use this value.
 - The reflected sound within the car is strong and delays occur.
 - The LPF on active subwoofers or external amps delay the lower sounds.
- Auto EQ changes the audio settings as follows:

- The fader/balance settings return to the center position. (Refer to **Fader/Balance** (*fader/balance adjustment*) on page 28.)
- The equalizer curve switches to **Flat**. (Refer to **Graphic EQ** (*equalizer adjustment*) on page 28.)
- The front, center and rear speakers will automatically be adjusted to a high pass filter setting.
- Previous settings for auto EQ will be overwritten.

Performing auto EQ

1 Stop the car in a place that is quiet, close all the doors, windows and sun roof, and then turn the engine off.

If the engine is left running, engine noise may prevent correct auto EQ.

2 Fix the optional microphone in the center of the headrest of the driver's seat, facing forward.

The auto EQ may differ depending on where you place the microphone. If desired, place the microphone on the front passenger seat to carry out auto EQ.

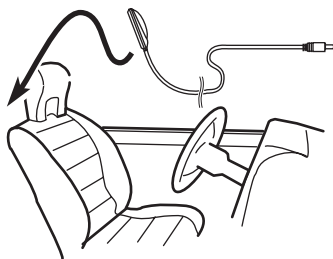

3 Turn the ignition switch to ON or ACC.

If the car's air conditioner or heater is turned on, turn it off. Noise from the fan in the air conditioner or heater may prevent correct auto EQ.

- If this unit is turned off, press **SRC/OFF** to turn the source on.

4 Display the initial setting menu.

Refer to *Initial Settings* on page 31.

Operating this unit

5 Use M.C. to enter the auto EQ measurement mode.

Turn to change the menu option. Press to select.

6 Plug the microphone into the microphone input jack on this unit.

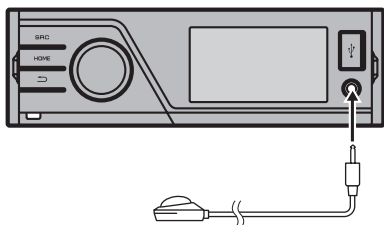

7 Press M.C. to start auto EQ.

8 When the 10-second countdown starts, get out of the car and close the door within 10 seconds.

A measurement tone (noise) is emitted from the speakers, and auto EQ measurement begins.

- It takes about nine minutes for auto EQ measurement to be completed when all the speakers are connected.
- To stop auto EQ, press **M.C.**

9 When auto EQ is completed, Complete is displayed.

When the car's interior acoustic characteristics cannot be measured correctly, an error message will be displayed. (Refer to *Understanding auto EQ error messages* on page 40.)

10 Store the microphone carefully in the glove compartment or another safe place.

If the microphone is subjected to direct sunlight for an extended period, high temperatures may cause distortion, color change or malfunction. ■

Other functions

Using an AUX source

When connecting auxiliary device using the front AUX input.

- You need to activate the AUX setting in the initial setting menu. Refer to **AUX Input (auxiliary input)** on page 30.
- If an iPod with video capabilities is connected to this unit via 3.5 mm plug (4 pole) cable (such as the CD-V150M), you can enjoy the video contents of the connected iPod.
- A portable audio/video player can be connected by using a 3.5 mm plug (4 pole) with an RCA cable (sold separately). However, depending on the cable, a reverse connection between the red (right side audio) cable and yellow (video) cable may be required in order for the sound and video image to be reproduced correctly.

● Insert the mini plug into the AUX input jack on this unit.

For more details, refer to *Head unit* on page 8. This auxiliary device is automatically set to **AUX**.

Function settings

1 Press M.C. to display the function menu.

2 Turn M.C. to select the function.

After selecting, perform the following procedures to set the function.

A/V Change (auxiliary device signal setting)

- 1 Press **M.C.** to display the setting mode.
- 2 Turn **M.C.** to select the desired setting.
 - **Audio** – auxiliary device connected with a stereo mini plug cable
 - **Video** – auxiliary video device connected with 4-pole mini plug cable (e.g., CD-V150M)
- 3 Press **M.C.** to confirm the selection.

Display (display setting)

Operating this unit

You can switch to the basic screen or the image screen.

- ① Press **M.C.** to display the setting mode.
- ② Press **M.C.** to select the desired setting.

Wide Mode (switching the wide mode)



- ① Press **M.C.** to display the setting mode.
- ② Turn **M.C.** to select the desired setting.
Full (full)—**Just** (just)—**Cinema** (cinema)—**Zoom** (zoom)—**Normal** (normal)
 For details about the settings, refer to *Changing the wide screen mode* on the next page.
- ③ Press **M.C.** to confirm the selection.

Notes

- You can select **Display** and **Wide Mode**, when **Video** has been selected.
- You can select the following functions if the background setting on the entertainment menu is off.
 - **Wide Mode** (switching the wide mode)
 - **Display** (display setting)

Switching the display indication

Display indication can be switched on or off.

- **Press and hold** .
- Pressing one of the buttons will turn on display indication. .

Changing the wide screen mode

You can select a desired mode for enlarging a 4:3 picture to a 16:9 picture.

● Display the screen mode.

Refer to **Wide Mode** (*switching the wide mode*) on page 17.

Full (full screen)

The 4:3 picture is enlarged in the horizontal direction only, giving you a 4:3 TV picture (normal picture) without any omissions.

Just (just)

The picture is enlarged slightly at the center and the amount of enlargement increases horizontally toward the edges of the screen, enabling you to enjoy a 4:3 picture without sensing any disparity even when viewing on a wide screen.

Cinema (cinema)

The picture is enlarged by the same proportion as **Full** or **Zoom** in the horizontal direction and by an intermediate proportion between **Full** and **Zoom** in the vertical direction; ideal for a cinema-sized picture (wide screen picture) where captions lie outside the picture.

Zoom (zoom)

The 4:3 picture is enlarged in the same proportion both vertically and horizontally; ideal for a cinema sized picture (wide screen picture).

Normal (normal)

The 4:3 picture is displayed as it is, giving you no sense of disparity since its proportions are the same as that of the normal picture.

Notes

- Different settings can be stored for each video source.
- When a video is viewed in a wide screen mode that does not match its original aspect ratio, it may appear different.
- Remember that using the wide mode feature of this system for commercial or public viewing purposes may constitute an infringement on the author's rights protected by the Copyright Law.
- The video image will appear coarser when viewed in **Cinema** or **Zoom** mode.

Setting the DivX subtitle file

You can select whether or not to display DivX external subtitles.

- The DivX subtitles will be displayed even when **Custom** is selected if no DivX external subtitle files exist.
- You can select the following functions if the background setting on the entertainment menu is off.

● Display the DivX subtitle file setting mode.

Refer to **DivX® Subtitle** (*DivX subtitle file settings*) on page 17.

- **Original** – Display the DivX subtitles
- **Custom** – Display the DivX external subtitles

Notes

- Up to 42 characters can be displayed on one line. If more than 42 characters are set, the line breaks and the characters are displayed on the next line.
- Up to 126 characters can be displayed on one screen. If more than 126 characters are set, the excess characters will not be displayed.

Setting the aspect ratio

● Display the aspect ratio setting mode.

Refer to **TV Aspect** (*aspect ratio settings*) on page 17.

- **16:9** – Wide screen picture (16:9) is displayed as is (initial setting)
- **Letter Box** – The picture is the shape of a letterbox with black bands on the top and bottom of the screen
- **Pan Scan** – The picture is cut short on the right and left sides of the screen

Displaying the DivX® VOD registration code

In order to play DivX VOD (video on demand) contents on this unit, the unit must first be registered with a DivX VOD contents provider. For registration, generate a DivX VOD registration code and submit it to your provider.

Detailed instructions

- Keep a record of the code as you will need it when you register your unit to the DivX VOD provider.
- **Select Registration.**
Refer to **DivX® VOD** (*DivX® VOD registration code*) on page 17.
Your registration code is displayed.
- **Dimmer** – Adjusts the brightness of the display
- **Temperature** – Adjusts the color temperature, resulting in a better white balance
- **Black Level** – Emphasizes the dark portions of images making the difference between bright and dark more distinct

Displaying the deregistration code

If your device is already registered, deregister it by entering the deregistration code.

1 Select Deregistration.

Refer to **DivX® VOD** (*DivX® VOD registration code*) on page 17.

2 Use M.C. to select Yes.

Turn to change the menu option. Press to select.

The deregistration is completed.

- To cancel deregistration, select **No**.

Changing the picture adjustment

You can adjust the **Brightness** (brightness), **Contrast** (contrast), **Color** (color), **Hue** (hue), **Dimmer** (dimmer), **Temperature** (temperature) and **Black Level** (black level) for each source.

- You cannot adjust **Color**, **Hue** and **Black Level** for the audio source.
- If the color system is not NTSC, you cannot adjust **Hue**.
- If the color system is set to PAL, you cannot adjust **Hue**.
Refer to **Video Signal** (*video signal setting*) on page 32.

● Display the picture adjustment mode.

Refer to **Picture ADJ** (*picture adjustment*) on page 29.

- **Brightness** – Adjusts the black intensity
- **Contrast** – Adjusts the contrast
- **Color** – Adjusts the color saturation
- **Hue** – Adjusts the tone of color (red or green is emphasized)

Additional information

Troubleshooting

Common

Symptom	Cause	Action
The power will not turn on. The unit will not operate.	Leads and connectors are incorrectly connected. The fuse is blown.	Confirm once more that all connections are correct. Rectify the cause and then replace the fuse. Be sure to install a fuse with the same rating.
	Noise and/or other factors are causing the built-in microprocessor to operate incorrectly.	Press RESET .
Operation with the remote control is not possible. The unit does not operate correctly even when the appropriate remote control buttons are pressed.	Battery power is low.	Load a new battery.
There is no sound. The volume level will not rise.	Cables are not connected correctly.	Connect the cables correctly.
The aspect ratio is incorrect and the image is stretched.	The aspect ratio setting is incorrect for the display.	Select the appropriate setting for your display.
There is no image displayed.	The parking brake cable is not connected. The parking brake is not applied.	Connect the parking brake cable, and apply the parking brake. Connect the parking brake cable, and apply the parking brake.
The image displayed stops (pauses) and the unit cannot be operated.	The data could no longer be read during playback.	Stop playback once, and start playback again.

Symptom	Cause	Action
There is no sound.	The volume level is low.	Adjust the volume level.
The volume level is low.	The attenuator is on.	Turn the attenuator off.
The sound and video skip.	The unit is not firmly secured.	Firmly secure the unit.
NO XXXX appears when a display is changed (NO TITLE , for example).	There is no embedded text information.	Switch the display or play another track/file.
Sub-folders cannot be played back.	Folder repeat play has been selected.	Select the repeat range again.
The repeat range changes automatically.	Another folder was selected during repeat play. Track search or fast forward/reverse was performed during file repeat play.	Select the repeat range again. Select the repeat range again.

Problems during iPod playback

Symptom	Cause	Action
The iPod does not operate correctly.	The cables are incorrectly connected. The iPod version is old.	Disconnect the cable from the iPod. Once the iPod's main menu is displayed, reconnect the iPod and reset it. Update the iPod version.



Error messages

When you contact your dealer or your nearest Pioneer Service Center, be sure to note the error message.

External storage device (USB, SD)

Message	Cause	Action
No Device	The USB storage device is not connected.	Connect a compatible USB storage device.

Additional information

Message	Cause	Action
Unplayable File	This type of file cannot be played on this unit.	Select a file that can be played.
	There are no songs.	Transfer the audio files to the external storage device and connect.
	The connected USB storage device has security enabled.	Follow the USB memory instructions to disable security.
Format Read	Sometimes there is a delay between the start of playback and when you start to hear any sound.	Wait until the message disappears and you hear sound.
Skipped	The external storage device in use contains WMA files embedded with Windows Media™ DRM 9/10.	Play an audio file not embedded with Windows Media DRM 9/10.
Protect	All the files in the external storage device are embedded with Windows Media DRM 9/10.	Transfer audio files not embedded with Windows Media DRM 9/10 to the external storage device and connect.
Incompatible USB	The USB device connected to is not supported by this unit.	Connect a USB Mass Storage Class compliant device.
	The USB device is not formatted with FAT16 or FAT32.	The connected USB device should be formatted with FAT16 or FAT32.
Incompatible SD	Non-compatible SD storage device	Remove your device and replace it with a compatible SD storage device.

Message	Cause	Action
Check USB	The USB connector or USB cable has short-circuited.	Check that the USB connector or USB cable is not caught in something or damaged.
	The connected USB portable audio player/USB memory consumes more than maximum allowable current.	Disconnect the USB storage device and do not use it. Turn the ignition switch to OFF, then to ACC or ON and then connect only compliant USB storage devices.
Error-02-9X/-DX	Communication failed.	Perform one of the following operations. –Turn the ignition switch OFF and back ON. –Disconnect or eject the external storage device. –Change to a different source. Then, return to the USB or SD source.
Rental expired.	The connected external storage device contains expired DivX VOD content.	<ul style="list-style-type: none"> • Replace the external storage device. • Select a file that can be played.
File Not Playable-High Definition	The connected external storage device contains a high definition DivX file.	<ul style="list-style-type: none"> • This unit cannot play DivX HD files. Replace the external storage device with one this unit can play. • Select a file that can be played.
It is not possible to write it in the flash.	This unit's flash memory used as the temporary storage area is full.	Select a file that can be played.
Authorization Error	This unit's DivX registration code has not been authorized by the DivX VOD contents provider.	Register this unit to the DivX VOD contents provider.

Additional information

Message	Cause	Action
Video frame rate not supported	The external storage device's frame rate is more than 30 fps.	Replace the external storage device.
Audio Format not supported	This type of file is not supported on this unit.	Select a file that can be played.
Not Found	No related files	Transfer a file that can be played.

iPod

Message	Cause	Action
No Device	USB storage device or iPod is not connected.	Connect a compatible iPod.
Incompatible USB	Non-compatible iPod	Disconnect your device and replace it with a compatible iPod.
Check USB	The iPod operates correctly but does not charge.	Make sure the connection cable for the iPod has not shorted out (e.g., not caught in metal objects). After checking, turn the ignition switch OFF and back ON, or disconnect the iPod and reconnect.
Format Read/Ready	Sometimes there is a delay between the start of playback and when you start to hear any sound.	Wait until the message disappears and you hear sound.

Error-02-6X/-9X/-DX	Communication failed.	Disconnect the cable from the iPod. Once the iPod's main menu is displayed, reconnect the iPod and reset it.
	iPod failure.	Disconnect the cable from the iPod. Once the iPod's main menu is displayed, reconnect the iPod and reset it.

Message	Cause	Action
Error-02-67	The iPod firmware version is old.	Update the iPod version.
Stop	There are no songs.	Transfer songs to the iPod.
	There are no songs in the current list.	Select a list that contains songs.
No xxxx	There is no information.	Record information on the iPod.
Not Found	No related songs.	Transfer songs to the iPod.

Bluetooth Telephone

Message	Cause	Action
Error-10	The power failed for the Bluetooth module of this unit.	Turn the ignition switch OFF and then to ACC or ON. If the error message is still displayed after performing the above action, please contact your dealer or an authorized Pioneer Service Station.



Understanding auto EQ error messages

When correct measurement of the car's interior acoustic characteristics is not possible using auto EQ, an error message may appear on the display. In such cases, refer to the table below to see what the problem is and how it may be corrected. After checking, try again.

Message	Cause	Action
Error. Please check MIC.	The microphone is not connected.	Plug the optional microphone securely into the jack.





Additional information

Message	Cause	Action
Error. Please check xxxx speaker.	The microphone cannot pick up the measuring tone of a speaker.	<ul style="list-style-type: none"> • Confirm that the speakers are connected correctly. • Correct the input level setting of the power amp connected to the speakers. • Set the microphone correctly.
Error. Please check noise.	The surrounding noise level is too high.	<ul style="list-style-type: none"> • Stop your car in a place that is quiet, and switch off the engine, air conditioner and heater. • Set the microphone correctly.
Error. Please check battery.	Power is not being supplied from the battery to this unit.	<ul style="list-style-type: none"> • Stop your car in a place that is quiet, and switch off the engine, air conditioner and heater. • Connect the battery correctly.





Indicator list



Common

	(MVH-8300BT only) Indicates that a Bluetooth telephone is connected.
	(MVH-8300BT only) Indicates the signal strength of the cellular phone.
A-EQ	Indicates that Auto EQ is on.
	Indicates that TA (traffic announcement standby) is on.
	Indicates that a set news program has been received.

iPod

	Shows when repeat play is set to One or All .
	Shows when shuffle function is on.
S.Rtrv	Shows when the sound retriever function is on.

External storage device (USB, SD)

	Shows when the repeat range is selected for the current file.
	Shows when the repeat range is selected for the current folder.
	Shows when random play is on.
S.Rtrv	Shows when the sound retriever function is on.

Tuner

Local	Shows when local seek tuning is on.
	Indicates that the selected frequency is being broadcast in stereo.
Text	Indicates that a radio text has been received.



Additional information

Handling guidelines

External storage device (USB, SD)

Address any questions you have about your external storage device (USB, SD) to the manufacturer of the device.

Do not leave the external storage device (USB, SD) in places with high temperatures.

Depending on the external storage device (USB, SD), the following problems may occur.

- Operations may vary.
- The storage device may not be recognized.
- Files may not be played back properly.

USB storage device

Connections via USB hub are not supported.

Do not connect anything other than a USB storage device.

Firmly secure the USB storage device when driving. Do not let the USB storage device fall onto the floor, where it may become jammed under the brake or accelerator pedal.

Depending on the USB storage device, the device may cause noise to occur in the radio.

- The device may generate noise in the radio.

This unit can play back files in the USB portable audio player/USB memory that is USB Mass Storage Class. However, copyright protected files that are stored in the USB devices cannot be played back.

You cannot connect a USB portable audio player/USB memory to this unit via USB hub.

Partitioned USB memory is not compatible with this unit.

Depending on the kind of USB portable audio player/USB memory you use, the device may not be recognized or audio files may not be played back properly.

Do not leave the USB portable audio player/USB memory in direct sunlight for extended amounts of time. Doing so may cause the device to malfunction from the extreme rise in temperature.

SD memory card

This unit supports only the following types of SD memory cards.

- SD
- SDHC

Keep the SD memory card out of the reach of children. Should the SD memory card be swallowed, consult a doctor immediately.

Do not touch the connectors of the SD memory card directly with your fingers or with any metal device.

Do not insert anything other than an SD memory card into the SD card slot. If a metal object (such as a coin) is inserted into the slot, the internal circuits may break and cause malfunctions.

Do not insert a damaged SD memory card (e.g. warped, label peeled off) as it may not be ejected from the slot.

Do not try to force an SD memory card into the SD card slot as the card or this unit may be damaged.

When ejecting an SD memory card, press it and hold it until it clicks. It is dangerous for you to release your finger immediately after you press on the card as the card may shoot out of the slot and hit you in the face, etc. If the card shoots out of the slot, it may become lost.

iPod

Do not leave the iPod in direct sunlight for extended amounts of time. Doing so may cause the iPod to malfunction due to an extreme rise in temperature.

Do not leave the iPod in places with high temperatures.

To ensure proper operation, connect the dock connector cable from the iPod directly to this unit.

Firmly secure the iPod when driving. Do not let the iPod fall onto the floor, where it may become jammed under the brake or accelerator pedal.

For details, refer to the manuals for the iPod.

About iPod settings

- When an iPod is connected, this unit changes the EQ (equalizer) setting of the iPod to off in order to optimize the acoustics. When you disconnect the iPod, the EQ returns to the original setting.
- You cannot set Repeat to off on the iPod when using this unit. Repeat is automatically changed to All when the iPod is connected to this unit.

Additional information

JPEG picture files

JPEG is short for Joint Photographic Experts Group and refers to a still image compression technology standard.

Files are compatible with Baseline JPEG and EXIF 2.1 still images up to a resolution of 8 192 × 7 680. (EXIF format is used most commonly with digital still cameras.)

Playback of EXIF format files that were processed by a personal computer may not be possible.

There is no progressive JPEG compatibility.

DivX video files

Depending on the composition of the file information, such as the number of audio streams or file size, there may be a slight delay in playback if data is being played back from an external storage device.

Some special operations may be prohibited due to the composition of the DivX files.

Only DivX files downloaded from a DivX partner site are guarantee for proper operation. Unauthorized DivX files may not operate properly.

DRM rental files cannot be operated until playback is started.

Recommended file size: 2 Mbps or less with a transmission rate of 2 GB or less.

The ID code of this unit must be registered to a DivX VOD provider in order to playback DivX VOD files. For information on ID codes, refer to *Displaying the DivX® VOD registration code* on page 36.

For more details about DivX, visit the following site: <http://www.divx.com/>

Important

- When naming a JPEG image file, add the corresponding filename extension (.jpg, .jpeg, .jpe or .jfif).
- This unit plays back files with these filename extensions (.jpg, .jpeg, .jpe or .jfif) as a JPEG image file. To prevent malfunctions, do not use these extensions for files other than JPEG image files. 

Compressed audio/video compatibility (USB, SD)

WMA

File extension: .wma

Bit rate: 5 kbps to 320 kbps (CBR), VBR

Sampling frequency: 8 kHz to 48 kHz

Windows Media Audio Professional, Lossless, Voice/DRM Stream/Stream with video: Not compatible

MP3

File extension: .mp3

Bit rate: 8 kbps to 320 kbps (CBR), VBR

Sampling frequency: 8 kHz to 48 kHz (32 kHz, 44.1 kHz, 48 kHz for emphasis)

Compatible ID3 tag version: 1.0, 1.1, 2.2, 2.3 (ID3 tag Version 2.x is given priority than Version 1.x.)

M3u playlist: Not compatible

MP3i (MP3 interactive), mp3 PRO: Not compatible

AAC

Compatible format: AAC encoded by iTunes

File extension: .m4a

Bit rate: 8 kbps to 320 kbps

Sampling frequency: 8 kHz to 44.1 kHz

Apple Lossless: Not compatible

AAC file bought from the iTunes Store (.m4p file extension): Not compatible

DivX compatibility

Compatible format: DivX video format implemented in relation to DivX standards

File extensions: .avi or .divx

DivX Ultra format: Not compatible

DivX HD format: Not compatible

DivX files without video data: Not compatible

Compatible audio codec: MP2, MP3, Dolby Digital

LPCM: Not compatible

Additional information

Bit rate: 8 kbps to 320 kbps (CBR), VBR

Sampling frequency: 32 kHz, 44.1 kHz, 48 kHz

Compatible external subtitle file extension: .srt

Supplemental information

Only the first 32 characters can be displayed as a file name (including the file extension) or a folder name.

This unit may not operate correctly depending on the application used to encode WMA files.

There may be a slight delay when starting playback of audio files embedded with image data.

Russian text to be displayed on this unit should be encoded in one of the following character sets:

- Unicode (UTF-8, UTF-16)
- A character set other than Unicode that is used in a Windows environment and is set to Russian in the multi-language setting

External storage device (USB, SD)

Playable folder hierarchy: up to eight tiers (A practical hierarchy is less than two tiers).

Playable folders: up to 6 000

Playable files: up to 65 535

Playback of copyright-protected files: Not compatible

Partitioned external storage device (USB, SD): Only the first playable partition can be played.

There may be a slight delay when starting playback of audio files on an external storage device (USB, SD) with numerous folder hierarchies.

SD memory card

There is no compatibility for Multi Media Cards (MMC).

Compatibility with all SD memory cards is not guaranteed.

This unit is not compatible with SD-Audio/SD-Video.

CAUTION

Pioneer accepts no responsibility for data lost on the USB memory/USB portable audio player/SD

memory card even if that data is lost while using this unit. 

iPod compatibility

This unit supports only the following iPod models. Supported iPod software versions are shown below. Older versions may not be supported.

- iPhone 4 (software version 4.1)
- iPhone 3GS (software version 4.1)
- iPhone 3G (software version 4.1)
- iPhone (software version 3.1.3)
- iPod nano 6th generation (software version 1.0)
- iPod nano 5th generation (software version 1.0.2)
- iPod nano 4th generation (software version 1.0.4)
- iPod nano 3rd generation (software version 1.1.3)
- iPod nano 2nd generation (software version 1.1.3)
- iPod nano 1st generation (software version 1.3.1)
- iPod touch 4th generation (software version 4.1)
- iPod touch 3rd generation (software version 4.0)
- iPod touch 2nd generation (software version 4.0)
- iPod touch 1st generation (software version 3.1.3)
- iPod classic 160GB (software version 2.0.4)
- iPod classic 120GB (software version 2.0.1)
- iPod classic (software version 1.1.2)
- iPod 5th generation (software version 1.3)

Depending on the generation or version of the iPod, some functions may not be available.

Operations may vary depending on the software version of iPod.

When using an iPod, an iPod Dock Connector to USB Cable is required.

A Pioneer CD-IU50 interface cable is also available. For details, consult your dealer.

About the file/format compatibility, refer to the iPod manuals.

Audio Book, Podcast: Compatible

CAUTION

Pioneer accepts no responsibility for data lost on the iPod, even if that data is lost while this unit is used. 

Additional information

Sequence of audio files

The user cannot assign folder numbers and specify playback sequences with this unit.

Example of a hierarchy

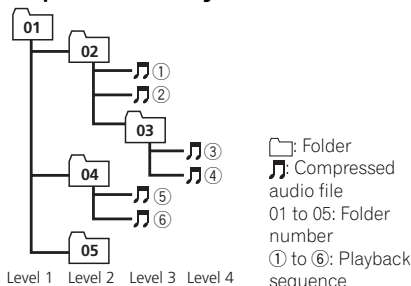

External storage device (USB, SD)

The playback sequence is the same as the recorded sequence in the external storage device (USB, SD).

To specify the playback sequence, the following method is recommended.

- ① Create a file name that includes numbers that specify the playback sequence (e.g., 01xxx.mp3 and 099yyy.mp3).
- ② Put those files into a folder.
- ③ Save the folder that contains the files to the external storage device (USB, SD).

However, depending on the system environment, you may not be able to specify the playback sequence.

For USB portable audio players, the sequence is different and depends on the player.

Using the display correctly

CAUTION

- If liquid or foreign matter should get inside this unit, turn off the power immediately and consult your dealer or the nearest authorized PIONEER Service Station. Do not use the unit in this condition because doing so may result in fire, electric shock, or other failure.
- If you notice smoke, a strange noise or smell, or any other abnormal signs from the display,

turn off the power immediately and consult your dealer or the nearest authorized PIONEER Service Station. Using this unit in this condition may result in permanent damage to the system.

- Do not disassemble or modify this unit, as there are high-voltage components inside which may cause electric shock. Be sure to consult your dealer or the nearest authorized PIONEER Service Station for internal inspection, adjustments, or repairs.

Handling the display

- When the display is subjected to direct sunlight for a long period of time, it will become very hot resulting in possible damage to the LCD screen. You should avoid exposing the display unit to direct sunlight as much as possible.
- The display should be used within the temperature range of -10°C to $+60^{\circ}\text{C}$. At temperatures higher or lower than this operating temperature range, the display may not operate normally.

Liquid crystal display (LCD) screen

- Heat from the heater may damage the LCD screen, and cool air from the cooler may cause moisture to form inside the display resulting in possible damage. Also, if the display is cooled down by the cooler, the screen may become dark, or the life span of the small fluorescent tube used inside the display may be shortened.
- Small black dots or white dots (bright dots) may appear on the LCD screen. These are due to the characteristics of the LCD screen and do not indicate a malfunction.
- When using a cellular phone, keep the antenna away from the display to prevent disruption of the video image by the appearance of spots, colored stripes, etc.

Additional information

LED (light-emitting diode) backlight

- At low temperatures, using the LED backlight may increase image lag and degrade the image quality due to the characteristics of the LCD screen. Image quality will improve with an increase in temperature.
- To protect the LED backlight, the display will darken in the following environments:
 - In the direct sunlight
 - Near the heater vent
- The product lifetime of the LED backlight is more than 10 000 hours. However, it may decrease if used in high temperatures.
- If the LED backlight reaches the end of its product lifetime, the screen will become dark and the image will no longer be projected. In such cases, please consult your dealer or the nearest authorized PIONEER Service Station.

Fluorescent tube

- A small fluorescent tube is used inside the display to illuminate the LCD screen.
 - The fluorescent tube should last for approximately 10 000 hours, depending on operating conditions. (Using the display at low temperatures reduces the service life of the fluorescent tube.)
 - When the fluorescent tube reaches the end of its useful life, the screen will be dark and the image will no longer be projected. If this happens, consult your dealer or the nearest authorized PIONEER Service Station. 

Copyright and trademark

This item incorporates copy protection technology that is protected by U.S. patents and other intellectual property rights of Rovi Corporation. Reverse engineering and disassembly are prohibited.

Bluetooth

The Bluetooth® word mark and logos are registered trademarks owned by Bluetooth SIG, Inc. and any use of such marks by Pioneer Corporation is under license. Other trademarks and trade names are those of their respective owners.

iTunes

Apple and iTunes are trademarks of Apple Inc., registered in the U.S. and other countries.

MP3

Supply of this product only conveys a license for private, non-commercial use and does not convey a license nor imply any right to use this product in any commercial (i.e. revenue-generating) real time broadcasting (terrestrial, satellite, cable and/or any other media), broadcasting/streaming via internet, intranets and/or other networks or in other electronic content distribution systems, such as pay-audio or audio-on-demand applications. An independent license for such use is required. For details, please visit <http://www.mp3licensing.com>.

WMA

Windows Media is either a registered trademark or trademark of Microsoft Corporation in the United States and/or other countries. This product includes technology owned by Microsoft Corporation and cannot be used or distributed without a license from Microsoft Licensing, Inc.

SD memory card

SD Logo is a trademark of SD-3C, LLC. SDHC Logo is a trademark of SD-3C, LLC.

iPod & iPhone

iPhone, iPod, iPod classic, iPod nano, and iPod touch are trademarks of Apple Inc., registered in the U.S. and other countries.

Additional information

“Made for iPod” and “Made for iPhone” mean that an electronic accessory has been designed to connect specifically to iPod or iPhone, respectively, and has been certified by the developer to meet Apple performance standards.

Apple is not responsible for the operation of this device or its compliance with safety and regulatory standards.

Please note that the use of this accessory with iPod or iPhone may affect wireless performance.

DivX

DivX® is a registered trademark of DivX, Inc., and is used under license.

ABOUT DIVX VIDEO: DivX® is a digital video format created by DivX, Inc. This is an official DivX Certified® device that plays DivX video. Visit divx.com for more information and software tools to convert your files into DivX video.

ABOUT DIVX VIDEO-ON-DEMAND: This DivX Certified® device must be registered in order to play purchased DivX Video-on-Demand (VOD) movies. To obtain your registration code, locate the DivX VOD section in *Playing moving images*. Go to vod.divx.com for more information on how to complete your registration.

Dolby Digital

Manufactured under license from Dolby Laboratories. “Dolby” and the double-D symbol are trademarks of Dolby Laboratories. 

Specifications

General

Rated power source	14.4 V DC (allowable voltage range: 10.8 V to 15.1 V DC)
Grounding system	Negative type
Maximum current consumption	10.0 A
Dimensions (W × H × D):	
DIN	
Chassis	178 mm × 50 mm × 162 mm
Nose	188 mm × 58 mm × 17 mm
D	
Chassis	178 mm × 50 mm × 162 mm
Nose	188 mm × 58 mm × 17 mm
Weight	1.1 g (MVH-8300BT)
Weight	1.0 g (MVH-7300)

Display

Screen size/aspect ratio	3.0 inch wide/16:9 (effective display area: 66.8 mm × 36.7 mm)
Pixels	345 600 (1 440 × 240)
Display method	TFT active matrix
Color system	PAL/SECAM compatible
Durable temperature range (power off)	-20 °C to +80 °C

Audio

Maximum power output	50 W × 4 70 W × 1/2 Ω (for subwoofer)
Continuous power output	22 W × 4 (50 Hz to 15 000 Hz, 5% THD, 4 Ω load, both channels driven)
Load impedance	4 Ω (4 Ω to 8 Ω (2 Ω for 1 ch) allowable)
Preout maximum output level	4.0 V
Equalizer (8-Band Graphic Equalizer):	
Frequency	40 Hz/80 Hz/200 Hz/400 Hz/ 1 kHz/2.5 kHz/8 kHz/10 kHz
Gain	±12 dB
High pass filter:	
Frequency	50 Hz/63 Hz/80 Hz/100 Hz/ 125 Hz
Slope	-12 dB/oct

Additional information

Subwoofer (mono):

Frequency	50 Hz/63 Hz/80 Hz/100 Hz/ 125 Hz
Slope	-18 dB/oct
Gain	+6 dB to -24 dB
Phase	Normal/Reverse

Bass boost:

Gain	+12 dB to 0 dB
------------	----------------

USB

USB standard specification

.....	USB 1.1, USB 2.0 full speed
Maximum current supply	500 mA
USB Class	MSC (Mass Storage Class)
File system	FAT16, FAT32
MP3 decoding format	MPEG-1 & 2 Audio Layer 3
WMA decoding format	Ver. 7, 7.1, 8, 9, 10, 11, 12 (2 ch audio) (Windows Media Player)
AAC decoding format	MPEG-4 AAC (iTunes en- coded only) (Ver. 9.0.3 and earlier)
DivX decoding format	Home Theater Ver. 3, 4, 5.2, 6 (.avi, .divx)

SD

Compatible physical format

.....	Version 1.10
File system	FAT12, FAT16, FAT32
MP3 decoding format	MPEG-1 & 2 Audio Layer 3
WMA decoding format	Ver. 7, 7.1, 8, 9, 10, 11, 12 (2 ch audio) (Windows Media Player)
AAC decoding format	MPEG-4 AAC (iTunes en- coded only) (Ver. 9.0.3 and earlier)
DivX decoding format	Home Theater Ver. 3, 4, 5.2, 6 (.avi, .divx)

FM tuner

Frequency range	87.5 MHz to 108.0 MHz
Usable sensitivity	9 dBf (0.8 μ V/75 Ω mono, S/N: 30 dB)
Signal-to-noise ratio	72 dB (IEC-A network)

MW tuner

Frequency range	531 kHz to 1 602 kHz (9 kHz)
Usable sensitivity	25 μ V (S/N: 20 dB)
Signal-to-noise ratio	62 dB (IEC-A network)

LW tuner

Frequency range	153 kHz to 281 kHz
Usable sensitivity	28 μ V (S/N: 20 dB)
Signal-to-noise ratio	62 dB (IEC-A network)

Bluetooth

(MVH-8300BT)

Version	Bluetooth 2.0 certified
Output power	+4 dBm Maximum (Power class 2)

Note

Specifications and the design are subject to modifications without notice. 

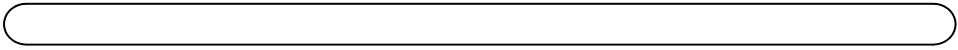

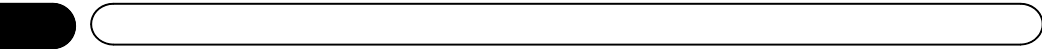

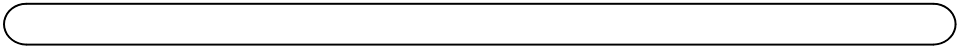

<http://www.pioneer.eu>

Visit www.pioneer.co.uk (or www.pioneer.eu) to register your product.

PIONEER CORPORATION

28-8, Honkomagome 2-chome, Bunkyo-ku,
Tokyo 113-0021, JAPAN

PIONEER ELECTRONICS (USA) INC.

P.O. Box 1540, Long Beach, California 90801-1540, U.S.A.
TEL: (800) 421-1404

PIONEER EUROPE NV

Haven 1087, Keetberglaan 1, B-9120 Melsele, Belgium/Belgique
TEL: (0) 3/570.05.11

PIONEER ELECTRONICS ASIACENTRE PTE. LTD.

2 Jalan Kilang Barat, #07-01, Singapore 159346
TEL: 65-6378-7888

PIONEER ELECTRONICS AUSTRALIA PTY. LTD.

5 Arco Lane, Heatherton, Victoria, 3202 Australia
TEL: (03) 9586-6300

PIONEER ELECTRONICS OF CANADA, INC.

300 Allstate Parkway, Markham, Ontario L3R 0P2, Canada
TEL: 1-877-283-5901
TEL: 905-479-4411

PIONEER ELECTRONICS DE MÉXICO S.A. de C.V.

Blvd.Manuel Ávila Camacho 138, 10 piso
Col.Lomas de Chapultepec, México, D.F. 11000
TEL: 52-55-9178-4270
FAX: 52-55-5202-3714

先鋒股份有限公司

台北市內湖區瑞光路407號8樓
電話：(02) 2657-3588

先鋒電子（香港）有限公司

香港九龍尖沙咀海港城世界商業中心
9樓901-6室
電話：(0852) 2848-6488

Published by Pioneer Corporation.
Copyright © 2010-2016 by Pioneer
Corporation. All rights reserved.