

Pioneer

Operation Manual

CD RDS RECEIVER

DEH-8400BT



Made for



iPod



iPhone



English

Thank you for purchasing this PIONEER product.

To ensure proper use, please read through this manual before using this product. It is especially important that you read and observe **WARNING**s and **CAUTION**s in this manual. *Please keep the manual in a safe and accessible place for future reference.*

01 Before you start

- About this unit **3**
- In case of trouble **3**
- Demo mode **4**
- About this manual **4**

02 Operating this unit

- Head unit **5**
- Optional remote control **5**
- Set up menu **5**
- Basic operations **6**
- Menu operations identical for function settings/audio adjustments/initial settings/lists **7**
- Tuner **7**
- CD/CD-R/CD-RW and external storage devices (USB, SD) **11**
- iPod **13**
- Audio adjustments **15**
- Using Bluetooth wireless technology **17**
- Initial settings **21**
- Other functions **22**

Additional information

- Troubleshooting **25**
- Error messages **25**
- Handling guidelines **28**
- Compressed audio compatibility (disc, USB, SD) **29**
- iPod compatibility **31**
- Sequence of audio files **31**
- Bluetooth profiles **31**
- Copyright and trademark **32**
- Specifications **33**

Before you start



If you want to dispose this product, do not mix it with general household waste. There is a separate collection system for used electronic products in accordance with legislation that requires proper treatment, recovery and recycling.

Private households in the member states of the EU, in Switzerland and Norway may return their used electronic products free of charge to designated collection facilities or to a retailer (if you purchase a similar new one).

For countries not mentioned above, please contact your local authorities for the correct method of disposal.

By doing so you will ensure that your disposed product undergoes the necessary treatment, recovery and recycling and thus prevent potential negative effects on the environment and human health. ▣

About this unit

The tuner frequencies on this unit are allocated for use in Western Europe, Asia, the Middle East, Africa and Oceania. Use in other areas may result in poor reception. The RDS (radio data system) function only operates in areas with broadcasting RDS signals for FM stations.

CAUTION

This product is a class 1 laser product classified under the Safety of laser products, IEC 60825-1:2007, and contains a class 1M laser module. To ensure continued safety, do not remove any covers or attempt to gain access to the inside of the product. Refer all servicing to qualified personnel.

CLASS 1 LASER PRODUCT

CAUTION—CLASS 1M INVISIBLE LASER RADIATION WHEN OPEN, DO NOT VIEW DIRECTLY WITH OPTICAL INSTRUMENTS.

⚠ CAUTION

- Do not allow this unit to come into contact with liquids. Electrical shock could result. Also, damage to this unit, smoke, and overheating could result from contact with liquids.
- The Pioneer CarStereo-Pass is for use only in Germany.
- Always keep the volume low enough to hear outside sounds.
- Avoid exposure to moisture.
- If the battery is disconnected or discharged, any preset memory will be erased.

Note

Function setting operations are completed even if the menu is cancelled before the operations are confirmed. ▣



In case of trouble

Should this unit fail to operate properly, please contact your dealer or nearest authorized PIONEER Service Station. ▣

Demo mode

Important

- Failure to connect the red lead (ACC) of this unit to a terminal coupled with ignition switch on/off operations may lead to battery drain.
- Remember that if the feature demo continues operating when the car engine is turned off, it may drain battery power.

The demo starts automatically if you do not operate this unit within about 30 seconds since it was last operated or if the ignition switch is set to ACC or ON while it is turned off. To cancel the demo mode, press and hold (/DISP). Press and hold (/DISP) again to start. You can also deactivate demo mode in the initial settings. Select **Demonstration** (*demo display setting*) and turn off the demo display. For details, refer to *Initial settings* on page 21. 

About this manual

- In the following instructions, USB memories, USB portable audio players, and SD memory cards are collectively referred to as “external storage devices (USB, SD)”. If only USB memories and USB portable audio players are indicated, they are collectively referred to as “USB storage devices”.
- In this manual, iPod and iPhone will be referred to as “iPod”. 

Operating this unit

Head unit

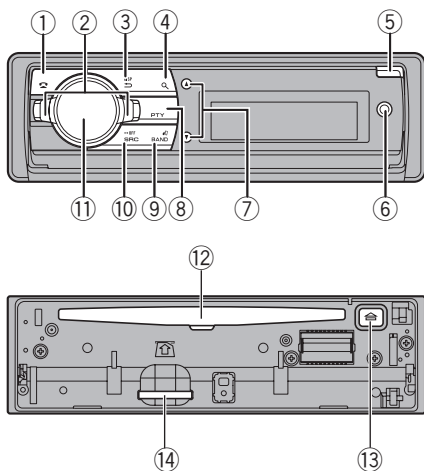

Part	Part
① (phone/on hook)	⑧ PTY
② LEVER	⑨ BAND/ (iPod)
③ DISP	⑩ SRC/OFF
④ (list)	⑪ MULTI-CONTROL (M.C.)
⑤ Open button	⑫ Disc loading slot
⑥ AUX input jack (3.5 mm stereo jack)	⑬ (eject)
⑦ /	⑭ SD memory card slot Remove the front panel to access the SD memory card slot.

CAUTION

Use a Pioneer USB cable when connecting the USB audio player/USB memory device as devices connected to the unit directly will protrude out, which is dangerous.

Do not use unauthorized products.

Optional remote control

The remote control CD-SR110 is sold separately.

Remote controller buttons marked with the same numbers as on the unit operate in the same way as the corresponding unit button regardless of button name.

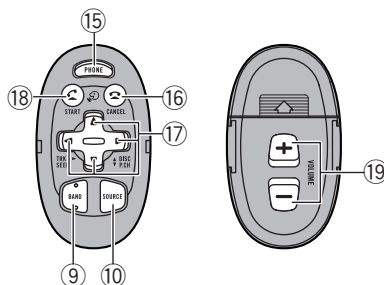

Part	Operation
⑮ PHONE	Press to display the phone menu. Press and hold to display the connection menu. Press to reject an incoming call or cancel making a call.
⑯ CAN-CEL	While operating the phone, press to end a call or reject an incoming call.
⑰	Press to perform manual seek tuning, fast forward, reverse and track search controls. Also used for controlling functions.
⑱ START	Press to start talking on the phone while operating a phone. Press to switch between callers on hold.
⑲ VOLUME	Press to increase or decrease volume.

Set up menu

When you turn the ignition switch to ON after installation, set up menu appears on the display.

You can set up the menu options below.

Operating this unit

1 After installation of this unit, turn the ignition switch to ON.

SET UP appears.

2 Turn M.C. to switch to YES.

- If you do not operate for 30 seconds, the set up menu will not be displayed.
- If you prefer not to set up at this time, turn M.C. to switch to NO.

If you select NO, you cannot set up in the set up menu.

3 Press M.C. to select.

4 Perform the following procedures to set the menu.

To proceed to the next menu option, you need to confirm your selection.

Language select (multi-language)

- 1 Turn M.C. to select the desired language.
English—Français—Italiano—Español—
Deutsch—Nederlands—РУССКИЙ
- 2 Press M.C. to confirm the selection.

Calendar (setting the date)

- 1 Turn M.C. to change the year.
- 2 Press M.C. to select day.
- 3 Turn M.C. to change the day.
- 4 Press M.C. to select month.
- 5 Turn M.C. to change the month.
- 6 Press M.C. to confirm the selection.

Clock (setting the clock)

- 1 Turn M.C. to adjust hour.
- 2 Press M.C. to select minute.
- 3 Turn M.C. to adjust minute.
- 4 Press M.C. to confirm the selection.

FM step (FM tuning step)

- 1 Turn M.C. to select the FM tuning step.
50kHz (50 kHz)—100kHz (100 kHz)
- 2 Press M.C. to confirm the selection.

Contrast (display contrast setting)

- 1 Turn M.C. to adjust the contrast level.
0 to 15 is displayed as the level is increased or decreased.
- 2 Press M.C. to confirm the selection.

Demonstration (demo display setting)

- 1 Turn M.C. to set the demo display to off.
- 2 Press M.C. to confirm the selection.
Quit appears.

5 To finish your settings, turn M.C. to select YES.

- If you prefer to change your setting again, turn M.C. to switch to NO.

6 Press M.C. to select.

Notes

- Because demonstration mode is the function for displaying at stores, do not use this function while driving.
- You can set up the menu options in the initial settings. For details about the settings, refer to *Initial settings* on page 21.
- You can cancel set up menu by pressing SRC/OFF. 

Basic operations

Important

- Handle gently when removing or attaching the front panel.
- Avoid subjecting the front panel to excessive shock.
- Keep the front panel out of direct sunlight and high temperatures.
- To avoid damaging the device or vehicle interior, remove any cables and devices attached to the front panel before detaching it.

Operating this unit

Removing the front panel to protect your unit from theft

The front panel can be detached to deter theft.

① Press the open button to open the front panel.

② Grip the left side of the front panel and pull it gently outward.

Take care not to grip it too tightly or to drop the front panel and protect it from contact with water or other fluids to prevent permanent damage.

③ Always keep the detached front panel in a protection device such as a protection case.

Re-attaching the front panel

① Reattach the front panel by holding it upright to the unit and clipping it securely into the mounting hooks.

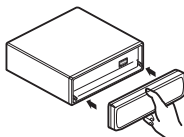

Turning the unit on

① Press **SRC/OFF** to turn the unit on.

Turning the unit off

① Press and hold **SRC/OFF** until the unit turns off.

Selecting a source

① Press **SRC/OFF** to cycle between:
TUNER (tuner)—**CD** (CD player)—**USB1** (USB1)/**iPod1** (iPod1)—**USB2** (USB2)/**iPod2** (iPod2)—**SD** (SD memory card)—**AUX** (AUX)—**BT Audio** (BT audio)

Adjusting the volume

① Turn **M.C.** to adjust the volume.

- If connecting both **USB1** (USB storage device1)/**iPod1** (iPod connected using USB input1) and **USB2** (USB storage device2)/**iPod2** (iPod connected using USB input2) at the same time, use a Pioneer USB cable (CD-U50E) in addition to the regular Pioneer USB cable.

Menu operations identical for function settings/audio adjustments/initial settings/lists

Returning to the previous display

Returning to the previous list/category. (the folder/category one level higher.)

① Press **DISP**.

Turning the demo display on or off

① Press and hold **DISP**.

Returning to the ordinary display

Canceling the initial setting menu

① Press **BAND/**.

Returning to the ordinary display from the list/category

① Press **BAND/**.

Selecting a function or list

① Turn **M.C.** or **LEVER**.

- In this manual, "Turn **M.C.**" is used to describe the operation used to select a function or list.

CAUTION

For safety reasons, park your vehicle when removing the front panel.

Notes

- When this unit's blue/white lead is connected to the vehicle's auto-antenna relay control terminal, the vehicle's antenna extends when this unit's source is turned on. To retract the antenna, turn the source off.
- When there are two USB storage devices connected to this unit and you want to switch between them for playback, disconnect communications for the USB storage device first before proceeding.

Tuner

Basic operations

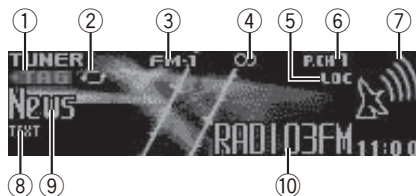

RDS

Operating this unit

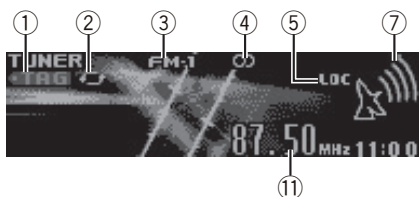

Non-RDS or MW/LW

- ① **TAG** indicator
- ② Tags transferring indicator
- ③ Band indicator
- ④ \odot (stereo) indicator
- ⑤ **LOC** indicator
Appears when local seek tuning is on.
- ⑥ Preset number indicator
- ⑦ Signal level indicator
- ⑧ **TEXT** indicator
Shows when the radio text is received.
- ⑨ **PTY** label indicator
- ⑩ Program service name
- ⑪ Frequency indicator

Selecting a band

- 1 Press **BAND/** until the desired band (**FM-1**, **FM-2**, **FM-3** for FM or **MW/LW**) is displayed.

Manual tuning (step by step)

- 1 Turn **LEVER**.

Seeking

- 1 Turn and hold down **LEVER**.
 - While turning and holding down **LEVER**, you can skip stations. Seek tuning starts as soon as you release **LEVER**.

Using PI Seek

If the tuner cannot find a suitable station, or the reception status deteriorates, the unit automatically searches for a different station with the same programming. During the search, **PI seek** is displayed and the sound is muted.

Using Auto PI Seek for preset stations

When preset stations cannot be recalled, the unit can be set to perform PI Seek during preset recall.

- The default setting for Auto PI Seek is off. Refer to **Auto PI (auto PI seek)** on page 21.

Storing and recalling stations for each band

1 Press **Q** (list).

The preset screen is displayed.

2 Use **M.C.** to store the selected frequency in the memory.

Turn to change the preset number. Press and hold to store.

3 Use **M.C.** to select the desired station.

Turn to change the station. Press to select.

- All stations stored for FM bands can be recalled from each independent FM band.
- You can tune the channel up or down manually by pressing Δ or ∇ .
- Press **BAND/** or **Q** (list) to return to the ordinary display.

Switching the RDS display

RDS (radio data system) contains digital information that helps search for the radio stations.

● Press \leftrightarrow /DISP.

PTY information and frequency or program service name—song title and artist name

- PTY information and the frequency appear on the display for eight seconds.

Using PTY functions

You can tune in to a station using PTY (program type) information.

Operating this unit

Searching for an RDS station by PTY information
You can search for general types of broadcasting programs, such as those listed in the following section. Refer to *PTY list* on this page.

- ① Press **PTY**.
- ② Turn **LEVER** left or right to select the desired setting.

News&Inf—Popular—Classics—Others

③ Press **M.C.** to begin the search.
The unit searches for a station broadcasting that type of program. When a station is found, its program service name is displayed.

PTY (program type ID code) information is listed in the following section. Refer to *PTY list* on this page.

To cancel the search, press **M.C.** again.

The program of some stations may differ from that indicated by the transmitted PTY.

If no station is broadcasting the type of program you searched for, **Not found** is displayed for about two seconds and then the tuner returns to the original station.

- *iPod touch 4th generation*
- *iPod touch 3rd generation*
- *iPod touch 2nd generation*
- *iPod touch 1st generation*
- *iPod classic 160GB*
- *iPod classic 120GB*
- *iPod classic*
- *iPod nano 6th generation*
- *iPod nano 5th generation*
- *iPod nano 4th generation*
- *iPod nano 3rd generation*
- *iPhone 4*
- *iPhone 3GS*
- *iPhone 3G*
- *iPhone*

However, tag information can be stored in this unit even while other iPod models are used.

The song information (tag) can be saved from the broadcasting station to your iPod. The songs will show up in a playlist called “Tagged playlist” in iTunes the next time you sync your iPod. Then you can directly buy the songs you want from the iTunes Store.

- The tagged songs and the song that you can buy from the iTunes Store may be different. Make sure to confirm the song before you make the purchase.

PTY list

News&Inf

News (News), **Affairs** (Current affairs), **Info** (Information), **Sport** (Sports), **Weather** (Weather), **Finance** (Finance)

Popular

Pop Mus (Popular music), **Rock Mus** (Rock music), **Easy Mus** (Easy listening), **Oth Mus** (Other music), **Jazz** (Jazz), **Country** (Country music), **Nat Mus** (National music), **Oldies** (Oldies music), **Folk mus** (Folk music)

Classics

L. Class (Light classical), **Classic** (Classical)

Others

Educate (Education), **Drama** (Drama), **Culture** (Culture), **Science** (Science), **Varied** (Varied), **Children** (Children's), **Social** (Social affairs), **Religion** (Religion), **Phone In** (Phone in), **Touring** (Travel), **Leisure** (Leisure), **Document** (Documentaries)

Storing the tag information to this unit

- ① Tune in to the broadcast station.
- ② Press and hold **M.C.** if **TAG** is indicated in the display while desired song is broadcasting.
 - While storing the tag data on this unit, **TAG** flashes.

Storing the tagged information to your iPod

- ① Connect an iPod to the USB cable using an iPod Dock Connector.
- ② Select **Tags transfer** from the function settings to transfer tag information from this unit to the iPod. Refer to **Tags transfer** (*Tags transfer*) on page 15.
 - If you switch sources during tag transfer, the transfer will stop. To cancel the transfer, select **Tags transfer** from the function settings and then try transferring the tag information again.

Using iTunes tagging

This function can be operated with the following iPod models.

Using radio text

Displaying radio text

You can display the currently received radio text and the three most recent radio texts.

- 1 Press and hold down **Q** (list) to display radio text.
 - You can turn off radio text display by pressing **DISP, SRC/OFF** or **BAND/**.
 - When no radio text is received, **NO TEXT** appears in the display.
- 2 Turn **LEVER** left or right to recall the three most recent radio texts.
- 3 Press **▲** or **▼** to scroll.

Storing and recalling radio text

You can store data from up to six radio text transmissions to the **RT Memo 1** to **RT Memo 6** keys.

- 1 Display the radio text you want to store in the memory.
 - 2 Press **Q** (list).
The preset screen is displayed.
 - 3 Use **LEVER** to store the selected radio text.
Turn it to change the preset number. Press and hold down **M.C.** to store.
 - 4 Use **LEVER** to select the desired radio text.
Turn it to change the radio text. Press **M.C.** to select.
 - To return to the ordinary display, press **BAND/** or **Q** (list).
- The tuner automatically stores the three latest radio text broadcasts received, replacing the oldest text with the newest text.

Function settings

- 1 Press **M.C.** to display the main menu.
- 2 Turn **M.C.** to change the menu option and press to select **FUNCTION**.
- 3 Turn **M.C.** to select the function.

After selecting, perform the following procedures to set the function.

- If MW/LW band is selected, only **BSM**, **Local** and **Tuning Mode** are available.

BSM (best stations memory)

BSM (best stations memory) automatically stores the six strongest stations in the order of their signal strength.

- 1 Press **M.C.** to turn BSM on.
To cancel, press **M.C.** again.

Regional (regional)

When **Alternative FREQ** is used, the regional function limits the selection of stations to those broadcasting regional programs.

- 1 Press **M.C.** to turn the regional function on or off.

Local (local seek tuning)

Local seek tuning lets you tune in to only those radio stations with sufficiently strong signals for good reception.

- 1 Press **M.C.** to turn local on.
 - To cancel, press **M.C.** again.
- 2 Turn **LEVER** left or right to select the desired setting.

FM: **Level 1—Level 2—Level 3—Level 4**
MW/LW: **Level 1—Level 2**

The highest level setting allows reception of only the strongest stations, while lower levels allow the reception of weaker stations.

PTY search (program type selection)

You can tune in to a station using PTY (program type) information.

- 1 Turn **LEVER** left or right to select the desired setting.

News&Inf—Popular—Classics—Others

- 2 Press **M.C.** to begin the search.
For details, refer to *Searching for an RDS station by PTY information* on the previous page.

Traffic Announce (traffic announcement standby)

- 1 Press **M.C.** to turn traffic announcement standby on or off.

Alternative FREQ (alternative frequencies search)

When the tuner cannot get a good reception, the unit automatically searches for a different station in the same network.

- 1 Press **M.C.** to turn the alternative frequencies search on and off.

News interrupt (news program interruption)

- 1 Press **M.C.** to turn the NEWS function on or off.

Operating this unit

Tuning Mode (LEVER tuning setting)

You can assign a function to the **LEVER** on the unit. Select **Manual** (manual tuning) to tune up or down manually or select **Preset** (preset channel) to switch between preset channels.

- Press **M.C.** to select **Manual** or **Preset**.



CD/CD-R/CD-RW and external storage devices (USB, SD)

Basic operations

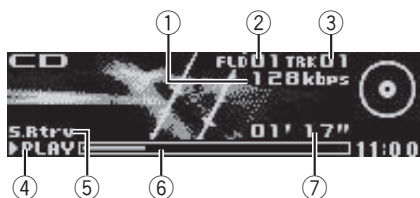

- Bit rate/sampling frequency indicator**
Shows the bit rate or sampling frequency of the current track (file) when the compressed audio is playing.
 - When playing back VBR (variable bit rate)-recorded AAC files, the average bit rate value is displayed. However, depending on the software used to decode AAC files, **VBR** may be displayed.
- Folder number indicator**
Shows the folder number currently playing when the compressed audio is playing.
- Track number indicator**
- PLAY/PAUSE indicator**
- S.Rtrv indicator**
Appears when Sound Retriever function is on.
- Song time (progress bar)**
- Play time indicator**

Open the front panel

- Press the open button.
Disc loading slot appears.

Playing a CD/CD-R/CD-RW

- Insert the disc into the disc loading slot with the label side up.

Ejecting a CD/CD-R/CD-RW

- Press **▲** (eject).

Playing songs on a USB storage device

- Use a Pioneer USB cable to connect the USB storage device to the unit.
 - Plug in the USB storage device using the USB cable.

Stopping playback of files on a USB storage device

- You may disconnect the USB storage device at any time.

Playing songs on an SD memory card

- Remove the front panel.
- Insert an SD memory card into the SD card slot. Insert it with the contact surface facing down, and press on the card until it clicks and completely locks into place.
- Re-attach the front panel.
- Press **SRC/OFF** to select **SD** as the source. Playback will start.

Stopping playback of files on an SD memory card

- Remove the front panel.
- Press on the SD memory card until it clicks. The SD memory card is ejected.
- Pull out the SD memory card.
- Re-attach the front panel.

Selecting a folder

- Press **▲** or **▼**.

Selecting a track

- Turn **LEVER**.

Fast forwarding or reversing

- Turn and hold down **LEVER** to the right or left.

Returning to root folder

- Press and hold **BAND/▲**.

Switching between compressed audio and CD-DA

- Press **BAND/▲**.

Switching between playback memory devices

You can switch between playback memory devices on USB storage devices with more than one Mass Storage Device-compatible memory device.

- Press **BAND/▲**.
 - You can switch between up to 32 different memory devices.

Notes

- When playing compressed audio, there is no sound during fast forward or reverse.

Operating this unit

- Disconnect USB storage devices from the unit when not in use.
- If there are two USB storage devices connected to this unit, the device connected to the input of the selected source is the one that is operated.
- Disconnect communications for the USB storage device before switching to operation of the other device.

Displaying text information

Selecting the desired text information

[1] Press **DISP**.

Notes

- Depending on the version of iTunes used to write MP3 files to a disc or media file types, incompatible text stored within an audio file may be displayed incorrectly.
- Text information items that can be changed depend on the media.

Selecting and playing files/tracks from the name list

If there are external storage devices (USB, SD) connected to the unit, this function is only available when **Music browse** is set to **OFF**. Refer to **Music browse** (*music browse*) on page 21.

1 Press **Q (list) to switch to the file/track name list mode.**

2 Use both LEVER and M.C. to select the desired file name (or folder name).

Changing the file or folder name

[1] Turn **LEVER**.

Playing

[1] When a file or track is selected, press **M.C.**

Viewing a list of the files (or folders) in the selected folder

[1] When a folder is selected, press **M.C.**

Playing a song in the selected folder

[1] When a folder is selected, press and hold **M.C.**

Browsing for a song

- This function is only available when a file on an external storage device (USB, SD) or a song on an iPod is being played.
- If there are external storage devices (USB, SD) connected to the unit, this function is only available when **Music browse** is set to **USB memory1**, **USB memory2** or **SD card**. Refer to **Music browse** (*music browse*) on page 21.

1 Press **Q (list) to switch to the top menu of the list search.**

2 Use M.C. to select a category/song.

Changing the name of the song or category

[1] Turn **M.C.**

Artists (artists)—**Albums** (albums)—**Songs** (songs)—**Genres** (genres)

Playing

[1] When a song is selected, press **M.C.**

Viewing a list of songs in the selected category

[1] When a category is selected, press **M.C.**

Playing a song in the selected category

[1] When a category is selected, press and hold **M.C.**

Searching the list by alphabet

[1] When a list for the selected category is displayed, press **Q** to switch to alphabet search mode.

[2] Turn **M.C.** to select a letter.

[3] Press **M.C.** to display the alphabetical list.

Notes

- This unit must create an index in order to facilitate **Artists**, **Albums**, **Songs**, and **Genres** searches. Typically, it will take approximately 70 seconds to create an index for 1 000 songs, and we recommend that up to 3 000 songs be used. Please note that certain types of file may take longer to index than others.
- Depending on the number of files in the USB storage device, there may be a delay when displaying a list.
- Keys may not have any effect during the creation of an index or list.
- Lists are recreated each time the unit is turned on.

Operating this unit

Function settings

1 Press **M.C.** to display the main menu.

2 Turn **M.C.** to change the menu option and press to select **FUNCTION**.

3 Turn **M.C.** to select the function.

After selecting, perform the following procedures to set the function.

Play mode (repeat play)

- 1 Press **M.C.** to select a repeat play range.
 - CD/CD-R/CD-RW**
 - **Disc repeat** – Repeat all tracks
 - **Track repeat** – Repeat the current track
 - **Folder repeat** – Repeat the current folder
 - External storage device (USB, SD)**
 - **All repeat** – Repeat all files
 - **Track repeat** – Repeat the current file
 - **Folder repeat** – Repeat the current folder

Random mode (random play)

- 1 Press **M.C.** to turn random play on or off.

Link play (link play)

- 1 Press **M.C.** to display the setting mode.
- 2 Turn **M.C.** to change the mode; press to select.
 - **Artist** – Plays an album of the artist currently being played.
 - **Album** – Plays a song from the album currently being played.
 - **Genre** – Plays an album from the genre currently being played.

The selected song/album will be played after the currently playing song.

- This function is only available for external storage devices (USB, SD).

Pause (pause)

- 1 Press **M.C.** to pause or resume.

Sound Retriever (sound retriever)

Automatically enhances compressed audio and restores rich sound.

- 1 Press **M.C.** to select the desired setting.
 - 1—2—OFF** (off)
 - 1** is effective for low compression rates, and **2** is effective for high compression rates.

iPod

Basic operations

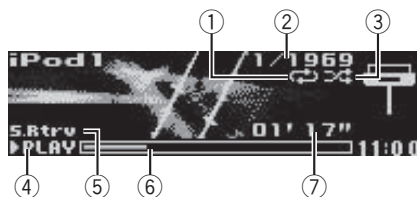

- 1 Repeat indicator
- 2 Song number indicator
- 3 Shuffle indicator
- 4 **PLAY/PAUSE** indicator
- 5 **S.Rtrv** indicator
Appears when Sound Retriever function is on.
- 6 Song time (progress bar)
- 7 Play time indicator

Playing songs on an iPod

- 1 Connect an iPod to the USB cable using an iPod Dock Connector.

Selecting a track (chapter)

- 1 Turn **LEVER**.

Fast forwarding or reversing

- 1 Turn and hold down **LEVER** to the right or left.

Selecting an album

- 1 Press **⏪** or **⏩**.

Notes

- The iPod cannot be turned on or off when the control mode is set to **AUDIO**.
- Disconnect headphones from the iPod before connecting it to this unit.
- The iPod will turn off about two minutes after the ignition switch is set to OFF.

Displaying text information

Selecting the desired text information

- 1 Press **DISP**.



Operating this unit

Browsing for a song

1 Press \mathcal{Q} (list) to switch to the top menu of the list search.

2 Use M.C. to select a category/song.

<p>Changing the name of the song or category</p> <p>1 Turn M.C.</p> <p>Playlists (playlists)—Artists (artists)—Albums (albums)—Songs (songs)—Podcasts (podcasts)—Genres (genres)—Composers (composers)—Audiobooks (audiobooks)</p>
<p>Playing</p> <p>1 When a song is selected, press M.C.</p>
<p>Viewing a list of songs in the selected category</p> <p>1 When a category is selected, press M.C.</p>
<p>Playing a song in the selected category</p> <p>1 When a category is selected, press and hold M.C.</p>
<p>Searching the list by alphabet</p> <p>1 When a list for the selected category is displayed, press \mathcal{Q} to switch to alphabet search mode.</p> <p>2 Turn M.C. to select a letter.</p> <p>3 Press M.C. to display the alphabetical list.</p>

Notes

- You can play playlists created with the PC application (MusicSphere). The application will be available on our website.
- Playlists that you created with the PC application (MusicSphere) are displayed in abbreviated form.

Playing songs related to the currently playing song

You can play songs from the following lists.

- Album list of the currently playing artist
- Song list of the currently playing album
- Album list of the currently playing genre

1 Press and hold M.C. to switch to link play mode.

2 Turn M.C. to change the mode; press to select.

- Artist** – Plays an album of the artist currently being played.

- Album** – Plays a song from the album currently being played.
- Genre** – Plays an album from the genre currently being played.

The selected song/album will be played after the currently playing song.

Notes

- The selected song/album may be canceled if you operate functions other than link search (e.g. fast forward and reverse).
- Depending on the song selected to play, the end of the currently playing song and the beginning of the selected song/album may be cut off.

Operating this unit's iPod function from your iPod

You can listen to the sound from your iPod applications using your car's speakers, when **APP** is selected.

This function is not compatible with the following iPod models.

— iPod with video

— iPod nano 1st generation

APP Mode is compatible with the following iPod models.

- iPod touch 4th generation (software version 4.1 or later)
- iPod touch 3rd generation (software version 3.0 or later)
- iPod touch 2nd generation (software version 3.0 or later)
- iPod touch 1st generation (software version 3.0 or later)
- iPod nano 6th generation (software version 1.0 or later)
- iPod nano 5th generation (software version 1.0.2 or later)
- iPhone 4 (software version 4.1 or later)
- iPhone 3GS (software version 3.0 or later)
- iPhone 3G (software version 3.0 or later)
- iPhone (software version 3.0 or later)

1 Press **BAND/** to switch the control mode.

- iPod** – This unit's iPod function can be operated from the connected iPod.

Operating this unit

- **APP** – Play back the sound from your iPod applications.
- **AUDIO** – This unit's iPod function can be operated from this unit.

Function settings

1 Press M.C. to display the main menu.

2 Turn M.C. to change the menu option and press to select FUNCTION.

3 Turn M.C. to select the function.

After selecting, perform the following procedures to set the function.

Play mode (repeat play)

- ① Press **M.C.** to select a repeat play range.
- **Repeat One** – Repeat the current song
 - **Repeat All** – Repeat all songs in the selected list

Shuffle mode (shuffle)

- ① Press **M.C.** to select your favorite setting.
- **Shuffle Songs** – Play back songs in the selected list in random order.
 - **Shuffle Albums** – Play back songs from a randomly selected album in order.
 - **Shuffle OFF** – Cancel random play.

Shuffle all (shuffle all)

- ① Press **M.C.** to turn shuffle all on.
To turn off, set **Shuffle mode** in the **FUNCTION** menu to off.

Link play (link play)

- ① Press **M.C.** to display the setting mode.
② Turn **M.C.** to change the mode; press to select.
For details about the settings, refer to *Playing songs related to the currently playing song* on the previous page.

Pause (pause)

- ① Press **M.C.** to pause or resume.

Tags transfer (Tags transfer)

- ① Press **M.C.** to store the tag information. Refer to *Using iTunes tagging* on page 9.

Audiobooks (audiobook speed)

- ① Press **M.C.** to select your favorite setting.
- **Faster** – Playback at a speed faster than normal
 - **Normal** – Playback at normal speed
 - **Slower** – Playback at a speed slower than normal

Sound Retriever (sound retriever)

- ① Press **M.C.** to select the desired setting.
1—2—OFF (off)
1 is effective for low compression rates, and **2** is effective for high compression rates.

Notes

- Switching the control mode to **iPod** pauses song playback. Operate the iPod to resume playback.
- The following functions are still accessible from the unit even if the control mode is set to **iPod/APP**.
 - Pausing
 - Fast forward/reverse
 - Track up/down
- When the control mode is set to **iPod/APP**, only **Pause**, **Tags transfer** or **Sound Retriever** is available.
- The browse function cannot be operated from this unit.

Audio adjustments

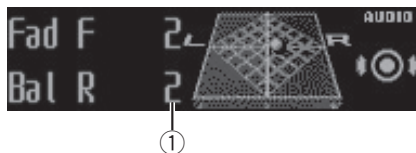

- ① Audio display
Shows the audio adjustment status.

1 Press M.C. to display the main menu.

2 Turn M.C. to change the menu option and press to select AUDIO.

Operating this unit

3 Turn M.C. to select the audio function.

After selecting, perform the following procedures to set the audio function.

Fader/Balance (fader/balance adjustment)

- 1 Press **M.C.** to display the setting mode.
- 2 Press **M.C.** to cycle between fader (front/rear) and balance (left/right).
- 3 Turn **M.C.** to adjust the front/rear speaker balance.
 - The front/rear speaker balance cannot be adjusted when the rear output setting is **Rear SP:S/W**. Refer to **S/W control (rear output and subwoofer setting)** on page 21.
- 4 Turn **M.C.** to adjust the left/right speaker balance.

Preset EQ (equalizer recall)

- 1 Press **M.C.** to display the setting mode.
- 2 Turn **M.C.** to select an equalizer curve.
Powerful—Natural—Vocal—Custom1—Custom2—Flat—Super bass

G.EQ (equalizer adjustment)

You can adjust the currently selected equalizer curve setting as desired. Adjusted equalizer curve settings are stored in **Custom1** or **Custom2**.

- A separate **Custom1** curve can be created for each source. If you make adjustments when a curve other than **Custom2** is selected, the equalizer curve settings will be stored in **Custom1**.
 - A **Custom2** curve that is common for all sources can be created. If you make adjustments when the **Custom2** curve is selected, the **Custom2** curve will be updated.
- 1 Recall the equalizer curve you want to adjust.
 - 2 Press **M.C.** to display the setting mode.
 - 3 Press **M.C.** to cycle between equalizer band and level.
 - 4 Turn **M.C.** to select the equalizer band to adjust.
100Hz—315Hz—1.25kHz—3.15kHz—8kHz
Turn **M.C.** to adjust the equalizer curve.
+6 to **-6** is displayed as the equalizer curve is increased or decreased.

Loudness (loudness)

Loudness compensates for deficiencies in the low-frequency and high-frequency ranges at low volume.

- 1 Press **M.C.** to display the setting mode.
- 2 Press **M.C.** to turn loudness on or off.
- 3 Turn **M.C.** to select the desired setting.
Low (low)—Mid (mid)—High (high)

Subwoofer1 (subwoofer on/off setting)

This unit is equipped with a subwoofer output which can be turned on or off.

- 1 Press **M.C.** to display the setting mode.
- 2 Press **M.C.** to turn subwoofer output on or off.
- 3 Turn **M.C.** to select the phase for the subwoofer output.
Turn **M.C.** to the left to select reverse phase, and **Reverse** appears in the display. Turn **M.C.** to the right to select normal phase, and **Normal** appears in the display.

Subwoofer2 (subwoofer adjustment)

The cut-off frequency and output level can be adjusted when the subwoofer output is on. Only frequencies lower than those in the selected range are outputted from the subwoofer.

- 1 Press **M.C.** to display the setting mode.
- 2 Press **M.C.** to cycle between the cut-off frequency and the output level for the subwoofer.
- 3 Turn **M.C.** to select the cut-off frequency.
50Hz—63Hz—80Hz—100Hz—125Hz
- 4 Turn **M.C.** to adjust the output level for the subwoofer.

The subwoofer level increases or decreases each time you turn **M.C.** **+6** to **-24** is displayed as the level is increased or decreased.

Bass Booster (bass boost)

- 1 Press **M.C.** to display the setting mode.
- 2 Turn **M.C.** to select a desired level.
0 to **+6** is displayed as the level is increased or decreased.

HPF (high pass filter adjustment)

When you do not want low sounds from the subwoofer output frequency range to play from the front or rear speakers, turn on the HPF (high pass filter). Only frequencies higher than those in the selected range are output from the front or rear speakers.

- 1 Press **M.C.** to display the setting mode.
- 2 Press **M.C.** to turn high pass filter on or off.
- 3 Turn **M.C.** to select the cut-off frequency.
50Hz—63Hz—80Hz—100Hz—125Hz

Operating this unit

SLA (source level adjustment)

SLA (Source level adjustment) lets you adjust the volume level of each source to prevent radical changes in volume when switching between sources.

- When selecting FM as the source, you cannot switch to **SLA**.
- Settings are based on the FM volume level, which remains unchanged.
- The MW/LW volume level can also be adjusted with this function.

- 1 Press **M.C.** to display the setting mode.
- 2 Turn **M.C.** to adjust the source volume.
Adjustment range: **+4** to **-4**



Using Bluetooth wireless technology

Using Bluetooth telephone

Important

- Since this unit is on standby to connect with your cellular phone via Bluetooth wireless technology, using it without the engine running can drain the battery power.
- Operations may vary depending on the kind of cellular phone.
- Advanced operations that require attention such as dialing numbers on the monitor, using the phone book, etc., are prohibited while driving. Park your vehicle in a safe place when using these advanced operations.

Setting up for hands-free phoning

Before you can use the hands-free phoning function you must set up the unit for use with your cellular phone.

- 1 Connection
Operate the Bluetooth telephone connection menu. Refer to *Connection menu operation* on this page.
- 2 Function settings
Operate the Bluetooth telephone function menu. Refer to *Phone menu operation* on page 20.

Basic operations

Making a phone call	<ul style="list-style-type: none"> • Refer to <i>Phone menu operation</i> on page 20.
Answering an incoming call	<ol style="list-style-type: none"> 1 When a call is received, press M.C.
Ending a call	<ol style="list-style-type: none"> 1 Press .
Rejecting an incoming call	<ol style="list-style-type: none"> 1 When a call is received, press .
Answering a call waiting	<ol style="list-style-type: none"> 1 When a call is received, press M.C.
Switching between callers on hold	<ol style="list-style-type: none"> 1 Press M.C.
Canceling call waiting	<ol style="list-style-type: none"> 1 Press .
Adjusting the other party's listening volume	<ol style="list-style-type: none"> 1 Turn LEVER while talking on the phone. <ul style="list-style-type: none"> • When private mode is on, this function is not available.
Turning private mode on or off	<ol style="list-style-type: none"> 1 Press BAND/ while talking on the phone.
Switching the information display	<ol style="list-style-type: none"> 1 Press /DISP while talking on the phone.

Notes

- If private mode is selected on the cellular phone, hands-free phoning may not be available.
- The estimated call time appears in the display (this may differ slightly from the actual call time).

Connection menu operation

Important

- Be sure to park your vehicle in a safe place and apply the parking brake when performing this operation.
- Connected devices may not operate properly if more than one Bluetooth device is connected at a time (e.g. a phone and a separate audio player are connected simultaneously).

Operating this unit

1 Press and hold to display the connection menu.

- You cannot operate this step during a call.

2 Turn **M.C.** to select the function.

After selecting, perform the following procedures to set the function.

Device list (connecting or disconnecting a device from the device list)

- When no device is selected in the device list, this function is not available.
- Press **M.C.** to display the setting mode.
 - Turn **M.C.** to select the name of a device you want to connect/disconnect.
 - Press and hold **M.C.** to switch the Bluetooth device address and device name.
 - Press **M.C.** to connect/disconnect the selected device.

Once the connection is established, **Connected** is displayed.

Delete device (deleting a device from the device list)

- When no device is selected in the device list, this function is not available.
- Press **M.C.** to display the setting mode.
 - Turn **M.C.** to select the name of a device you want to delete.
 - Press and hold **M.C.** to switch the Bluetooth device address and device name.
 - Press **M.C.** to display **Delete YES**.
 - Press **M.C.** to delete a device information from the device list.
- While this function is in use, do not turn off the engine.

Add device (connecting a new device)

- Press **M.C.** to start searching.
 - To cancel, press **M.C.** while searching.
 - If this unit fails to find any available cellular phones, **Not found** is displayed.
- Turn **M.C.** to select a device from the device list.
 - Press and hold **M.C.** to switch the Bluetooth device address and device name.
- Press **M.C.** to connect the selected device.
 - To complete the connection, check the device name (**Pioneer BT Unit**). Enter the PIN code on your device if necessary.
 - PIN code is set to **0000** as the default. You can change this code.
 - 6-digit number appears on the display of this unit. Once the connection is established, this number disappears.
 - If you are unable to complete the connection using this unit, use the device to connect to the unit.
 - If three devices are already paired, **Device Full** is displayed and it is not possible to perform this operation. In this case, delete a paired device first.

Special device (setting a special device)

Bluetooth devices that are difficult to establish a connection with are called special devices. If your Bluetooth device is listed as a special device, select the appropriate one.

- Press **M.C.** to display the setting mode.
 - If three devices are already paired, **Device Full** is displayed and it is not possible to perform this operation. In this case, delete a paired device first.
- Turn **M.C.** to display a special device. Press to select.
- Turn **M.C.** to display this unit's device name, Bluetooth device address and PIN code.
- Use a device to connect to this unit.
 - To complete the connection, check the device name (**Pioneer BT Unit**) and enter the PIN code on your device.
 - PIN code is set to **0000** as the default. You can change this code.

Auto connect (connecting to a Bluetooth device automatically)

- Press **M.C.** to turn automatic connection on or off.

Visibility (setting the visibility of this unit)

Operating this unit

To check the availability of this unit from other devices, Bluetooth visibility of this unit can be turned on.

- 1 Press **M.C.** to turn the visibility of this unit on or off.
 - While setting **Special device**, Bluetooth visibility of this unit is turned on temporarily.

Pin code input (PIN code input)

To connect your device to this unit via Bluetooth wireless technology, you need to enter a PIN code on your device to verify the connection. The default code is **0000**, but you can change it with this function.

- 1 Press **M.C.** to display the setting mode.
- 2 Turn **M.C.** to select a number.
- 3 Press **M.C.** to move the cursor to the next position.
- 4 After inputting PIN code, press and hold **M.C.**
 - After inputting, pressing **M.C.** returns you to the PIN code input display, and you can change the PIN code.

Device INFO (Bluetooth device address display)

- 1 Press **M.C.** to display the setting mode.
- 2 Turn **M.C.** left to switch to the Bluetooth device address.
 - Turning **M.C.** right returns to the device name.

Bluetooth Audio

Important

- Depending on the Bluetooth audio player connected to this unit, the available operations will be limited to the following two levels:
 - A2DP profile (Advanced Audio Distribution Profile): You can only playback songs on your audio player.
 - AVRCP profile (Audio/Video Remote Control Profile): You can perform playback, pause playback, select songs, etc.
- Since there are a number of Bluetooth audio players available on the market, available operations will vary extensively. When operating your player with this unit, refer to the instruction manual that came with your Bluetooth audio player as well as this manual.
- Information related to a song (such as the elapsed playing time, song title, song index, etc.) cannot be displayed on this unit.

- As the signal from your cellular phone may cause noise, avoid using it when you are listening to songs on your Bluetooth audio player.
- When a call is in progress on the cellular phone connected to this unit via Bluetooth wireless technology, the sound of the Bluetooth audio player connected to this unit is muted.
- When the Bluetooth audio player is in use, you cannot connect to a Bluetooth telephone automatically.
- Playback continues even if you switch from your Bluetooth audio player to another source while listening to a song.

Setting up for Bluetooth audio

Before you can use the Bluetooth audio function you must set up the unit for use with your Bluetooth audio player. This entails establishing a Bluetooth wireless connection between this unit and your Bluetooth audio player, and pairing your Bluetooth audio player with this unit.

Basic operations



- 1 Device name
 - Shows the device name of the connected Bluetooth audio player.

Fast forwarding or reversing

- 1 Turn and hold down **LEVER** to the right or left.

Selecting a track

- 1 Turn **LEVER**.

Starting playback

- 1 Press **BAND/⏪**.

Operating this unit

Function settings

1 Press M.C. to display the main menu.

2 Turn M.C. to change the menu option and press to select FUNCTION.

3 Turn M.C. to select the function.

After selecting, perform the following procedures to set the function.

Play (play)

① Press **M.C.** to start playback.

Stop (stop)

① Press **M.C.** to stop the playback.

Pause (pause)

① Press **M.C.** to turn pause on.

Phone menu operation

⚠ Important

Be sure to park your vehicle in a safe place and apply the parking brake when performing this operation.

1 Press  to display the phone menu.

2 Turn M.C. to select the function.

After selecting, perform the following procedures to set the function.

Missed calls (missed call history)

Dialed calls (dialed call history)

Received calls (received call history)

① Press **M.C.** to display the phone number list.

② Turn **M.C.** to select a name or phone number.

③ Press **M.C.** to make a call.

- To display details about the contact you selected, press and hold **M.C.**

PhoneBook (phone book)

- The phone book in your cellular phone will be transferred automatically when the phone is connected to this unit.
- Depending on the cellular phone, the phone book may not be transferred automatically. In this case, operate your cellular phone to transfer the phone book. The visibility of this unit should be on. Refer to **Visibility** (*setting the visibility of this unit*) on page 18.
 - ① Press **M.C.** to display **SEARCH** (alphabetical list).
 - ② Turn **M.C.** to select the first letter of the name you are looking for.
 - Press and hold **M.C.** to select the desired character type.
 - ③ Press **M.C.** to display a registered name list.
 - ④ Turn **M.C.** to select the name you are looking for.
 - ⑤ Press **M.C.** to display the phone number list.
 - ⑥ Turn **M.C.** to select a phone number you want to call.
 - ⑦ Press **M.C.** to make a call.

Phone Function (phone function)

You can set **Auto answer**, **Ring tone** and **PH.B. Name view** from this menu. For details, refer to *Function and operation* on this page.

Function and operation

1 Display Phone Function.

Refer to **Phone Function** (*phone function*) on this page.

2 Press M.C. to display the function menu.

3 Turn M.C. to select the function.

After selecting, perform the following procedures to set the function.

Auto answer (automatic answering)

① Press **M.C.** to turn automatic answering on or off.

Ring tone (ring tone select)

① Press **M.C.** to turn the ring tone on or off.

PH.B.Name view (phone book name view)

① Press **M.C.** to switch between the lists of names.



Operating this unit

Initial settings



- ① Function display
- Shows the function status.

1 Press and hold SRC/OFF until the unit turns off.

2 Press M.C. and hold until the initial setting menu appears in the display.

3 Turn M.C. to select the initial setting.

After selecting, perform the following procedures to set the initial setting.

Language select (multi-language)

For your convenience, this unit equips multiple language display. You can select the language best suited to your first language.

- ① Press **M.C.** to select the language.

**English—Français—Italiano—Español—
Deutsch—Nederlands—РУССКИЙ**

Calendar (setting the date)

- ① Press **M.C.** to select the segment of the calendar display you wish to set.
Year—Day—Month
- ② Turn **M.C.** to set the date.

Clock (setting the clock)

- ① Press **M.C.** to select the segment of the clock display you wish to set.
Hour—Minute
- ② Turn **M.C.** to adjust the clock.

EngineTime alert (elapsed time display setting)

This setting allows you to measure the length of time that elapses from when the machine is turned on and display the amount of elapsed time per set period. Also, you will hear alarm.

- ① Press **M.C.** to select your favorite setting.
OFF—15Minutes—30Minutes

FM step (FM tuning step)

Normally, the FM tuning step setting employed for seek tuning is 50 kHz. The tuning step changes to 100 kHz automatically when the alternative frequencies search or traffic announcement standby function is in use. It may be preferable to set the tuning step to 50 kHz when the alternative frequencies search function is on.

- ① Press **M.C.** to select the FM tuning step.
50kHz (50 kHz)—100kHz (100 kHz)

Auto PI (auto PI seek)

The unit can automatically search for a different station with the same programming, even during preset recall.

- ① Press **M.C.** to turn Auto PI seek on or off.

Music browse (music browse)

When operating external storage devices (USB, SD), you can select files from the list.

- ① Press **M.C.** to select the setting.

OFF—USB memory1—USB memory2—SD card

Warning tone (warning tone setting)

If the front panel is not detached from the head unit within four seconds of turning off the ignition, a warning tone sounds. You can turn off the warning tone.

- ① Press **M.C.** to turn the warning tone on or off.

AUX (auxiliary input)

Activate this setting when using an auxiliary device connected to this unit.

- ① Press **M.C.** to turn auxiliary setting on or off.

Dimmer (dimmer setting)

To prevent the display from being too bright at night, the display is automatically dimmed when the car's headlights are turned on. You can turn the dimmer on or off.

- ① Press **M.C.** to turn dimmer on or off.

Contrast (display contrast setting)

- ① Turn **M.C.** to adjust the contrast level.
0 to 15 is displayed as the level is increased or decreased.

S/W control (rear output and subwoofer setting)

Operating this unit

This unit's rear output (rear speaker leads output and RCA rear output) can be used for full-range speaker (**Rear SP:F.Range**) or subwoofer (**Rear SP:S/W**) connection. If you switch the rear output setting to **Rear SP:S/W**, you can connect a rear speaker lead directly to a subwoofer without using an auxiliary amp.

- 1 Press **M.C.** to switch the rear output setting.
 - When no subwoofer is connected to the rear output, select **Rear SP:F.Range** (full-range speaker).
 - When a subwoofer is connected to the rear output, select **Rear SP:S/W** (subwoofer).
- Even if you change this setting, there will be no output unless you turn the subwoofer output on (refer to **Subwoofer1** (*subwoofer on/off setting*) on page 16).
- If you change this setting, subwoofer output in the audio menu will return to the factory settings.
- Both rear speaker lead outputs and RCA rear output are switched simultaneously in this setting.

Demonstration (demo display setting)

- 1 Press **M.C.** to turn the demo display on or off.

Ever-scroll (scroll mode setting)

When ever scroll is set to **ON**, recorded text information scrolls continuously in the display. Set to **OFF** if you prefer the information to scroll just once.

- 1 Press **M.C.** to turn the ever scroll on or off.

BT AUDIO (Bluetooth audio activation)

You need to activate the **BT Audio** source in order to use a Bluetooth audio player.

- 1 Press **M.C.** to turn the **BT Audio** source on or off.

Clear memory (resetting the Bluetooth wireless technology module)

Bluetooth device data can be deleted. To protect personal information, we recommend deleting this data before transferring the unit to other persons. The following settings will be deleted.

- phone book entries on the Bluetooth telephone
 - preset numbers on the Bluetooth telephone
 - registration assignment of the Bluetooth telephone
 - call history of the Bluetooth telephone
 - information of the connected Bluetooth telephone
 - PIN code of the Bluetooth device
- 1 Press **M.C.** to show the confirmation display. **YES** is displayed. Clearing memory is now on standby.

If you do not want to reset phone memory, turn **M.C.** to display **CANCEL** and press to select.
 - 2 Press **M.C.** to clear the memory. **Cleared** is displayed and the settings are deleted.
 - While this function is in use, do not turn off the engine.

BT Version info. (Bluetooth version display)

You can display the system versions of this unit and of Bluetooth module.

- 1 Press **M.C.** to display the information.
 - Turning **M.C.** or **LEVER** cycles between the system version of this unit and that of the Bluetooth module.

S/W UPDATE (updating the software)

This function is used to update this unit with the latest software. For information on the software and updating, refer to our website.

- Never turn the unit off while the software is being updated.
- 1 Press **M.C.** to display the data transfer mode. Follow the on-screen instructions to finish updating the software.



Other functions

Using an AUX source

- 1 Insert the stereo mini plug into the AUX input jack.
- 2 Press **SRC/OFF** to select **AUX** as the source.

Operating this unit

Note

AUX cannot be selected unless the auxiliary setting is turned on. For more details, refer to **AUX** (*auxiliary input*) on page 21.

Using different entertainment displays

You can enjoy entertainment displays while listening to each sound source.

Switching the display indication

- 1 Press **M.C.** to display the main menu.
- 2 Turn **M.C.** to change the menu option and press to select **ENTERTAINMENT**.
- 3 Turn **M.C.** to select the function.
- 4 Press **M.C.** to display the **Background**.
- 5 Turn **M.C.** to change the display.

Background visual—genre—background picture 1—background picture 2—background picture 3—background picture 4—simple display—movie screen —calendar

- Genre display changes depending on the genre of music.
- Genre display may not operate correctly depending on the application used to encode audio files.

Turning the clock display on or off

- 1 Press **M.C.** to display the main menu.
- 2 Turn **M.C.** to change the menu option and press to select **ENTERTAINMENT**.
- 3 Turn **M.C.** to select the function.
- 4 Press **M.C.** to select the desired setting.
Clock display—elapsed time display—clock off

Selecting the illumination color

This unit is equipped with multiple-color illumination. You can select desired colors for the keys and display of this unit. You also can customize the colors you want to use.

Selecting the key color from the illumination color list

You can select desired colors for the keys of this unit.

- 1 Press **M.C.** to display the main menu.
- 2 Turn **M.C.** to change the menu option and press to select **ILLUMI**.
- 3 Turn **M.C.** to display **Key** and press to select.
- 4 Turn **M.C.** to select the illumination color.

You can select one option from the following list.

- **27** preset colors (**WHITE** to **ROSE**)
- **SCAN** (cycle through all colors)
- 3 sets of colors (**WARM**, **AMBIENT**, **CALM**)
- **CUSTOM** (customized illumination color)

Notes

- When **SCAN** is selected, the system automatically cycles through the **27** preset colors.
- When **WARM** is selected, the system automatically cycles through the warm colors.
- When **AMBIENT** is selected, the system automatically cycles through the ambient colors.
- When **CALM** is selected, the system automatically cycles through the calm colors.
- When **CUSTOM** is selected, the customized color saved is selected.

Selecting the display color from the illumination color list

You can select the desired colors for the display of this unit.

- 1 Press **M.C.** to display the main menu.

Operating this unit

2 Turn M.C. to change the menu option and press to select ILLUMI.

3 Turn M.C. to switch to Display and press to select.

4 Turn M.C. to select the illumination color.

You can select one option from the following list.

- **27** preset colors (**WHITE** to **ROSE**)
- **SCAN** (cycle through all colors)
- 3 sets of colors (**WARM**, **AMBIENT**, **CALM**)
- **CUSTOM** (customized illumination color)

Note

For details about colors on the list, refer to *Selecting the key color from the illumination color list* on the previous page.

Selecting key and display color from the illumination color list

You can select the desired colors for the keys and display of this unit.

1 Press M.C. to display the main menu.

2 Turn M.C. to change the menu option and press to select ILLUMI.

3 Turn M.C. to display Key & Display and press to select.

4 Turn M.C. to select the illumination color.

You can select one option from the following list.

- **27** preset colors (**WHITE** to **ROSE**)
- **SCAN** (cycle through all colors)
- 3 sets of colors (**WARM**, **AMBIENT**, **CALM**)

Notes

- You cannot select **CUSTOM** in this function.
- Once you select a color in this function, colors on the keys and display of this unit automatically switch to the color you selected.

- For details about colors on the list, refer to *Selecting the key color from the illumination color list* on the previous page.

Customizing the illumination color

1 Press M.C. to display the main menu.

2 Turn M.C. to change the menu option and press to select ILLUMI.

3 Turn M.C. to display Key or Display. Press to select.

4 Press M.C. and hold until the customizing illumination color setting appears in the display.

5 Press M.C. to select the primary color.
R (red)—G (green)—B (blue)

6 Turn M.C. to adjust the brightness level.
Adjustment range: **0** to **60**

- You cannot select a level below **20** for all three of **R** (red), **G** (green), and **B** (blue) at the same time.
- You can also perform the same operation on other colors.

Notes

- You cannot create a custom illumination color when **SCAN** or a set of colors (**WARM**, **AMBIENT**, or **CALM**) is selected.
- You can create custom illumination colors for both **Key** and **Display**.

Additional information

Troubleshooting

Symptom	Cause	Action
The display automatically returns to the ordinary display.	You did not perform any operation within about 30 seconds.	Perform operation again.
The repeat play range changes unexpectedly.	Depending on the repeat play range, the selected range may change when another folder or track is being selected or during fast forwarding/reversing.	Select the repeat play range again.
A subfolder is not played back.	Subfolders cannot be played when Folder repeat (folder repeat) is selected.	Select another repeat play range.
NO XXXX appears when a display is changed (NO TITLE , for example).	There is no embedded text information.	Switch the display or play another track/file.
The display screen changes at random.	Demo mode is on.	<ul style="list-style-type: none"> Press and hold DISP to cancel demo mode. Turn off the demo display setting.
The display screen changes at random instead of displaying the clock continuously even with the clock display turned on.	Demo mode is on.	<ul style="list-style-type: none"> Press and hold DISP to cancel demo mode. Turn off the demo display setting.
The unit is malfunctioning. There is interference.	You are using a device, such as a cellular phone, that transmits electric waves near the unit.	Move electrical devices that may be causing the interference away from the unit.

Symptom	Cause	Action
The sound from the Bluetooth audio source is not played back.	There is a call in progress on a Bluetooth connected cellular phone. A Bluetooth connected cellular phone is currently being operated.	The sound will be played back when the call is terminated. Do not operate the cellular phone at this time.
	A call was made with a Bluetooth connected cellular phone and then immediately terminated. As a result, communication between this unit and the cellular phone was not terminated properly.	Reconnect the Bluetooth connection between this unit and the cellular phone.
Text information cannot be scrolled.	Display scrolling is stopped automatically when the temperature around this unit is 10°C or less.	Wait until it warms back up.
Movie playback is stopped and the simple display appears.	Movie playback is stopped automatically when the temperature around this unit is 10°C or less.	Wait until it warms back up.
Sound from the iPod cannot be heard.	The audio output direction may switch automatically when the Bluetooth and USB connections are used at the same time.	Use the iPod to change the audio output direction.

Error messages

When you contact your dealer or your nearest Pioneer Service Center, be sure to note the error message.

Additional information

CD player

Message	Cause	Action
ERROR-07, 11, 12, 17, 30	The disc is dirty.	Clean the disc.
	The disc is scratched.	Replace the disc.
ERROR-10, 11, 12, 15, 17, 30, A0	There is an electrical or mechanical error.	Turn the ignition switch OFF and back ON, or switch to a different source, then back to the CD player.
ERROR-15	The inserted disc is blank.	Replace the disc.
ERROR-23	Unsupported CD format.	Replace the disc.
FORMAT READ	Sometimes there is a delay between the start of playback and when you start to hear any sound.	Wait until the message disappears and you hear sound.
NO AUDIO	The inserted disc does not contain any playable files.	Replace the disc.
SKIPPED	The inserted disc contains DRM protected files.	Replace the disc.
PROTECT	All the files on the inserted disc are embedded with DRM.	Replace the disc.

External storage device (USB, SD)/iPod

Message	Cause	Action
NO DEVICE	No USB storage device or iPod is connected.	Connect a compatible USB storage device/iPod.
FORMAT READ	Sometimes there is a delay between the start of playback and when you start to hear any sound.	Wait until the message disappears and you hear sound.

Message	Cause	Action
NO AUDIO	There are no songs.	Transfer the audio files to the USB storage device and connect.
	The connected USB storage device has security enabled.	Follow the USB storage device instructions to disable the security.
SKIPPED	The connected USB storage device contains files embedded with Windows Media™ DRM 9/10.	Play an audio file not embedded with Windows Media DRM 9/10.
PROTECT	All the files in the USB storage device are embedded with Windows Media DRM 9/10.	Transfer audio files not embedded with Windows Media DRM 9/10 to the USB storage device and connect.
NOT COMPATIBLE	The USB device connected to is not supported by this unit.	<ul style="list-style-type: none"> • Connect a USB Mass Storage Class compliant device. • Disconnect your device and replace it with a compatible USB storage device.
	Non-compatible iPod	Disconnect your device and replace it with a compatible iPod.
Non-compatible SD storage device		Remove your device and replace it with a compatible SD storage device.

Additional information

Message	Cause	Action
CHECK USB	The USB connector or USB cable has short-circuited.	Check that the USB connector or USB cable is not caught in something or damaged.
	The connected USB storage device consumes more than 500 mA (maximum allowable current).	Disconnect the USB storage device and do not use it. Turn the ignition switch to OFF, then to ACC or ON and then connect only compliant USB storage devices.
	The iPod operates correctly but does not charge.	Make sure the connection cable for the iPod has not shorted out (e.g., not caught in metal objects). After checking, turn the ignition switch OFF and back ON, or disconnect the iPod and reconnect.
ERROR-19	Communication failed.	<ul style="list-style-type: none"> • Perform one of the following operations. <ul style="list-style-type: none"> –Turn the ignition switch OFF and back ON. –Disconnect or eject the external storage device. –Change to a different source. Then, return to the USB or SD source. • Disconnect the cable from the iPod. Once the iPod's main menu is displayed, reconnect the iPod and reset it.
	iPod failure.	Disconnect the cable from the iPod. Once the iPod's main menu is displayed, reconnect the iPod and reset it.

Message	Cause	Action
ERROR-23	USB storage device was not formatted with FAT12, FAT16 or FAT32.	USB storage device should be formatted with FAT12, FAT16 or FAT32.
ERROR-16	The iPod firmware version is old.	Update the iPod version.
	iPod failure.	Disconnect the cable from the iPod. Once the iPod's main menu is displayed, reconnect the iPod and reset it.
STOP	There are no songs in the current list.	Select a list that contains songs.
Not found	No related songs.	Transfer songs to the iPod.

Bluetooth device

Message	Cause	Action
ERROR-10	The power failed for the Bluetooth module of this unit.	Turn the ignition switch OFF and then to ACC or ON. If the error message is still displayed after performing the above action, please contact your dealer or an authorized Pioneer Service Station.



Additional information

Handling guidelines

Discs and player

Use only discs that feature either of the following two logos.



Use 12-cm discs. Do not use 8-cm discs or an adapter for 8-cm discs.

Use only conventional, fully circular discs. Do not use shaped discs.



Do not insert anything other than a CD into the CD loading slot.

Do not use cracked, chipped, warped, or otherwise damaged discs as they may damage the player.

Unfinalized CD-R/RW discs cannot be played back.

Do not touch the recorded surface of the discs.

Store discs in their cases when not in use.

Do not attach labels, write on or apply chemicals to the surface of the discs.

To clean a CD, wipe the disc with a soft cloth outward from the center.

Condensation may temporarily impair the player's performance. Let it rest for about one hour to adjust to a warmer temperature. Also, wipe any damp discs off with a soft cloth.

Playback of discs may not be possible because of disc characteristics, disc format, recorded application, playback environment, storage conditions, and so on.

Road shocks may interrupt disc playback.

When using discs that can be printed on label surfaces, check the instructions and the warnings of the discs. Depending on the discs, inserting and ejecting may not be possible. Using such discs may result in damage to this equipment.

Do not attach commercially available labels or other materials to the discs.

- The discs may warp making the disc unplayable.
- The labels may come off during playback and prevent ejection of the discs, which may result in damage to the equipment.

External storage device (USB, SD)

Address any questions you have about your external storage device (USB, SD) to the manufacturer of the device.

Do not leave the external storage device (USB, SD) in places with high temperatures.

Depending on the external storage device (USB, SD), the following problems may occur.

- Operations may vary.
- The storage device may not be recognized.
- Files may not be played back properly.

USB storage device

Connections via USB hub are not supported.

Do not connect anything other than a USB storage device.

Firmly secure the USB storage device when driving. Do not let the USB storage device fall onto the floor, where it may become jammed under the brake or accelerator pedal.

Depending on the USB storage device, the following problems may occur.

- The device may generate noise in the radio.

SD memory card

This unit supports only the following types of SD memory cards.

- SD
- miniSD
- microSD
- SDHC

Keep the SD memory card out of the reach of children. Should the SD memory card be swallowed, consult a doctor immediately.

Additional information

Do not touch the connectors of the SD memory card directly with your fingers or with any metal device.

Do not insert anything other than an SD memory card into the SD card slot. If a metal object (such as a coin) is inserted into the slot, the internal circuits may break and cause malfunctions.

When inserting a miniSD or microSD, use an adapter. Do not use an adapter which has metal parts other than the connectors exposed.

Do not insert a damaged SD memory card (e.g. warped, label peeled off) as it may not be ejected from the slot.

Do not try to force an SD memory card into the SD card slot as the card or this unit may be damaged.

When ejecting an SD memory card, press it and hold it until it clicks. It is dangerous for you to release your finger immediately after you press on the card as the card may shoot out of the slot and hit you in the face, etc. If the card shoots out of the slot, it may become lost.

iPod

To ensure proper operation, connect the dock connector cable from the iPod directly to this unit.

Firmly secure the iPod when driving. Do not let the iPod fall onto the floor, where it may become jammed under the brake or accelerator pedal.

About iPod settings

- When an iPod is connected, this unit changes the EQ (equalizer) setting of the iPod to off in order to optimize the acoustics. When you disconnect the iPod, the EQ returns to the original setting.
- You cannot set Repeat to off on the iPod when using this unit. Repeat is automatically changed to All when the iPod is connected to this unit.

Incompatible text saved on the iPod will not be displayed by the unit.

DualDiscs

DualDiscs are two-sided discs that have a recordable CD for audio on one side and a recordable DVD for video on the other.

Since the CD side of DualDiscs is not physically compatible with the general CD standard, it may not be possible to play the CD side with this unit.

Frequent loading and ejecting of a DualDisc may result in scratches on the disc. Serious scratches can lead to playback problems on this unit. In some cases, a DualDisc may become stuck in the disc loading slot and will not eject. To prevent this, we recommend you refrain from using DualDisc with this unit. Please refer to the information from the disc manufacturer for more detailed information about DualDiscs.

CAUTION

Do not leave the discs/external storage device (USB, SD) or iPod in places with high temperatures. 

Compressed audio compatibility (disc, USB, SD)

WMA

File extension: .wma

Bit rate: 48 kbps to 320 kbps (CBR), 48 kbps to 384 kbps (VBR)

Sampling frequency: 32 kHz, 44.1 kHz, 48 kHz

Windows Media Audio Professional, Lossless, Voice/DRM Stream/Stream with video: Not compatible

MP3

File extension: .mp3

Bit rate: 8 kbps to 320 kbps (CBR), VBR

Sampling frequency: 8 kHz to 48 kHz (32 kHz, 44.1 kHz, 48 kHz for emphasis)

Compatible ID3 tag version: 1.0, 1.1, 2.2, 2.3, 2.4 (ID3 tag Version 2.x is given priority over Version 1.x.)

M3u playlist: Not compatible

MP3i (MP3 interactive), mp3 PRO: Not compatible

WAV

File extension: .wav

Quantization bits: 8 and 16 (LPCM), 4 (MS ADPCM)

Sampling frequency: 16 kHz to 48 kHz (LPCM), 22.05 kHz and 44.1 kHz (MS ADPCM)

Additional information

AAC

Compatible format: AAC encoded by iTunes

File extension: .m4a

Sampling frequency: 11.025 kHz to 48 kHz

Transmission rate: 16 kbps to 320 kbps, VBR

Apple Lossless: Not compatible

AAC file bought from the iTunes Store (.m4p file extension): Not compatible

Supplemental information

Only the first 32 characters can be displayed as a file name (including the file extension) or a folder name.

This unit may not operate correctly depending on the application used to encode WMA files.

There may be a slight delay at the start of playback of audio files embedded with image data or audio files stored on a USB storage device that has numerous folder hierarchies.

Russian text to be displayed on this unit should be encoded in one of the following character sets:

- Unicode (UTF-8, UTF-16)
- A character set other than Unicode that is used in a Windows environment and is set to Russian in the multi-language setting

Disc

Playable folder hierarchy: up to eight tiers (A practical hierarchy is less than two tiers).

Playable folders: up to 99

Playable files: up to 999

File system: ISO 9660 Level 1 and 2, Romeo, Joliet

Multi-session playback: Compatible

Packet write data transfer: Not compatible

Regardless of the length of blank sections between the songs from the original recording, compressed audio discs play with a short pause between songs.

External storage device (USB, SD)

Playable folder hierarchy: up to eight tiers (A practical hierarchy is less than two tiers).

Playable folders: up to 1 500

Playable files: up to 15 000

Playback of copyright-protected files: Not compatible

Partitioned external storage device (USB, SD): Only the first playable partition can be played.

There may be a slight delay when starting playback of audio files on a USB storage device with numerous folder hierarchies.

SD memory card

There is no compatibility for Multi Media Cards (MMC).

Compatibility with all SD memory cards is not guaranteed.

This unit is not compatible with SD-Audio.

CAUTION

- Pioneer accepts no responsibility for data lost on USB memory/USB portable audio players/SD memory cards/SDHC memory cards, even if that data is lost while this unit is used.
- Pioneer cannot guarantee compatibility with all USB mass storage devices and assumes no responsibility for any loss of data on media players, smart phones, or other devices while using this product. 

Additional information

iPod compatibility

This unit supports only the following iPod models. Supported iPod software versions are shown below. Older versions may not be supported.

Made for

- iPod touch 4th generation (software version 4.1)
- iPod touch 3rd generation (software version 3.1.1)
- iPod touch 2nd generation (software version 2.1.1)
- iPod touch 1st generation (software version 1.1)
- iPod classic 160GB (software version 2.0.2)
- iPod classic 120GB (software version 2.0)
- iPod classic (software version 1.0)
- iPod with video (software version 1.2,3)
- iPod nano 6th generation (software version 1.0)
- iPod nano 5th generation (software version 1.0.1)
- iPod nano 4th generation (software version 1.0)
- iPod nano 3rd generation (software version 1.0)
- iPod nano 2nd generation (software version 1.1,3)
- iPod nano 1st generation (software version 1.3,1)
- iPhone 4 (software version 4.1)
- iPhone 3GS (software version 3.0)
- iPhone 3G (software version 2.0)
- iPhone (software version 1.1,1)

Depending on the generation or version of the iPod, some functions may not be available.

Operations may vary depending on the software version of iPod.

When using an iPod, an iPod Dock Connector to USB Cable is required.

A Pioneer CD-IU51 interface cable is also available. For details, consult your dealer.

About the file/format compatibility, refer to the iPod manuals.

Audiobook, Podcast: Compatible

CAUTION

Pioneer accepts no responsibility for data lost on the iPod, even if that data is lost while this unit is used. 

Sequence of audio files

The user cannot assign folder numbers and specify playback sequences with this unit.

Example of a hierarchy

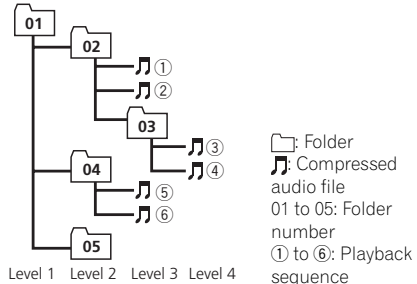

Disc

Folder selection sequence or other operation may differ depending on the encoding or writing software.

External storage device (USB, SD)

The playback sequence is the same as the recorded sequence in the external storage device (USB, SD).

To specify the playback sequence, the following method is recommended.

- ① Create a file name that includes numbers that specify the playback sequence (e.g., 001xxx.mp3 and 099yyy.mp3).
- ② Put those files into a folder.
- ③ Save the folder that contains the files to the external storage device (USB, SD).

However, depending on the system environment, you may not be able to specify the playback sequence.

For USB portable audio players, the sequence is different and depends on the player. 

Bluetooth profiles

In order to use Bluetooth wireless technology, devices must be able to interpret certain profiles. This unit is compatible with the following profiles.

- GAP (Generic Access Profile)
- SDP (Service Discovery Protocol)
- OPP (Object Push Profile)
- HFP (Hands Free Profile)
- HSP (Head Set Profile)

Additional information

- PBAP (Phone Book Access Profile)
- A2DP (Advanced Audio Distribution Profile)
- AVP (Audio/Video Profile)
- AVRCP (Audio/Video Remote Control Profile) 1.0

Copyright and trademark

Bluetooth

The *Bluetooth*[®] word mark and logos are registered trademarks owned by Bluetooth SIG, Inc. and any use of such marks by PIONEER CORPORATION is under license. Other trademarks and trade names are those of their respective owners.

iTunes

Apple and iTunes are trademarks of Apple Inc., registered in the U.S. and other countries.

MP3

Supply of this product only conveys a license for private, non-commercial use and does not convey a license nor imply any right to use this product in any commercial (i.e. revenue-generating) real time broadcasting (terrestrial, satellite, cable and/or any other media), broadcasting/streaming via internet, intranets and/or other networks or in other electronic content distribution systems, such as pay-audio or audio-on-demand applications. An independent license for such use is required. For details, please visit <http://www.mp3licensing.com>.

WMA

Windows Media is either a registered trademark or trademark of Microsoft Corporation in the United States and/or other countries. This product includes technology owned by Microsoft Corporation and cannot be used or distributed without a license from Microsoft Licensing, Inc.

SD memory card

SD Logo is a trademark of SD-3C, LLC. miniSD Logo is a trademark of SD-3C, LLC. microSD Logo is a trademark of SD-3C, LLC. SDHC Logo is a trademark of SD-3C, LLC.

iPod & iPhone

iPhone, iPod, iPod classic, iPod nano, and iPod touch are trademarks of Apple Inc., registered in the U.S. and other countries.

“Made for iPod” and “Made for iPhone” mean that an electronic accessory has been designed to connect specifically to iPod or iPhone, respectively, and has been certified by the developer to meet Apple performance standards. Apple is not responsible for the operation of this device or its compliance with safety and regulatory standards. Please note that the use of this accessory with iPod or iPhone may affect wireless performance.

Additional information

Specifications

General

Power source	14.4 V DC (10.8 V to 15.1 V allowable)
Grounding system	Negative type
Maximum current consumption	10.0 A
Dimensions (W × H × D):	
DIN	
Chassis	178 mm × 50 mm × 165 mm
Nose	188 mm × 58 mm × 17 mm
D	
Chassis	178 mm × 50 mm × 165 mm
Nose	170 mm × 46 mm × 17 mm
Weight	1.3 kg

Audio

Maximum power output	50 W × 4 50 W × 2/4Ω + 70 W × 1/2Ω (for subwoofer)
Continuous power output	22 W × 4 (50 Hz to 15 000 Hz, 5% THD, 4Ω load, both channels driven)
Load impedance	4Ω to 8Ω × 4 4Ω to 8Ω × 2 + 2Ω × 1
Preout maximum output level	4.0 V
Equalizer (5-Band Graphic Equalizer):	
Frequency	100 Hz/315 Hz/1.25 kHz/3.15 kHz/8 kHz
Gain	±12 dB
HPF:	
Frequency	50 Hz/63 Hz/80 Hz/100 Hz/125 Hz
Slope	-12 dB/oct
Subwoofer (mono):	
Frequency	50 Hz/63 Hz/80 Hz/100 Hz/125 Hz
Slope	-18 dB/oct
Gain	+6 dB to -24 dB
Phase	Normal/Reverse
Bass boost:	
Gain	+12 dB to 0 dB

CD player

System	Compact disc audio system
Usable discs	Compact disc
Signal-to-noise ratio	94 dB (1 kHz) (IEC-A network)
Number of channels	2 (stereo)
MP3 decoding format	MPEG-1 & 2 Audio Layer 3
WMA decoding format	Ver. 7, 7.1, 8, 9, 10, 11, 12 (2 ch audio) (Windows Media Player)
AAC decoding format	MPEG-4 AAC (iTunes encoded only) (.m4a) (Ver. 9.2 and earlier)

WAV signal format	Linear PCM & MS ADPCM (Non-compressed)
-------------------------	--

USB

USB standard specification	USB 2.0 full speed
Maximum current supply	1 A
USB Class	MSC (Mass Storage Class)
File system	FAT12, FAT16, FAT32
MP3 decoding format	MPEG-1 & 2 Audio Layer 3
WMA decoding format	Ver. 7, 7.1, 8, 9, 10, 11, 12 (2 ch audio) (Windows Media Player)
AAC decoding format	MPEG-4 AAC (iTunes encoded only) (.m4a) (Ver. 9.2 and earlier)
WAV signal format	Linear PCM & MS ADPCM (Non-compressed)

SD

Compatible physical format	Version 2.00
Maximum memory capacity	32 GB (for SD and SDHC)
File system	FAT12, FAT16, FAT32
MP3 decoding format	MPEG-1 & 2 Audio Layer 3
WMA decoding format	Ver. 7, 7.1, 8, 9, 10, 11, 12 (2 ch audio) (Windows Media Player)
AAC decoding format	MPEG-4 AAC (iTunes encoded only) (.m4a) (Ver. 9.2 and earlier)
WAV signal format	Linear PCM & MS ADPCM (Non-compressed)

FM tuner

Frequency range	87.5 MHz to 108.0 MHz
Usable sensitivity	9 dBf (0.8μV/75Ω mono, S/N: 30 dB)
Signal-to-noise ratio	72 dB (IEC-A network)

MW tuner

Frequency range	531 kHz to 1 602 kHz (9 kHz)
Usable sensitivity	25μV (S/N: 20 dB)
Signal-to-noise ratio	62 dB (IEC-A network)

LW tuner

Frequency range	153 kHz to 281 kHz
Usable sensitivity	28 μV (S/N: 20 dB)
Signal-to-noise ratio	62 dB (IEC-A network)

Bluetooth

Version	Bluetooth 3.0 certified
Output power	+4 dBm Maximum (Power class 2)

Note

Specifications and the design are subject to modifications without notice. ■

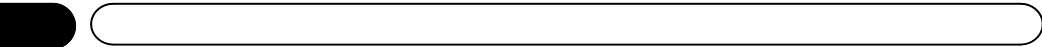

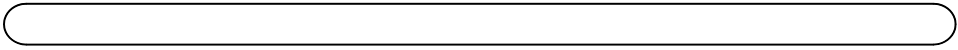

<http://www.pioneer.eu>

Visit **www.pioneer.co.uk** (or **www.pioneer.eu**) to register your product.

PIONEER CORPORATION

1-1, Shin-ogura, Saiwai-ku, Kawasaki-shi,
Kanagawa 212-0031, JAPAN

PIONEER ELECTRONICS (USA) INC.

P.O. Box 1540, Long Beach, California 90801-1540, U.S.A.
TEL: (800) 421-1404

PIONEER EUROPE NV

Haven 1087, Keetberglaan 1, B-9120 Melsele, Belgium/Belgique
TEL: (0) 3/570.05.11

PIONEER ELECTRONICS ASIACENTRE PTE. LTD.

253 Alexandra Road, #04-01, Singapore 159936
TEL: 65-6472-7555

PIONEER ELECTRONICS AUSTRALIA PTY. LTD.

5 Arco Lane, Heatherton, Victoria, 3202 Australia
TEL: (03) 9586-6300

PIONEER ELECTRONICS OF CANADA, INC.

340 Ferrier Street, Unit 2, Markham, Ontario L3R 2Z5, Canada
TEL: 1-877-283-5901
TEL: 905-479-4411

PIONEER ELECTRONICS DE MEXICO, S.A. de C.V.

Blvd.Manuel Avila Camacho 138 10 piso
Col.Lomas de Chapultepec, Mexico, D.F. 11000
TEL: 55-9178-4270

先鋒股份有限公司

台北市內湖區瑞光路407號8樓
電話：(02) 2657-3588

先鋒電子（香港）有限公司

香港九龍長沙灣道909號5樓
電話：(0852) 2848-6488

© 2011 PIONEER CORPORATION.
All rights reserved.