

Pioneer

Operation Manual

DVD RDS AV RECEIVER

AVH-X5500BT AVH-X3500DAB AVH-X2500BT AVH-X1500DVD



DX



Made for



iPod



iPhone



English

Thank you for purchasing this PIONEER product.

To ensure proper use, please read through this manual before using this product. It is especially important that you read and observe **WARNING**s and **CAUTION**s in this manual. *Please keep the manual in a safe and accessible place for future reference.*

01 Precautions

- IMPORTANT SAFEGUARDS 5
- To ensure safe driving 5
- To avoid battery exhaustion 6

02 Before you start

- About this unit 7
- DVD video disc region numbers 7
- About this manual 8
- If you experience problems 8
- Demo mode 8

03 What's what

- Head unit 9
- Home display 10
- Turning the source ON/OFF 10
- Selecting a source 11
- Adjusting the volume 11
- Optional remote control 11

04 Common operations

- Common operations for menu settings/
lists 12
- Operating the scroll icon and the scrubber
bar 12
- Activating the touch panel keys 13
- Using the rear view 13
- Using the rear monitor 13
- Using sound retriever 13
- Changing the wide-screen mode 14

05 Basic operations

- Adjusting the angle of the LCD panel and
ejecting media 15
- Setting the clock 15

06 DAB (Digital Audio Broadcasting)

- Digital Audio Broadcasting tuner
operations 16
- Storing and recalling stations 17

- Listening to a recent broadcast (time
shift) 17
- Selecting a Service Component 17
- Updating service list information 18

07 Tuner

- Tuner operations 19
- Storing and recalling stations 19
- Displaying radio text 19
- Storing and recalling radio text 20
- Storing the strongest stations 20
- Tuning in to strong signals 20
- Using iTunes tagging 20
- Receiving traffic announcements 21
- Receiving alarm broadcasts interrupting
regular broadcasts 21
- Using PTY functions 21
- Setting the FM tuning step 22
- RDS setting 22
- Switching Auto PI Seek 23

08 Disc (CD/DVD)

- Introducing movie operations 24
- Sound playback operations 26
- Switching the media file type 26
- Operating the DVD menu 26
- Random play (shuffle) 27
- Repeating playback 27
- Searching for the part you want to play 28
- Selecting audio output 28
- PBC playback 28
- Selecting tracks from the track title list 28
- Selecting files from the file name list 29
- Playing DivX® VOD content 29

09 iPod

- iPod control 30
- Moving images operations 30
- Sound playback operations 31

- Using this unit's iPod function from your iPod **32**
- Shuffle play **32**
- Repeating playback **33**
- Playing videos from your iPod **33**
- Browsing for a video/music on the iPod **33**
- Changing audiobook speed **34**
- Displaying lists related to the song currently playing (link search) **34**
- 10 AppRadio Mode**
 - AppRadio Mode operation **35**
 - Starting procedure **35**
 - Setting the Keyboard **36**
 - Setting the App sound mixing **36**
- 11 USB**
 - Moving images operations **37**
 - Sound playback operations **38**
 - Music browse mode **39**
 - Still image playback operations **39**
 - Switching the media file type **40**
 - Random play (shuffle) **40**
 - Repeating playback **40**
 - Selecting files from the file name list **40**
 - Displaying lists related to the song currently playing (link search) **40**
 - Playing DivX® VOD content **40**
 - Capture an image in JPEG files **40**
- 12 Bluetooth Audio**
 - Sound playback operations **42**
 - Setting up for Bluetooth audio **42**
 - Random play (shuffle) **43**
 - Repeating playback **43**
- 13 Using MIXTRAX**
 - MIXTRAX operation **44**
 - MIXTRAX EZ operation **44**
 - Starting MIXTRAX EZ operation **44**
 - Setting MIXTRAX mode **44**
 - Setting the effect **44**
- 14 Bluetooth telephone**
 - Bluetooth telephone operations **46**
 - Calling a number in the phone book **47**
 - Selecting a number by alphabet search mode **48**
 - Inverting names in phone book **48**
 - Using the missed, received and dialed call lists **48**
 - Setting automatic answering **49**
 - Adjusting the other party's listening volume **49**
 - Switching the ring tone **49**
 - Using the preset dial lists **49**
 - Making a call by entering phone number **50**
 - Setting the private mode **50**
 - Voice control **50**
- 15 Settings**
 - Menu operations **51**
- 16 Audio adjustments**
 - Using fader/balance adjustment **52**
 - Using balance adjustment **52**
 - Using the equalizer **52**
 - Using the auto-equalizer **53**
 - Using sonic center control **53**
 - Adjusting loudness **53**
 - Using subwoofer output **54**
 - Boosting the bass **54**
 - Using the high pass filter **54**
 - Adjusting source levels **54**
- 17 Setting up the video player**
 - Setting the subtitle language **56**
 - Setting the audio language **56**
 - Setting the menu language **56**
 - Setting the multi-angle DVD display **57**

- Setting the aspect ratio **57**
- Setting the slideshow interval **57**
- Setting parental lock **58**
- Setting the DivX subtitle file **59**
- Displaying the DivX® VOD registration code **59**
- Automatic playback of DVDs **59**

18 System settings

- Switching the auxiliary setting **60**
- Setting AV input **60**
- Setting the RGB Input **60**
- Setting the App sound mixing **60**
- Setting MIXTRAX mode **60**
- Changing the picture adjustment **60**
- Selecting the system language **61**
- Setting Demo Mode **62**
- Switching sound muting/attenuation **62**
- Setting the rear output and subwoofer controller **62**
- Using the keyboard **63**
- Setting the ever scroll **63**
- Setting the Bluetooth audio **63**
- Clearing Bluetooth memory **63**
- Updating Bluetooth connection software **63**
- Displaying the Bluetooth system version **64**
- Setting the Bluetooth safe mode **64**
- Setting the rear view camera (back up camera) **64**
- Auto EQ (auto-equalizing) **64**
- Selecting the video format **66**
- Setting the video signal **67**

19 Favorite menu

- Using the Favorite menu **68**

20 Bluetooth connection menu

- Bluetooth connection menu operations **69**

21 Theme menu

- Selecting the illumination color **71**
- Selecting the OSD (on-screen display) color **71**
- Selecting the background display **71**

22 Other functions

- Adjusting the response positions of the touch panels (Touch Panel Calibration) **72**
- Using an AUX source **72**
- Resetting the microprocessor **73**

Additional information

- Troubleshooting **74**
- Error messages **76**
- Understanding auto EQ error messages **80**
- Understanding messages **80**
- Indicator list **81**
- Handling guidelines **83**
- Compressed audio compatibility (USB) **85**
- Compressed audio compatibility (disc, USB) **85**
- iPod compatibility **86**
- Sequence of audio files **87**
- Using the display correctly **88**
- Bluetooth profiles **89**
- License, Warranty Disclaimer & Limitation of Liability **89**
- Language code chart for DVD **92**
- Specifications **93**

Precautions

IMPORTANT SAFEGUARDS

Please read all of these instructions regarding your display and retain them for future reference.

- 1 **Do not install the display where it may (i) obstruct the driver's vision, (ii) impair the performance of any of the vehicle's operating systems or safety features, including air bags, hazard lamp buttons or (iii) impair the driver's ability to safely operate the vehicle.**
- 2 **Do not operate this display if doing so in any way will divert your attention from the safe operation of your vehicle. Always observe safe driving rules and follow all existing traffic regulations. If you experience difficulty in operating the system or reading the display, park your vehicle in a safe location and make necessary adjustments.**
- 3 **Please remember to wear your seat belt at all times while operating your vehicle. If you are ever in an accident, your injuries can be considerably more severe if your seat belt is not properly buckled.**
- 4 **Never use headphones while driving.**
- 5 **To promote safety, certain functions are disabled unless the parking brake is on, and the vehicle is not in motion.**
- 6 **Never set the volume of your display so high that you cannot hear outside traffic and emergency vehicles.**

WARNING

Do not attempt to install or service your display by yourself. Installation or servicing of the display by persons without training and experience in electronic equipment and automotive accessories may be dangerous and could expose you to the risk of electric shock or other hazards. 

To ensure safe driving

WARNING

- **LIGHT GREEN LEAD AT POWER CONNECTOR IS DESIGNED TO DETECT PARKED STATUS AND MUST BE CONNECTED TO THE POWER SUPPLY SIDE OF THE PARKING BRAKE SWITCH. IMPROPER CONNECTION OR USE OF THIS LEAD MAY VIOLATE APPLICABLE LAW AND MAY RESULT IN SERIOUS INJURY OR DAMAGE.**
- To avoid the risk of damage and injury and the potential violation of applicable laws, this unit is not for use with a video screen that is visible to the driver.
- To avoid the risk of accident and the potential violation of applicable laws, no viewing of front seat video should ever occur while the vehicle is being driven.
- In some countries or states the viewing of images on a display inside a vehicle even by persons other than the driver may be illegal. Where such regulations apply, they must be obeyed and this unit's video features should not be used.

When you attempt to watch a video image while driving, the warning "**Viewing of front seat video source while driving is strictly prohibited.**" will appear on the front display. To watch a video image on the front display, park your vehicle in a safe place and apply the parking brake.

When using a display connected to rear monitor output

The rear monitor output on this unit (**V OUT**) is used to connect a rear display that allows passengers in the rear seats to watch videos.

WARNING

NEVER install the rear display in a location where the driver can watch videos while driving.

When using the rear view camera

With an optional rear view camera, this unit can be used as an aid to keep an eye on trailers, or when backing into a tight parking spot.



WARNING

- **SCREEN IMAGE MAY APPEAR REVERSED.**
- **USE INPUT ONLY FOR REVERSE OR MIRROR IMAGE REAR VIEW CAMERA. OTHER USE MAY RESULT IN INJURY OR DAMAGE.**



CAUTION

- The rear view camera function is to be used as an aid to keep an eye on trailers, or while backing up. Do not use for entertainment purposes.
- Please note that the edges of the rear view camera images may differ slightly according to whether full screen images are displayed when backing up, and whether the images are used for checking the rear when the vehicle is moving forward. 

To avoid battery exhaustion

Keep the vehicle engine running when using this unit to avoid draining the battery power.

- When no power is supplied to this unit, such as when the vehicle battery is being replaced, the microcomputer of this unit returns to its initial condition. We recommend that you transcribe the audio adjustment data.



WARNING

Do not use with vehicles that do not feature an ACC position. 

Before you start



If you want to dispose this product, do not mix it with general household waste. There is a separate collection system for used electronic products in accordance with legislation that requires proper treatment, recovery and recycling.

Private households in the member states of the EU, in Switzerland and Norway may return their used electronic products free of charge to designated collection facilities or to a retailer (if you purchase a similar new one).

For countries not mentioned above, please contact your local authorities for the correct method of disposal.

By doing so you will ensure that your disposed product undergoes the necessary treatment, recovery and recycling and thus prevent potential negative effects on the environment and human health.

About this unit

The tuner frequencies on this unit are allocated for use in Western Europe, Asia, the Middle East, Africa and Oceania. Use in other areas may result in poor reception. The RDS (radio data system) function only works in areas that broadcast RDS signals for FM stations.

CAUTION

This product is a class 1 laser product classified under the Safety of laser products, IEC 60825-1:2007, and contains a class 1M laser module. To ensure continued safety, do not remove any covers or attempt to gain access to the inside of the product. Refer all servicing to qualified personnel.

CLASS 1 LASER PRODUCT

CAUTION—CLASS 1M VISIBLE AND INVISIBLE LASER RADIATION WHEN OPEN, DO NOT VIEW DIRECTLY WITH OPTICAL INSTRUMENTS.

CAUTION

- Do not allow this unit to come into contact with liquids. Electrical shock could result. Also, damage to this unit, smoke, and overheating could result from contact with liquids.
- The Pioneer CarStereo-Pass is for use only in Germany.
- Always keep the volume low enough to hear outside sounds.
- Avoid exposure to moisture.
- If the battery is disconnected or discharged, any preset memory will be erased.

DVD video disc region numbers

Only DVD video discs with compatible region numbers can be played on this player. You can find the region number of the player on the bottom of this unit and in this manual (refer to *Specifications* on page 93).

About this manual

- This unit features a number of sophisticated functions to ensure superior reception and operation. All the functions have been designed for the easiest possible use, but many are not self-explanatory. This operation manual will help you benefit fully from this unit's potential and to maximize your listening enjoyment.
- This manual uses diagrams of actual screens to describe operations. However, the screens on some units may not match those shown in this manual depending on the model used.
- In the following instructions, USB memory sticks and USB audio players are collectively referred to as "USB storage device".
- In this manual, iPod and iPhone will be referred to as "iPod". 

If you experience problems

Should this product fail to operate properly, please contact your dealer or nearest authorized Pioneer Service Station. 

Demo mode

The feature demo automatically starts when you select **Off** for the source and continues while the ignition switch is set to ACC or ON. To cancel the feature demo, press and hold **MUTE**. Press and hold **MUTE** again to restart. Operating the feature demo while the car engine is turned off it may drain the battery power.

Important

The red lead (ACC) of this unit should be connected to the ignition on/off function. Failure to do so may result in battery drain. 

What's what

Head unit

AVH-X5500BT

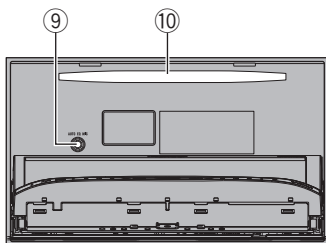
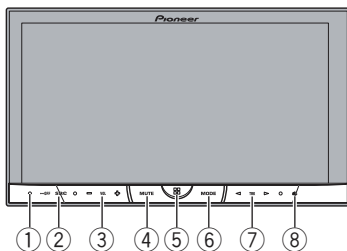

AVH-X3500DAB, AVH-X2500BT and AVH-X1500DVD

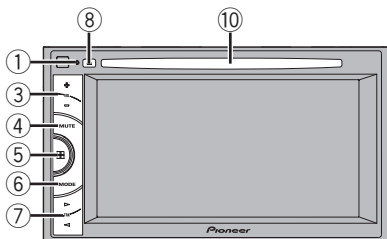

① RESET

For details refer to *Resetting the microprocessor* on page 73.

② SRC/OFF

③ +/- (VOLUME/VOL)

④ MUTE

Press to mute. Press again to unmute.

⑤ Home button

Displaying the home display.

The display returns to the Launcher screen while a 3rd-party application is being used in **AppRadio Mode**.

Double-clicking the icon on the Launcher screen returns the display to the home display.

⑥ MODE

Turning the information display off.

⑦ ◀/▶ (TRK)

⑧ ▲ (eject)

⑨ Auto EQ microphone input jack

Use to connect an auto EQ microphone.

⑩ Disc loading slot

⚠ CAUTION

Do not use unauthorized products.

Notes

- When the navigation system is connected, press **MODE** to switch to the navigation display. Press **MODE** and hold to turn the display off. Press **MODE** again to turn the display on.
- For details on how to operate a navigation system from this unit, refer to its operation manual.
- When an iPhone that is running an application that supports **AppRadio Mode** is connected, press **MODE** to switch to the application display. You can use the application by touching the display.
- About the way to connect the USB portable audio player/USB memory to this unit, refer to installation manual. 

Home display

Home display

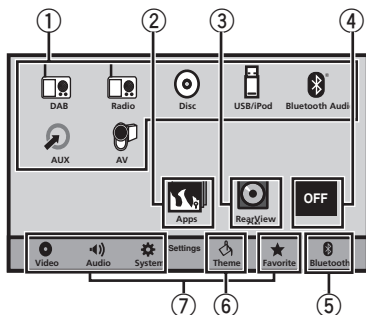

Source off display

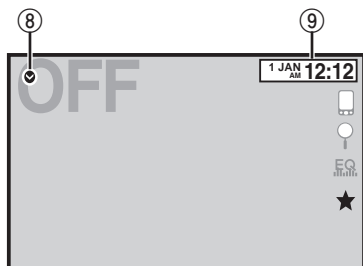

Source on display

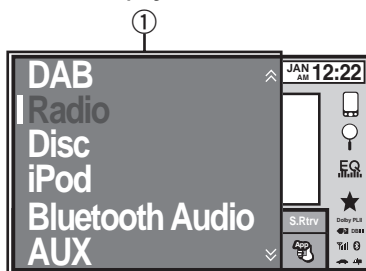

① Source icon

Selecting a favorite source.

When the source icon is not displayed, it can be displayed by pressing the home key or touching .

② Apps key

Switching to **AppRadio Mode**.

③ Rear view key

Displaying the rear view image.

For details refer to *Using the rear view* on page 13.

④ Source off key

Turning the source off.

⑤ Bluetooth key

Displaying the Bluetooth connection menu.

⑥ Theme key

Displaying the **Theme** menu.

⑦ Menu icon

Displaying the menu.

⑧ Source key

Displaying the source menu.

⑨ Clock key

Switching to clock adjustment display. .

Turning the source ON/OFF

(Function of AVH-X5500BT)

Turning the source on using the buttons
 ① Press **SRC/OFF** to turn the source on.

Turning the source off using the buttons
 ① Press **SRC/OFF** and hold until the source turns off.



What's what

Selecting a source

Available source modes

- **DAB** – Digital Audio Broadcasting tuner (AVH-X3500DAB)
- **Radio** – Radio tuner
- **Disc** – Built-in DVD and CD player
- **USB/iPod** – USB/iPod
- **Bluetooth Audio** – Built-in Bluetooth audio (AVH-X5500BT/AVH-X3500DAB/AVH-X2500BT)
- **AUX** – AUX
- **AV** – AV input

Selecting a source

- Using **SRC/OFF**
(Function of AVH-X5500BT)
 Press **SRC/OFF**.
- Using the touch panel keys on the home display
 Touch the source icon and then touch the desired source name.
 - When the source icon is not displayed, it can be displayed by touching the screen.
 - While operating the menu, you cannot select a source by touching the source icon.

Note

The **USB/iPod** icon will change as follows:

- **USB** is displayed when a USB storage device is connected to USB input.
- **iPod** is displayed when an iPod is connected to USB input.
- **USB/iPod** is displayed when no device is connected.
- **iPod** is not displayed when **RGB Input** is set to **iPhone (VGA adapter)**.
Refer to *Setting the RGB Input* on page 60.

Adjusting the volume

- Press **+/- (VOLUME/VOL)** to adjust the volume.

Optional remote control

The remote control CD-R33 is sold separately.

For details concerning operations, see the remote control manual.

Common operations for menu settings/lists

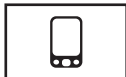

(Function of AVH-X5500BT/AVH-X3500DAB/AVH-X2500BT)
Starting the Bluetooth telephone menu.
For details refer to *Bluetooth telephone* on page 46.



Displaying the list menu.
Starting the search function.



Displaying the EQ (Audio function menu).



Displaying the Favorite menu.



Operating the scroll icon and the scrubber bar

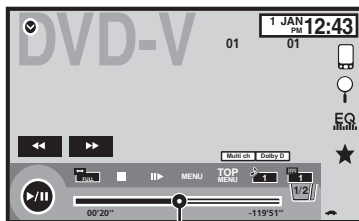
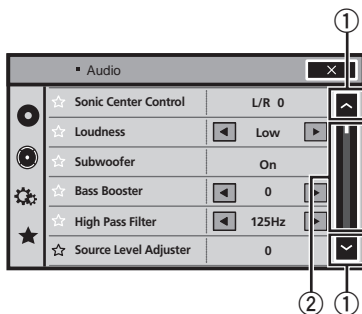

②

① Scroll icon

Appears when selectable items are hidden.

② Scrubber bar

Appears when items cannot be displayed on a single page only.

Viewing the hidden items

① Touch the scroll icon or drag the scrubber bar to view any hidden items.

- Also, you can drag the list to view any hidden items.

Specifying the playback point

① Drag the scrubber bar on the screen.
(Not available when the scrubber bar is grayed out.)



Common operations

Activating the touch panel keys

Touch panel keys

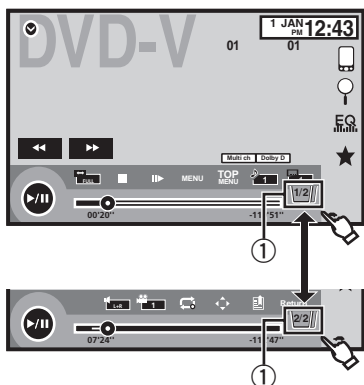

① Tab key

Switching the touch keys on the display.

Using the rear view

The below functions are available. Use of the rear view camera feature requires a rear view camera sold separately.

- Rear view camera
This unit can be setup to display the rear view image automatically when you move the shift lever to the **REVERSE (R)** position.
- Camera for rear view mode
The rear view can be turned on to display at all times.
The rear view camera needs to be set to a setting other than Off to turn on rear view mode.

For details about the settings, refer to *Setting the rear view camera (back up camera)* on page 64.

Using the rear view key to display the rear view

Displaying the rear view image by turning the rear view image on. When the rear view image is displayed, you can switch to the source display temporarily at this time. If you do not perform any operations within a few seconds, the display will return to the rear view image.

To turn off the rear view image, press the home button to return to the home display and then press this key again.



Using the rear monitor

Connecting a rear monitor, sold separately, to this unit allows images and videos to be viewed from the rear seats.

Notes

- Touch keys and operation screens do not display on the rear monitor.
- Images and video will continue to be displayed whether the vehicle is in motion or stopped.

Using sound retriever

S.Rtrv

Automatically enhances compressed audio and restores rich sound.

Off — ■ — ■■

- ■■ is more effective than ■.

Notes

- This function is enabled for playback on the sources listed below.
— CD-DA

- MP3/WMA/AAC/WAV files on USB storage devices
- MP3/WMA/AAC files on CD media
- iPod
- The sound retriever setting is turned Off when the MIXTRAX function is used in USB source mode.

Changing the wide-screen mode



Selecting the appropriate screen ratio for the playback video.

- The video image will appear coarser when viewed in **ZOOM** mode.
- This function is enabled for playback on the sources listed below.
 - **Disc:** DVD-V, Video-CD, DivX, MPEG-1, MPEG-2, MPEG-4, JPEG
 - **USB:** DivX, MPEG-1, MPEG-2, MPEG-4, JPEG
 - **iPod:** Video
 - **AV Input:** A/V data
 - **AUX:** A/V data

1 Display the screen mode.

2 Touch the desired wide mode setting.

FULL (full screen)

The 4:3 picture is enlarged in the horizontal direction only, granting viewers a 4:3 TV picture (normal picture) without any omissions.

ZOOM (zoom)

The 4:3 picture is enlarged in the same proportion both vertically and horizontally; ideal for a cinema sized picture (wide screen picture).

NORMAL (normal)

The 4:3 picture is displayed as is, granting viewers no sense of disparity as the proportions are the same as that of the normal picture.

Notes

- You cannot operate this function while driving.
- Different settings can be stored for each video source.
- When a video is viewed in a wide screen mode that does not match its original aspect ratio, it may appear different.
- Remember that using the wide mode feature of this system for commercial or public viewing purposes may constitute an infringement on the author's rights protected by the Copyright Law.

Basic operations

Adjusting the angle of the LCD panel and ejecting media

CAUTION

Keep hands and fingers clear of the unit when opening, closing, or adjusting the LCD panel. Be especially cautious of children's hands and fingers.

Adjusting the LCD panel angle

(Function of AVH-X5500BT)

- 1 Press **▲**(eject) to display the ejecting menu.
- 2 Adjust the LCD panel to an easily viewable angle.



Laying the panel down.



Returning the panel to the upright position.

- As the set angle is saved, the LCD panel will automatically be adjusted to the same position the next time the LCD panel is opened.

Ejecting a disc

(Function of AVH-X5500BT)

- 1 Press **▲**(eject) to display the ejecting menu.
- 2 Eject a disc.

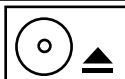

Ejecting a disc.

Ejecting a disc

(Function of AVH-X3500DAB/AVH-X2500BT/AVH-X1500DVD)

- Press **▲** to eject a disc. 

Setting the clock

- 1 Touch the **Clock** key.
The **Clock Adjustment** screen appears.
For details refer to **Home display** on page 10.
- 2 Select the item to set.
- 3 Touch **▲** or **▼** to set the correct date and time. 

Digital Audio Broadcasting tuner operations

(Function of AVH-X3500DAB)

To receive DAB signals, connect a DAB antenna (AN-DAB1) sold separately to the unit.

- High sound quality (nearly as high as for CDs, although it may be reduced in some cases in order to allow more services to be broadcast)
- Interference-free reception

Note

Some stations perform broadcast testing.

Touch panel keys

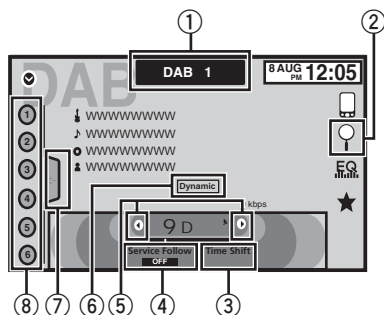

① Band key

Selecting a band (**DAB1**, **DAB2** or **DAB3**) by touching the icon. To enable this unit to memorize more Services, frequencies are stored in three bands, 1, 2 and 3. (Frequencies (Ensemble) that can be received are the same for 1, 2 and 3.)

② Search key

Displaying the service list mode.

③ Time shift key

Displaying the Time Shift information.

④ Service follow key

Turning service follow on or off with each touch of the button.

If the tuner cannot get good reception, the unit will automatically search for another ensemble that supports the same Service Component. If no alternative Service Component can be found or reception remains poor, this function will automatically switch to an identical FM broadcast.

⑤ Tuning key

Tuning up or down manually.

Touch and hold down for more than two seconds to skip stations. Seek tuning starts as soon as you release. Touch again to cancel seek tuning.

⑥ Dynamic key

Dynamic label provides character information concerning the service component you're currently listening to. You can scroll the displayed information.

Up to 128 characters of text can be displayed at a time.

If there are other pages before or after the current one, use the page up/page down keys to switch between pages.

⑦ List key



Displaying the preset channel list.

⑧ Preset channel key

Select a preset channel.

DAB (Digital Audio Broadcasting)

Basic operations

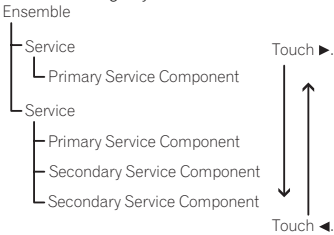
Switching preset channels using the buttons  Press ◀ or ▶ (TRK).
Seek tuning using the buttons  Press and hold ◀ or ▶ (TRK).
Manual tuning (step by step)  Touch the tuning keys.  <p>Some individual services in an ensemble may be further subdivided into Service Components. The main Service Component is called the Primary Service Component, and any auxiliary Service Components are called Secondary Service Components.</p>

Storing and recalling stations

You can easily store up to six stations for each band as presets.

- Six stations for each band can be stored in memory.
- Channels are stored and recalled on a broadcast station basis.

1 Display the preset channel list screen.

Refer to *Digital Audio Broadcasting tuner operations* on the previous page.

The preset channel list appears in the display.

2 Touch and hold down one of the preset tuning keys to store the selected frequency to the memory.

The selected radio station frequency has been stored in the memory.

3 Touch the appropriate preset tuning key to select the desired station.

Listening to a recent broadcast (time shift)

You can navigate through recent broadcasts from the selected Service Component.

1 Touch Time Shift to switch to time shift mode.

Touch Live to resume the live broadcast.

2 Drag the scrubber bar on the screen to adjust the playback point.

- Drag the scrubber to the left to skip back one minute.
- Drag the scrubber to the right to skip forward one minute.

This unit stores recent broadcasts to memory automatically. The memory capacity of this unit will vary depending on the bit rate of the Service Component used. The approximate memory capacity is five minutes for 192 kbps. Stored selections that are older than what can be stored in the memory will not be available.

Pausing

You can use the pause function to temporarily stop listening to a DAB.

1 Touch Time Shift to switch to time shift mode.

2 Touch Pause and Play to pause playback temporarily.

- If the duration that a selection is paused exceeds the length of the memory capacity, playback will resume from the beginning of the selection in memory. 

Selecting a Service Component

You can select a Service Component from the following service list.

1 Touch Search to switch to the service list mode.

2 Touch the desired service title to switch to the service from service list.

Once selected, the following Service Component functions can be adjusted.

SERVICE (service label)

You can select a Service Component from the list of all components.

Using alphabet search

- 1 Touch the alphabet search key.
Alphabet search mode is displayed.
- 2 Touch the first letter of the title of the Service Component you are looking for.
While searching, touch panel key operation is not available.
 - To refine the search with a different letter, touch **Cancel**.
- 3 Touch the title of the list that you want to receive a broadcast from the selected Service Component.

PROGRAM TYPE (PTY label)

You can select a Service Component from PTY information.

- 1 Touch to scroll to the desired PTY information and press it to select.
News&Info—Popular—Classics—Others
- 2 Touch to select a Service Component.

ENSEMBLE (ensemble label)

You can select a Service Component from the relevant ensemble.

- 1 Touch to scroll to the desired ensemble and press it to select.



Updating service list information

You can receive updates to the service list.

1 Touch Search to switch to the service list mode.

2 Touch List Update in the service list mode.

Tuner

Tuner operations

Touch panel keys

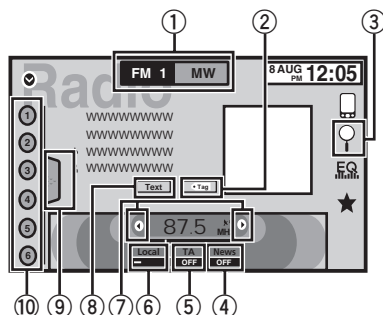

- ① **Band key**
Selecting a band (**FM1**, **FM2** or **FM3**) by touching the left icon. Switching to the **MW/LW** band by touching the right icon. The icon for the selected band is high-lighted.
- ② **Tag key**
Saving song information (tag) from the broadcasting station to your iPod.
- ③ **Search key**
Displaying the PTY information.
- ④ **News key**
Turning news program interruption on or off.
- ⑤ **TA key**
Turning TA (traffic announcement standby) on or off.
- ⑥ **Local key**
Setting the local seek level.
- ⑦ **Tuning key**
Tuning up or down manually.
Touch and hold down for more than two seconds to skip stations. Seek tuning starts as soon as you release. Touch again to cancel seek tuning.

- ⑧ **Text key**
Displaying radio text.
Storing and recalling radio text.
- ⑨ **List key**
Displaying the preset channel list.
- ⑩ **Preset channel key**
Selecting a preset channel.

Basic operations

Switching preset channels using the buttons

- ① Press ◀ or ▶ (**TRK**).

Seek tuning using the buttons

- ① Press and hold ◀ or ▶ (**TRK**).

Notes

- Listening MW/LW radio while an iPod is charged from this unit may generate noise. In this case, disconnect the iPod from this unit.
- Touch panel keys not listed under *Tuner operations* may appear on the display.
Refer to *Indicator list* on page 81.

Storing and recalling stations

You can easily store up to six stations for each band as presets.

- 1 Display the preset screen.**
Refer to *Tuner operations* on this page.
The preset screen appears in the display.
- 2 Touch and hold down one of the preset tuning keys to store the selected frequency to the memory.**
The selected radio station frequency has been stored in the memory.
- 3 Touch the appropriate preset tuning key to select the desired station.**

Displaying radio text

(Only available on FM stations)

Tuner

Storing the tagged information to your iPod

1 Connect your iPod.

When your iPod is connected to this unit, your iPod starts storing the tagged information automatically.

2 When completed, indicator turns off and the tagged information is stored on your iPod.

Receiving traffic announcements

(Only available on FM stations)

Regardless of the source you are listening to, you can receive traffic announcements automatically with TA (traffic announcement standby).

1 Tune in to a TP or enhanced other network's TP station.

 indicator lights up.

2 Turn Traffic announcement on.

Refer to *Tuner operations* on page 19.

- If the TA function is turned on when you are not tuned in to a TP or enhanced other network's TP station, the  indicator lights up dimly.

3 Press +/- (VOLUME/VOL) to adjust the TA volume when a traffic announcement begins.

The newly set volume is stored in the memory and will be recalled for subsequent traffic announcements.

4 Turn off the announcement while a traffic announcement is being received.

Refer to *Tuner operations* on page 19.

The tuner returns to the original source but remains in the TA function standby mode until the icon is touched again. 

Receiving alarm broadcasts interrupting regular broadcasts

(Only available on FM stations)

You can choose to receive the alarm broadcast automatically regardless of the source being listened to.

Reception of the previous program resumes once the alarm broadcast ends. 

Using PTY functions

(Only available on FM stations)

You can tune in to a station using PTY (program type) information.

Searching for an RDS station by PTY information

You can search for general types of broadcasting programs, such as those listed in the following section. Refer to the next page.

1 Touch the search key.

2 Touch or to select a program type.

There are four program types:

News&Info—Popular—Classics—Others

3 Touch Start to begin the search.

The unit searches for a station broadcasting that type of program. When a station is found, its program service name is displayed.

PTY (program type) information is listed in the following section. Refer to *PTY list* on the next page.

- To cancel the search, touch **Cancel**.
- The program of some stations may differ from that indicated by the transmitted PTY.
- If no station is broadcasting the type of program you searched for, **Not Found** is displayed for about two seconds and then the tuner returns to the original station.

Using news program interruption

When a news program is broadcast from a PTY code news station, the unit can switch from any station to the news broadcast station. When the news program ends, reception of the previous program resumes.

PTY list

News&Info (news and information)

News (News), **Affairs** (Current affairs), **Info** (Information), **Sport** (Sports), **Weather** (Weather), **Finance** (Finance)

Popular (popular)

Pop Mus (Popular music), **Rock Mus** (Rock music), **Easy Mus** (Easy listening), **Oth Mus** (Other music), **Jazz** (Jazz), **Country** (Country music), **Nat Mus** (National music), **Oldies** (Oldies music), **Folk Mus** (Folk music)

Classics (classics)

L.Class (Light classical), **Classic** (Classical)

Others (others)

Educate (Education), **Drama** (Drama), **Culture** (Culture), **Science** (Science), **Varied** (Varied), **Children** (Children's), **Social** (Social affairs), **Religion** (Religion), **Phone In** (Phone in), **Touring** (Travel), **Leisure** (Leisure), **Document** (Documentaries)



Setting the FM tuning step

Normally, the FM tuning step employed by seek tuning is 50 kHz. When AF or TA is on, the tuning step automatically changes to 100 kHz. It may be preferable to set the tuning step to 50 kHz when AF is on.

- The tuning step remains at 50 kHz during manual tuning.

1 Press the home button to switch to the home display.

2 Touch the system key to open the system menu.

3 Touch FM Step on the system menu to select the FM tuning step.

Touching **FM Step** will switch the FM tuning step between 50 kHz and 100 kHz. The selected FM tuning step will appear.

RDS setting

(Only available on FM stations)

Limiting stations to regional programming

When AF is used, the regional function limits the selection of stations to those broadcasting regional programs.

1 Press the home button to switch to the home display.

2 Touch the system key to open the system menu.

3 Touch RDS Setup on the system menu.

4 Touch Regional on the menu to turn the regional function on.

- To turn the regional function off, touch **Regional** again.

Selecting alternative frequencies

When the tuner cannot get a good reception, the unit automatically searches for a different station in the same network.

1 Press the home button to switch to the home display.

2 Touch the system key to open the system menu.

3 Touch RDS Setup on the system menu.

4 Touch Alternative FREQ to turn AF on.

- To turn AF off, touch **Alternative FREQ** again.

Notes

- Sound may be temporarily interrupted by another program during an AF frequency search.
- The AF feature can be set for **FM1**, **FM2**, and **FM3**.

Switching Auto PI Seek

The unit can automatically search for a different station with the same programming, even during preset recall.

1 Press the home button to switch to the home display.

2 Touch the system key to open the system menu.

3 Touch Auto PI on the system menu to turn Auto PI Seek on.

- To turn Auto PI Seek off, touch **Auto PI** again.

Introducing movie operations

You can use this unit to view DVD/DVD-R/ DVD-RW/CD/CD-R/CD-RW movie files.

Touch panel keys

DVD video

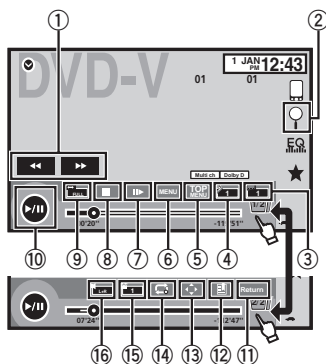

Video CD

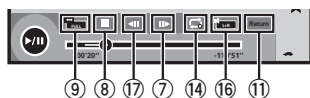

When playing a disc containing a mixture of various media file types

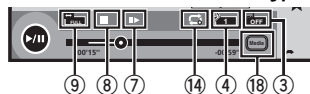

- ① **Fast forward key/Reverse key**
Fast forwarding or reversing
Touch to change the fast forward and reverse speed.
- ② **Search key**
Starting the search function.
- ③ **Switch subtitle language key**
With DVDs/DivX files featuring multi-subtitle recordings, you can switch between subtitle languages during playback.
- ④ **Switch audio language key**
With DVDs/DivX files that provides audio playback in different languages and different audio systems (Dolby Digital, DTS, etc.),

you can switch between languages/audio systems during playback. Depending on the setting, the video may not be played back with the audio system used to record the DVD.

- ⑤ **TOP MENU key**
Returning to the top menu during DVD playback.
- ⑥ **MENU key**
Displaying the DVD menu during DVD playback.
- ⑦ **Slow-motion playback key**
Moving the selection ahead one frame at a time during playback.
Touch and hold down the key for more than two seconds to slow down playback speed. Touching the key increases the playback speed over four incremental settings during slow motion playback from DVD video/Video CD.
- ⑧ **Stop key**
Stopping playback.
If you resume playback, playback will start from the point where you stopped. Touch the key again to stop playback completely.
- ⑨ **Screen mode key**
Changing the screen mode.
Refer to *Changing the wide-screen mode* on page 14.
- ⑩ **Pause and play key**
Pausing playback.
Returning to normal playback during paused, slow motion, or frame-by-frame playback.
- ⑪ **Return key**
Returning to the specified scene to which the DVD currently being played has been preprogrammed to return.
This function cannot be used if a specified scene has not been preprogrammed on the DVD disc.
- ⑫ **Bookmark key**
During playback, touch the point at which you want to resume playback the next time the disc is loaded.

Disc (CD/DVD)

- You can set one bookmark per DVD video. You can set up to five bookmarks total.
- To clear the bookmark on a disc, touch and hold the key during playback.
- The oldest bookmark is replaced by the new one.

13 Arrow key

Displaying arrow keys to operate the DVD menu.

14 Repeat key

Selecting the repeat range.

15 Viewing angle key

With DVDs featuring multi-angle (scenes shot from multiple angles) recordings, you can switch among viewing angles during playback.

16 Audio output key

Switching the audio output, when playing video discs recorded with LPCM audio.

17 Slow key

Speeding down the playback speed in four steps, during slow motion playback on DVD video/Video CD.

- There is no sound during slow motion playback.
- Images during slow motion playback may be unclear for some discs.
- Reverse slow motion playback is not available.

18 Media key

Switching between media file types to play on DVD/CD/USB.

Basic operations

Playing back videos

- 1 Insert the disc into the disc loading slot with the label side up.
Playback will automatically start.
 - If you are playing a DVD or Video CD, a menu may appear. Refer to *Operating the DVD menu* on the next page and *PBC playback* on page 28.
 - When the automatic playback function is on, the unit will skip the DVD menu and automatically start playback from the first chapter of the first title. Refer to *Automatic playback of DVDs* on page 59.
 - When the source icon is not displayed, it can be displayed by touching the screen.
 - If a message is displayed after loading a disc containing DivX VOD content, touch **Play**. Refer to *Playing DivX® VOD content* on page 29.

Ejecting a disc

- Refer to *Ejecting a disc* on page 15.

Selecting a chapter using the buttons

- 1 Press ◀ or ▶ (TRK).

Fast forwarding or reversing using the buttons

- 1 Press and hold ◀ or ▶ (TRK).
 - Fast forward/fast reverse may not always be possible on some discs. In such cases, normal playback will automatically resume.
 - The fast forward/fast reverse speed depends on the length of time you press and hold down ◀ or ▶ (TRK). This function is not available for Video CD.

Notes

- This DVD player can play back a DivX file recorded on CD-R/RW, DVD-R/RW, or MPEG-1/MPEG-2/MPEG-4. (Please see the following section for files that can be played back. Refer to *DivX video files* on page 84.)
- Do not insert anything other than a DVD-R/RW or CD-R/RW into the disc loading slot.
- Some operations may not be available while watching a media due to the programming of the disc. In such cases, the  icon appears on the screen.
- There may be touch panel keys not listed under *Introducing movie operations* on the previous page that appear on the screen. Refer to *Indicator list* on page 81.
- With some DVDs, switching between languages/audio systems may only be possible using a menu display.

- You can also switch between languages/audio systems using **Video Setup** menu. For details, refer to *Setting the audio language* on page 56.
- This unit will return to normal playback if you change the audio language during fast forward/fast reverse, pause or slow motion playback.
- With some DVDs, switching between subtitle languages may only be possible using a menu display.
- You can also switch between subtitle languages using **Video Setup** menu. For details, refer to *Setting the subtitle language* on page 56.
- This unit will return to normal playback if you change the subtitle language during fast forward/fast reverse, pause or slow motion playback.
- During playback of a scene shot from multiple angles, the angle icon is displayed. Use the **Video Setup** menu to turn the angle icon display on or off. For details, refer to *Setting the multi-angle DVD display* on page 57.
- You will return to normal playback if you change the viewing angle during fast forward/fast reverse, pause or slow motion playback.

Sound playback operations

You can use this unit to listen to DVD-R/DVD-RW/CD/CD-R/CD-RW sound files.

Touch panel keys

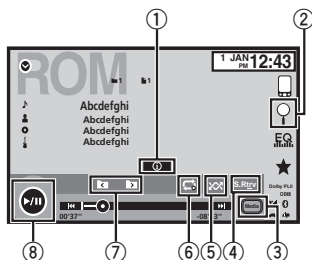

- ① **Information key**
Switching the text information to display on this unit when playing MP3/WMA/AAC files.

- ② **Search key**
Displaying a list of track titles/file names to select songs on a CD.
Displaying the file name list to select the files.
- ③ **Media key**
Switching between media file types on a DVD or CD.
- ④ **Sound retriever key**
Refer to *Using sound retriever* on page 13.
- ⑤ **Random key**
Playing songs in random order.
- ⑥ **Repeat key**
Selecting the repeat range.
- ⑦ **Previous folder key/Next folder key**
Selecting a folder.
- ⑧ **Pause and play key**
Pausing and starting playback.

Switching the media file type

When playing a digital media containing a mixture of various media file types, such as DivX, MPEG-1, MPEG-2, MPEG-4 and MP3, you can switch between media file types to play.

- **Touch Media to switch media file types.**
CD (audio data (CD-DA))—Music/ROM (compressed audio)—Video (DivX, MPEG-1, MPEG-2, MPEG-4 video files)

Note

Audio data (CD-DA) and JPEG picture files on DVD-R/RW/ROM cannot be played back on this unit.









Operating the DVD menu

(Function for DVD video)
Some DVDs allow you to make a selection from the disc contents using a menu.

Disc (CD/DVD)

Using the arrow keys

- 1 Display arrow keys to operate the DVD menu.
- 2 Select the desired menu item.

	Returning to the normal DVD video display.
	Displaying arrow keys.
	Selecting the desired menu item.
	
	
	
	Starting playback from the selected menu item.
	Operating the DVD menu by directly touching the menu item.
	Back to Previous display.

- When operating the DVD menu by directly touching the menu item, touch the icon to operate.
- Ways to display the menu will differ depending on the disc.
- Depending on the contents of the DVD disc, this function may not work properly. In such cases, use the touch panel keys to operate the DVD menu. 

Random play (shuffle)

- **Touch the random key.**
 - **Songs** – Play back videos/songs in the selected list in random order.
 - **Albums** – Play back videos/songs from a randomly selected album in order.
 - **Folder** – Play back songs/tracks in the selected folder in random order.
 - **Disc** – Play back songs/tracks in the selected disc in random order.
 - **On** – Play back files in random order within the repeat range, **Folder** and **Disc**.
 - **Off** – Cancel random play. 

Repeating playback

- **Touch the repeat key.**
 - **Disc** – Play through the current disc
 - **Chapter** – Repeat the current chapter
 - **Title** – Repeat the current title
 - **Track** – Repeat the current track
 - **File** – Repeat the current file
 - **Folder** – Repeat the current folder
 - **One** – Repeat just the current video/song

Notes

- This function cannot be operated during Video CD playback featuring PBC (playback control).
- If you perform chapter search, fast forward/reverse, frame-by-frame playback or slow motion playback, the repeat play will stop.
- When playing discs with compressed audio and audio data (CD-DA), playback is repeated within the type of data currently playing even if **Disc** is selected.
- If you select another folder during repeat play, the repeat play range changes to **Disc**.
- If you perform track search or fast forward/reverse during **File**, the repeat play range changes to **Folder**.
- If you perform title/chapter search or fast forward/reverse during **Chapter**, the repeat play is set to off automatically.
- If you perform track search or fast forward/reverse during **Track**, the repeat play range changes to **Disc**.
- When **Folder** is selected, it is not possible to play back a subfolder of that folder. 

Searching for the part you want to play

You can use the search function to find the part you want to play. For DVD videos, you can select **Title** (title), **Chapter** (chapter) or **10key** (numeric keypad). For video CDs, you can select **Track** (track) or **10key** (numeric keypad).

- Chapter search is not available when disc playback is stopped.
- This function cannot be operated during some DVD videos or Video CD playback featuring PBC (playback control).

1 Start the search function.

Refer to *Introducing movie operations* on page 24.

2 Touch the desired search option (e.g., Chapter).

3 Touch 0 to 9 to input the desired number.

- To cancel the entered numbers, touch **C**.

4 Start playback from the selected part.



Registering the numbers and starting playback.

Note

With discs featuring a menu, you can also use the DVD menu to make your selection.

Refer to *Introducing movie operations* on page 24.

Selecting audio output

When playing DVD video discs recorded with LPCM audio, you can switch the audio output. When playing video CDs, you can switch between stereo and monaural audio output.

- This function is not available when disc playback is stopped.
- **Touch the audio output key to switch audio output types.**
 - **L+R** – Left and right
 - **Left** – Left
 - **Right** – Right

- **Mix** – Mixing left and right

Note

You may not be able to select or use this function depending on the disc and the playback location.

PBC playback

(Function for Video CDs)

During playback of Video CDs featuring PBC (playback control), **PBC On** is displayed.

1 Start the search function.

Refer to *Introducing movie operations* on page 24.

2 Touch 10key to display the numeric keypad.

3 Touch 0 to 9 corresponding to a menu number.

4 Start playback from the selected part.



Registering the numbers and starting playback.

Notes

- You can display the menu by touching **Return** during PBC playback. For details, refer to the instructions provided with the disc.
- PBC playback of a Video CD cannot be canceled.
- During playback of Video CDs featuring PBC (playback control), you cannot select the repeat play range or use the search function.

Selecting tracks from the track title list

You can select tracks to playback using the track title list which is a list of the tracks recorded on a disc.

1 Display the track title list.

Refer to *Sound playback operations* on page 26.

2 Touch your favorite track title.

Playback begins.

Disc (CD/DVD)

Selecting files from the file name list

(Function for compressed audio/DivX/MPEG-1/MPEG-2/MPEG-4)

File name list is a list of file names (or folder names) from which you can select a file (or folder) to play back.

1 Touch the search key to display the file (or folder) name list.

2 Touch your favorite file (or folder) name.

- When you have selected a folder, a list of the names of the files (or the folders) in it can be viewed. Repeat this operation to select the desired file name.
- If folder **1** (ROOT) contains no files, playback commences with folder **2**.

Note

If part of the recorded information does not display, a scroll key appears on the right side of list. Touch the scroll key to scroll. 

Playing DivX® VOD content

Some DivX video on demand (VOD) content may only be playable a fixed number of times. When you load a disc containing this type of content, the number of times it has been played will be shown on-screen. You can then decide whether or not to play the disc.

- For DivX VOD content without this restriction, you can load the disc into your player and play the content as often as you like, with no message displayed.
- You can confirm the number of times that the content can be played by checking the message, **This DivX rental has used** **out of** **views..**

Important

- In order to play DivX VOD contents on this unit, you first need to register the unit with your DivX VOD contents provider. For details on your registration code, refer to *Displaying the DivX® VOD registration code* on page 59.
- DivX VOD content is protected by a DRM (Digital Rights Management) system. This re-

stricts playback of content to specific, registered devices.

● **If a message is displayed after loading a disc containing DivX VOD content, touch Play.**

Playback of the DivX VOD content will start.

- To skip to the next file, touch **Next Play**.
- If you do not want to play the DivX VOD content, touch **Stop**. 

iPod control

This manual applies to the following iPod models.

iPod with 30-pin connector

- iPod touch 4th generation
- iPod touch 3rd generation
- iPod touch 2nd generation
- iPod touch 1st generation
- iPod classic 160GB
- iPod classic 120GB
- iPod classic
- iPod with video
- iPod nano 6th generation
- iPod nano 5th generation
- iPod nano 4th generation
- iPod nano 3rd generation
- iPod nano 2nd generation
- iPod nano 1st generation
- iPhone 4S
- iPhone 4
- iPhone 3GS
- iPhone 3G
- iPhone

iPod with lightning connector

- iPod touch 5th generation
- iPod nano 7th generation
- iPhone 5

For iPod with lightning connector users

- Use the Lightning to USB Cable (Supplied with iPod/iPhone) when you use this function.
- For more details, refer to the installation manual.
- Functions related to iPod movie files are not available.
- If **AppRadio Mode** is used, the functions in this section cannot be used. Refer to **AppRadio Mode operation** on page 35. ■

Moving images operations

For iPod with 30-pin connector users

You can use the unit to view iPod movie files.

- Depending on your iPod, there may not be any output unless you use CD-IU201S/CD-IU201V (sold separately). Be sure to use CD-IU201S/CD-IU201V to connect your iPod.

For iPod with lightning connector users

- This function is not available.

Touch panel keys

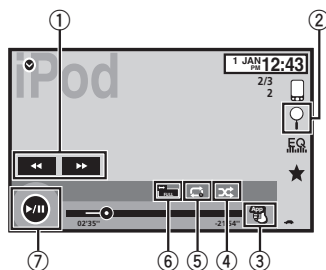

- ① **Fast forward key/Reverse key**
Fast forwarding or reversing
Touch to change the fast forward and reverse speed.
- ② **Search key**
Displaying iPod menus.
- ③ **iPod control mode key**
Conducting operation from your iPod and listening to it using your car's speakers.
- ④ **Shuffle key**
Playing the video on your iPod in a random order.
- ⑤ **Repeat key**
Selecting the repeat range.
- ⑥ **Screen mode key**
Changing the screen mode.
Refer to *Changing the wide-screen mode* on page 14.

iPod

⑦ Pause and play key

Pausing playback.

Returning to normal playback during paused, slow motion, or frame-by-frame playback.

Basic operations

Playing back videos

- ① Touch the search key to pull up the iPod menus.
- ② Select a movie to play.
Refer to *Playing videos from your iPod* on page 33.
 - When the source icon is not displayed, it can be displayed by touching the screen.
 - Disconnect headphones from the iPod before connecting it to this unit.
 - Depending on the iPod model and the amount of data stored in the iPod, it may take some time for playback to begin.
 - Use the touch panel keys to select the iPod after connecting it to this unit.
 - **No Device** is displayed when disconnecting the iPod.

Fast forwarding or reversing using the buttons

- ① Press and hold ◀ or ▶ (TRK).

Notes

- To ensure proper operation, connect the dock connector cable from the iPod directly to this unit.
- While the iPod is connected to this unit, the iPod cannot be turned on or off.
- Touch panel keys not listed under *Moving images operations* may appear on the display. Refer to *Indicator list* on page 81. 

Sound playback operations

You can use the unit to listen iPod sound files.

Note

The play time may not display correctly.

Touch panel keys

iPod audio (Control Audio)

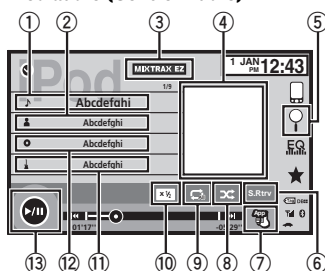

iPod audio (App Mode)



- ① **Song title**
Displaying the **Songs** list on the iPod.
- ② **Artist name**
Displaying the **Artists** list on the iPod.
- ③ **MIXTRAX EZ key**
Starting MIXTRAX EZ.
Refer to *MIXTRAX EZ operation* on page 44.
- ④ **Artwork**
Starting link search on your iPod when you touch the artwork display.
- ⑤ **Search key**
Displaying iPod menus.
- ⑥ **Sound retriever key**
Refer to *Using sound retriever* on page 13.
- ⑦ **iPod control mode key**
Conducting operation from your iPod and listening to it using your car's speakers.
- ⑧ **Shuffle key**
Playing songs on the iPod in random order.
- ⑨ **Repeat key**
Selecting the repeat range.

⑩ Change speed key

Changing the speed of audiobook playback on the iPod.

⑪ Genre

Displaying the **Genres** list on the iPod.

⑫ Album title

Displaying the **Albums** list on the iPod.

⑬ Pause and play key

Pausing and starting playback.

⑭ Unit operation key

Performing operations from this unit and listening to the music on your iPod using your car's speakers.

⑮ Screen mode key

Changing the screen mode.

Using this unit's iPod function from your iPod

You can listen to sound from applications on your iPod using the car's speakers when

App Mode is selected.

This function is not compatible with the following iPod models.

- iPod nano 1st generation
- iPod with video

Notes

- Video-related functions are not available to iPod with lightning connector users.
- While this function is in use, the iPod will not turn off even if the ignition key is turned off. Operate the iPod to turn off the power.

1 Switch the control mode to App Mode.

Refer to *Moving images operations* on page 30. Refer to *Sound playback operations* on the previous page.

2 Operate the connected iPod to select a video/song and play.**Notes**

- The following functions are still accessible from the unit even if the control mode is set to **App Mode**.

However, the operation will depend on your applications.

- Playing/pausing
- Fast forwarding/reversing
- Tracking up/down
- Moving to a chapter up/down

- **App Mode** is compatible with the following iPod models.

- iPod touch 4th generation
- iPod touch 3rd generation
- iPod touch 2nd generation
- iPod touch 1st generation
- iPod classic 160GB
- iPod classic 120GB
- iPod classic
- iPod nano 6th generation
- iPod nano 5th generation
- iPod nano 4th generation
- iPod nano 3rd generation
- iPod nano 2nd generation
- iPhone 4S
- iPhone 4
- iPhone 3GS
- iPhone 3G
- iPhone

Shuffle play

• Touch the shuffle key.

- **Songs** – Play back videos/songs in the selected list in random order.
- **Albums** – Play back videos/songs from a randomly selected album in order.
- **Folder** – Play back songs/tracks in the selected folder in random order.
- **On** – Play back files in random order within the repeat range.
- **Off** – Turn off shuffle play.

iPod

Repeating playback

- **Touch the repeat key.**
 - **One** – Repeat just the current video/song
 - **All** – Repeat all videos/songs in the selected list on the iPod 

Playing videos from your iPod

Videos can be played on this unit if an iPod with video capabilities is connected.

- This unit can play back “Movies”, “Music videos”, “Video Podcast” and “TV show” which are downloaded from the iTunes store.

Note

This function is not available to iPod with lightning connector users.

- 1 Touch Search to display iPod menus.**
Refer to *Moving images operations* on page 30.
- 2 Switch to iPod video mode.**

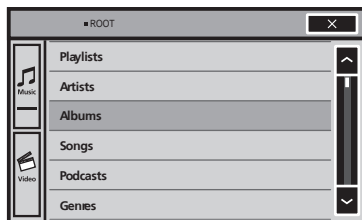

- If you want to switch to iPod video mode, touch the icon.



Switching to iPod video mode.

- 3 Play the video from the iPod.**

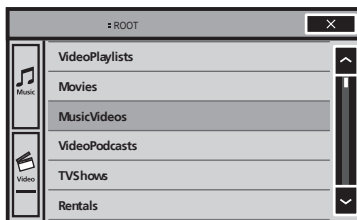

- If you want to switch to iPod music mode, touch the icon.



Switching to iPod music mode.

Browsing for a video/music on the iPod

To make operating and searching easy, operations to control an iPod with this unit are designed to be as similar to the iPod as possible.

Note

Video-related functions are not available to iPod with lightning connector users.

Searching for a video/music by category

- 1 Touch the search key to pull up the iPod menus.**

Refer to *Sound playback operations* on page 31.

- 2 Touch one of the categories in which you want to search for a video/music.**

- **Video Playlists** (video playlists)
- **Movies** (movies)
- **Music Videos** (music videos)
- **Video Podcasts** (video podcasts)
- **TV Shows** (TV shows)
- **Rentals** (rentals)
- **Playlists** (playlists)

- **Artists** (artists)
- **Albums** (albums)
- **Songs** (songs)
- **Podcasts** (podcasts)
- **Genres** (genres)
- **Composers** (composers)
- **Audiobooks** (audiobooks)

3 Touch the title of the list that you want to play.

Repeat this operation until you find the desired video/music.

Notes

- Depending on the generation or version of the iPod, some functions may not be available.
- You can play playlists created with the MusicSphere application. The application will be available on our website.
- Playlists that you created with the MusicSphere application are displayed in abbreviated form.

Searching the list by alphabet

1 Select a category.

Refer to *Searching for a video/music by category* on the previous page.

2 Switch to alphabet search mode.

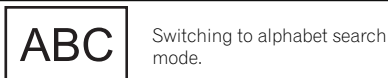

Alphabet search mode is displayed.

3 Touch the first letter of the title of the video/song you are looking for.

While searching, touch panel key operation is not available.

- To refine the search with a different letter, touch **Cancel**.

4 Touch the title of the list that you want to play.

Repeat this operation until you find the desired song/video. 

Changing audiobook speed

- **Touch the change speed key to change the speed.**

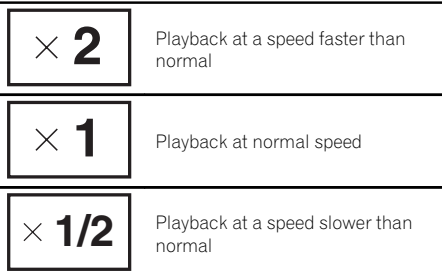

Displaying lists related to the song currently playing (link search)

Touch the artwork to open a list of the names of songs on the album currently playing.

Touch the name of the song you want to play to start playing that song.

Note

If part of the recorded information does not display, a scroll key appears on the right side of list. Touch the scroll key to scroll. 

AppRadio Mode

AppRadio Mode operation

This system can switch to the **AppRadio Mode**, which you can display and operate the application for iPhone on the screen.

In **AppRadio Mode**, you can operate applications with finger gestures such as tapping, dragging, scrolling or flicking on the screen of the system.

Install the AppRadio app on your iPhone.



WARNING

Certain uses of a smartphone may not be legal while driving in your jurisdiction, so you must be aware of and obey any such restrictions.

If in doubt as to a particular function, only perform it while the car is parked.

No feature should be used unless it is safe to do so under the driving conditions you are experiencing.



CAUTION

While driving, you cannot enter text on your iPod.

- Pioneer is not liable for any issues that may arise from incorrect or flawed app-based content.
- The content and functionality of the supported applications are the responsibility of the App providers.
- In **AppRadio Mode**, functionality through the product is limited while driving, with available functions determined by the App providers.
- Availability of **AppRadio Mode** functionality is determined by the App provider, and not determined by Pioneer.
- **AppRadio Mode** allows access to applications other than those listed (subject to limitations while driving), but the extent to which content can be used is determined by the App providers.

Important

- The only port that supports **AppRadio Mode** is USB input.

- When listening to music and sounds from application simultaneously, see the following section. Refer to *Setting the App sound mixing* on the next page.

Notes

- Applications operable by switching this system to **AppRadio Mode** are only those available for **AppRadio Mode**.
- Please check applications supported **AppRadio Mode** at <http://www.pioneer.eu/AppRadioMode>

iPhone compatibility

AppRadio Mode is compatible with the following iPod models.

- iPod touch 5th generation
- iPod touch 4th generation
- iPhone 5
- iPhone 4S
- iPhone 4 

Starting procedure

1 Install the AppRadio app on your iPhone.

2 After configuring RGB Input, connect the iPhone to this unit.

- **For iPod with lightning connector users** (Function of AVH-X5500BT/AVH-X3500DAB/AVH-X2500BT)
 - Set **RGB Input to iPhone (VGA adapter)**.
 - Use the CD-IV202AV (sold separately) and Lightning to VGA adapter (Apple Inc. products) (sold separately) when you use this function.
 - For more details, refer to the installation manual.
 - A Bluetooth connection is required for iPod with lightning connector. Refer to *Bluetooth connection menu* on page 69.
- **For iPod with 30-pin connector users**
 - Set **RGB Input to iPhone (CD-IU201S)**.
 - Use the CD-IU201S (sold separately) when you use this function.
 - For more details, refer to the installation manual.

3 Start an application available for AppRadio Mode from the iPhone.

An image of the application is displayed on the screen of this system.

- You can start an application available for **AppRadio Mode** also from a launcher application.

4 Press MODE.

Press the home button to switch to the home display and then touch the **Apps** key to start the launcher application.

5 Operate the application.

Setting the Keyboard

CAUTION

For your safety, the keyboard functionality is only available when the vehicle is stopped and the parking brake is engaged.

Depending on the application, you can input text on the display. In order to input text correctly using keyboard which appears on this unit, you need to set the language setting in this function.

When the **AppRadio Mode** is used, the language setting for the keyboard set for the function and the language setting for the iPhone keyboard need to be the same.

- Keyboard is available only in **AppRadio Mode**.

When you tap a text input area of an application on iPhone, a keyboard will be displayed on-screen. You can input the desired text directly from this system.

- The language preference for the keyboard of this system should be same as the setting on your iPhone.
If the settings for this product and the iPhone are different, you may not be able to enter characters properly.

1 Press the home button twice to switch from the AppRadio Mode display to the home display.

2 Touch the system key to open the system menu.

3 Touch Keyboard on the System menu to select desired language.

4 Touch the desired language.

French (French)—**German** (German)—**Greek** (Greek)—**Russian** (Russian)—**English** (US English)—**English (UK)** (UK English)—**Dutch** (Dutch)—**Italian** (Italian)—**Norwegian** (Norwegian)—**Swedish** (Swedish)—**Finnish** (Finnish)—**Spanish** (Spanish)—**Portuguese** (Portuguese)

5 Tap the text input area on the application screen of the iPhone.

Touch  to hide the keyboard.

Setting the App sound mixing

You cannot turn on or off Mixing when this unit is playing a song of iPod.

The sound of application during **AppRadio Mode** can be adjusted.

Enable this setting when you want to mix the App sound with the sound from a built-in source (such as the radio). The volume of the App sound can be selected from 3 levels.

This function is not available when **RGB Input** is set to **iPhone (VGA adapter)**.

Refer to *Setting the RGB Input* on page 60.

1 Press the home button twice to switch from the AppRadio Mode display to the home display.

2 Touch the system key to open the system menu.

3 Touch App sound mixing on the System menu to select desired setting.

OFF (off)—**Low** (low)—**Mid** (mid)—**High** (high)

USB

Moving images operations

You can use this unit to view USB storage device files.

Touch panel keys

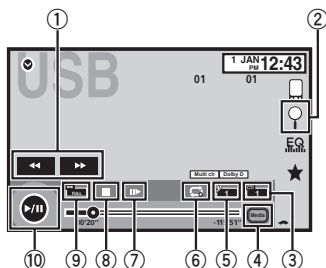

- ① **Fast forward key/Reverse key**
Fast forwarding or reversing
Touch to change the fast forward and reverse speed.
- ② **Search key**
Displaying USB menus.
- ③ **Switch subtitle language key**
With DivX files featuring multi-subtitle recordings, you can switch between subtitle languages during playback.
- ④ **Media key**
Switching between media file types to play on Music/Video/Photo.
- ⑤ **Switch audio language key**
With DivX files that provides audio playback in different languages and different audio systems (Dolby Digital, DTS, etc.), you can switch between languages/audio systems during playback.
- ⑥ **Repeat key**
Selecting the repeat range.
Refer to *Repeating playback* on page 40.
- ⑦ **Slow-motion playback key**
(Function for DivX file/MPEG-1/MPEG-2/MPEG-4)

Moving the selection ahead one frame at a time during playback.

Touch and hold down the key for more than two seconds to slow down playback speed.

- ⑧ **Stop key**
Stopping playback.
If you resume playback, playback will start from the point where you stopped. Touch the key again to stop playback completely.
- ⑨ **Screen mode key**
Changing the screen mode.
Refer to *Changing the wide-screen mode* on page 14.
- ⑩ **Pause and play key**
Pausing playback.
Returning to normal playback during paused, slow motion, or frame-by-frame playback.

Basic operations

Playing back videos

- ① Connect the USB device.
Playback will automatically start.
When the source icon is not displayed, it can be displayed by touching the screen.

Fast forwarding or reversing using the buttons

- ① Press and hold ◀ or ▶ (TRK).

Notes

- Touch panel keys not listed under *Moving images operations* may appear on the display. Refer to *Indicator list* on page 81.
- You can also switch between languages/audio systems using **Video Setup** menu. For details, refer to *Setting the audio language* on page 56.
- This unit will return to normal playback if you change the audio language during fast forward/fast reverse, pause or slow motion playback.
- You can also switch between subtitle languages using **Video Setup** menu. For details, refer to *Setting the subtitle language* on page 56.

- This unit will return to normal playback if you change the subtitle language during fast forward/fast reverse, pause or slow motion playback. 

Sound playback operations

You can use this unit to listen to USB audio files.

Notes

- The play time may not display correctly.
- When playing back files recorded as VBR (variable bit rate) files, the play time will not be correctly displayed if fast forward or reverse operations are used.
- To ensure proper operation, connect the dock connector cable from the iPod directly to this unit.
- While the iPod is connected to this unit, the iPod cannot be turned on or off.
- If the characters recorded on the disc are not compatible with this unit, those characters will not be displayed.
- Text information may not be correctly displayed depending on the recorded environment.
- Disconnect the USB portable audio player/USB memory when you are done using it.
- When you select **Speana** on *Selecting the background display* on page 71, the artwork is not displayed.

Touch panel keys

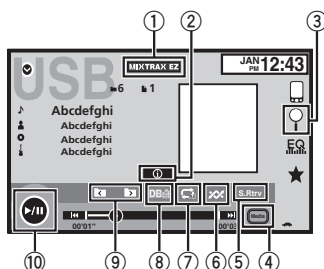

- ① **MIXTRAX EZ key**
Starting MIXTRAX EZ.
- ② **Information key**
Switching the text information to display on this unit when playing MP3/WMA/AAC/WAV files.
- ③ **Search key**
Displaying the file name list to select the files.
- ④ **Media key**
Switching between media file types to play on USB.
- ⑤ **Sound retriever key**
Refer to *Using sound retriever* on page 13.
- ⑥ **Random key**
Playing songs in random order.
- ⑦ **Repeat key**
Selecting the repeat range.
- ⑧ **DB key**
Creating a database that enables searches by artist name, genre, and other options. Refer to *Music browse mode* on the next page.
- ⑨ **Previous folder key/Next folder key**
Selecting a folder.
- ⑩ **Pause and play key**
Pausing and starting playback.

Basic operations

Playing back tracks

- ① Connect the USB device.
Playback will automatically start.
When the source icon is not displayed, it can be displayed by touching the screen.

Fast forwarding or reversing using the buttons

- ① Press and hold ◀ or ▶ (TRK).

Music browse mode

(Function for USB)

This unit creates an index in order to facilitate browsing for a song. You can search by the categories such as Albums and Artists.

CAUTION

- This function is not available when the USB storage device is locked.
- This function is not available when the free space of USB storage device is less than 5MB.
- While this unit creates an index, do not turn the unit off. It may cause loss of data on your USB storage device.
- If you switch to video or JPEG image display while a database is being created, or when a database could not be created, a message appears and database creation stops.

1 Touch DB to create a database in Music browse mode.

Refer to *Sound playback operations* on the previous page.

2 When "Save the Database to memory?" is displayed, touch "Yes".

Saving of the database is completed. If you do not save it, touch "No".

When the saving is completed, "**Database save to memory was completed.**" appears. Music browse mode will start.

3 Display a list and touch the tag key.

4 Select a file.

Still image playback operations

You can use this unit to view still images saved on a USB storage device.

Touch panel keys

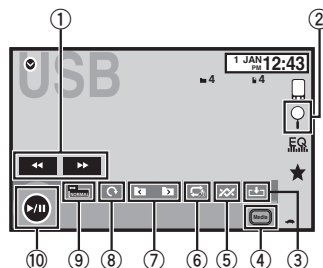

① Fast forward key/Reverse key

Selecting a picture.

② Search key

Displaying the file name list to select the files.

③ Capture key

Capturing an image in JPEG files.

④ Media key

Switching between media file types when there is more than one media file type saved to the USB device. This key does not appear if there is only one media file type saved to the USB device.

⑤ Random key

Playing files in a random order.

⑥ Repeat key

Selecting the repeat range.

⑦ Previous folder key/Next folder key

Selecting a folder.

⑧ Rotate key

Rotating the displayed picture 90° clockwise.

⑨ Screen mode key

Changing the screen mode.

Refer to *Changing the wide-screen mode* on page 14.

⑩ Pause and play key

Starting or pausing the slideshow.

Basic operations

Playing still images

- 1 Connect the USB device.
Playback will automatically start.
- When the source icon is not displayed, it can be displayed by touching the screen.

Selecting a file using the buttons

- 1 Press ◀ or ▶ (TRK).

Fast file searching

- 1 Press and hold ◀ or ▶ (TRK).
- You can search 10 JPEG files at a time.
If there are fewer than 10 files, the search will cover the first or last file.

Notes

- Files are played back in file number order and folders are skipped if they contain no files. (If folder **1** (ROOT) contains no files, playback commences with folder **2**.)
- Touch panel keys not listed under *Still image playback operations* may appear on the display.
Refer to *Indicator list* on page 81. 

Switching the media file type

- **Touch Media to switch between media file types.** 

Random play (shuffle)

- **Touch the random key.**
 - **On** – Play back files in random order within the repeat range, **Folder** and **Media**.
 - **Off** – Cancel random play. 

Repeating playback

- **Touch the repeat key.**
 - **Folder** – Repeat the current folder
 - **All** – Repeat all files
 - When **Folder** is selected, it is not possible to play back a subfolder of that folder.

- If you select USB source, the repeat play range changes to **All**. 

Selecting files from the file name list

(Function for compressed audio/DivX/MPEG-1/MPEG-2/MPEG-4)

Operation is the same as that for Disc.

Refer to *Selecting files from the file name list* on page 29. 

Displaying lists related to the song currently playing (link search)

Touch the artwork to open a list of the names of songs on the album currently playing.

Touch the name of the song you want to play to start playing that song.

Notes

- If part of the recorded information does not display, a scroll key appears on the right side of list. Touch the scroll key to scroll.
- This function is available for USB devices in Music browse mode. 

Playing DivX® VOD content

Operation is the same as that for Disc.

Refer to *Playing DivX® VOD content* on page 29. 

Capture an image in JPEG files

You can capture image data and use it as wallpaper. Images can be stored and recalled easily in this unit.

- Only one image can be stored on this unit.
Old image is overwritten with the new one.

- 1 Touch ►/|| to pause the slide show when the desired image is displayed.
- 2 Touch Capture to capture the desired image.
- 3 When “Do you save this image?” is displayed, touch Yes.

While storing the image to this unit, “Saving the image. Don’t switch off the battery.” is displayed. When the process is finished, “Image saved.” is displayed.

- To cancel the storage process, touch No.

Sound playback operations

(Function of AVH-X5500BT/AVH-X3500DAB/AVH-X2500BT)

You can use this unit to listen to Bluetooth audio files.

Notes

- Depending on the Bluetooth audio player connected to this unit, the available operations will be limited to the following two levels:
 - A2DP profile (Advanced Audio Distribution Profile): You can only playback songs on your audio player.
 - AVRCP profile (Audio/Video Remote Control Profile): You can perform playback, pause playback, select songs, etc.
- As there is a wide variety of Bluetooth audio players available on the market, operations available with specific models may vary extensively. When attempting to run a Bluetooth audio player using this unit, refer to the instruction manual that came with the player as well as to this manual for assistance.
- As the signal from your cellular phone may cause noise, avoid using it when you are listening to songs on your Bluetooth audio player.
- The sound from a Bluetooth audio player connected to this unit will be muted while a call is in progress on a cellular phone connected to this unit via Bluetooth wireless technology.
- The play time may not display correctly.
- Depending on the type of Bluetooth audio player you have connected to this unit, operation and information display may not be available for some functions.

Touch panel keys

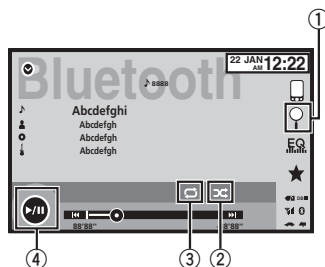

- Search key**
Displaying the file name list to select the files.
- Random key**
Playing songs in random order.
- Repeat key**
Selecting the repeat range.
- Pause and play key**
Pausing and starting playback.

Setting up for Bluetooth audio

Before you can use the Bluetooth audio function you must establish a Bluetooth wireless connection between the unit and your Bluetooth audio player.

- Connection**
First, you need to connect a Bluetooth audio to this unit.
For detailed instructions on connecting your Bluetooth audio to this unit via Bluetooth wireless technology, refer to *Bluetooth connection menu* on page 69.

Notes

- When playing back files recorded as VBR (variable bit rate) files, the play time will not be correctly displayed if fast forward or reverse operations are used.

Bluetooth Audio

- To ensure proper operation, connect the dock connector cable from the iPod directly to this unit.
- While the iPod is connected to this unit, the iPod cannot be turned on or off.
- If the characters recorded on the disc are not compatible with this unit, those characters will not be displayed.
- Text information may not be correctly displayed depending on the recorded environment.

Random play (shuffle)

- **Touch the random key.**
 - **On** – Play back files in random order.
 - **Off** – Cancel random play.

Repeating playback

- **Touch the repeat key.**
 - **One** – Repeat the current song only
 - **All** – Repeat all songs

MIXTRAX operation

MIXTRAX is original technology for creating non-stop mixes of selections from your audio library, complete with DJ effects that make them sound as if a DJ is right there with you playing the music.

MIXTRAX EZ operation

You can use this unit to play iPod/USB audio files.

MIXTRAX EZ is used to add a variety of sound effects between songs for arranging the pauses between songs. It allows you to enjoy listening to music non-stop.

- This function is only available when a file on a USB storage device or a song on an iPod is being played.
- This function is not available when the control mode is set to **App Mode**.
- Depending on the file/song, sound effects may not be available.
- Depending on the file/song, non-stop playback may not be available.

Starting MIXTRAX EZ operation

- Touch MIXTRAX EZ.

Setting MIXTRAX mode

Turn on this function to play back audio files using MIXTRAX.

- 1 Press the home button to switch to the home display.
- 2 Touch the system key to open the system menu.
- 3 Touch MIXTRAX Setup on the system menu.

MIXTRAX setting items are displayed.

- **Short Playback Mode** – When turned on, select an audio track playback length. When this mode is turned off, the audio track will play all the way to the end.

60s (60 sec.)—**90s** (90 sec.)—**120s** (120 sec.)—**150s** (150 sec.)—**180s** (180 sec.)—**Random** (random)—**Off** (off)

When **Random** is selected, the playback time varies between 60 s, 90 s, 120 s, 150 s, and 180 s selected at random when the playback song changes.

- **Display Effect** – When **Display Effect** is set to on, the artwork display can be moved according to the music type.
- **Cut-In Effect** – When **Cut-In Effect** is set to on, sound effects will play between tracks.
- **Effect Setting** – Use **Effect Setting** to set up the sound effect you want to insert between tracks.

Setting the effect

You can change the settings for fixed sounds and sound effects.

There are six different fixed sounds available that can be inserted for playback between tracks.

The sound effects are used as effects to signal the end of a song being played and the beginning of the next song in series.

The fixed sounds and sound effects are set as combinations as MIXTRAX sounds.

Fixed sounds

- **Phaser** – A fixed sound that sounds like surging waves.
- **Roll** – A fixed sound that repeats playback of a certain sound.
- **Turntable** – A fixed sound that mimics DJ scratching.
- **Flanger2** – A rushing sound that mimics that rising and falling sounds of a jet engine.
- **Reverb** – A fixed sound effect that creates a reverberation effect.
- **Echo2** – A fixed sound effect that creates an echoing effect.

Using MIXTRAX

Sound effects

- **Cross Fade** – A sound effect that creates a fade in and fade out effect between songs.
- **Flanger1** – A rushing sound that mimics that rising and falling sounds of a jet engine.
- **Echo1** – A sound effect that creates an echoing effect.
- **Loop** – A sound effect that repeats playback of one section of a song track.

Setting sounds and sound effects as presets using the preset key

The **Standard** and **Simple** sound effects are set already as default presets.

- **Touch Standard or Simple to check the settings.**

The registered preset sound effect for the key that was touched is set as a preset.

Registering sounds and sound effects as presets

Registers a desired combination of sounds and sound effects to **Custom**.

Touch **Custom** to easily set the desired sound or sound effect.

1 Touch Custom.

2 Add a check mark to the desired sound effect by touching the option.

The marked sound effect is registered as a preset in **Custom**.

Notes

- If a sound effect is touched in the selection screen for **Standard** or **Simple**, the **Custom** screen is automatically displayed and the sound effect is registered to **Custom**.
- You can listen to fixed sounds to hear examples by touching the speaker icon. 

Bluetooth telephone operations

(Function of AVH-X5500BT/AVH-X3500DAB/AVH-X2500BT)

You can use Bluetooth telephone.

Important

- Leaving the unit on standby to connect to your phone via Bluetooth while the engine is not running can drain the battery.
- Advanced operations that require attention such as dialing numbers on the monitor, etc., are prohibited while driving. Park your vehicle in a safe place when using these advanced operations.
- Bluetooth connection menu cannot be selected while driving.
- Operations available may be limited depending on the cellular phone connected to this unit.
- Be sure to park your vehicle in a safe place and apply the parking brake when performing this operation.
- If you are unable to complete the connection using this unit, use the device to connect to the unit.
- If you connect more than one device at a time, connected device may not operate properly. Connecting one device at a time is recommended.

Touch panel keys

Telephone standby display

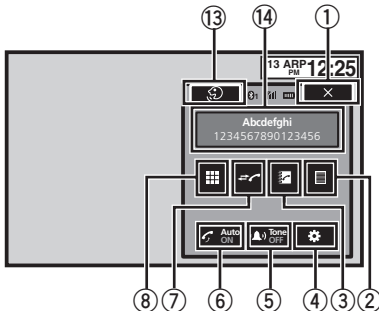

When switching to the entering phone number mode

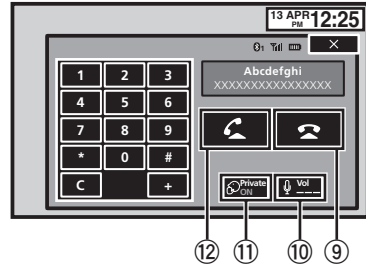

- ① **Close key**
Display is closed.
- ② **Preset dial key**
Displaying the preset dial screen.
- ③ **Phone book key**
Switching to the phone book mode.
- ④ **Setting key**
Displaying the Bluetooth connection menu.
- ⑤ **Tone key**
Turning the ring tone for incoming calls on or off.
- ⑥ **Auto-answer key**
Turning automatic answering on or off.
- ⑦ **History key**
Switching to the missed, received and dialed call lists.
- ⑧ **Key pad key**
Switching the mode to enter the phone number directly.
- ⑨ **On-hook key**
Ending a call.
Rejecting an incoming call.
Canceling call waiting.
- ⑩ **Volume key**
Adjusting the other party's listening volume.
- ⑪ **Private mode key**
Turning private mode on or off.

Bluetooth telephone

⑫ Off-hook key

- Accepting an incoming call.
- Making a phone call, when selecting a phone number.
- Switching between callers on hold.

⑬ Voice control key

Notes

- Private mode can only be operated while you are talking on the phone.
- To end the call, both you and the other caller must hang up your phones.
- Touch panel keys not listed under *Bluetooth telephone operations* may appear on the display.
Refer to *Indicator list* on page 81.

Text information

⑭ Incoming call notice

- Indicates that an incoming call has been received and has not been checked yet.
 - Not displayed for calls made when your cellular phone is disconnected from this unit.

Setting up for hands-free phoning

Before you can use the hands-free phoning function you must set up the unit for use with your cellular phone. This entails establishing a Bluetooth wireless connection between this unit and your phone, registering your phone with this unit, and adjusting the volume level.

① Connection

First, you need to connect a Bluetooth telephone to this unit.

For detailed instructions on connecting your phone to this unit via Bluetooth wireless technology, refer to *Pairing from this unit* on page 69.

② Volume adjustment

Adjust the earpiece volume of your cellular phone to your preference. The unit will record the adjusted volume level as the default setting.

Notes

- The volume of the caller's voice and ring tone may vary depending on the type of cellular phone.
- If there is a large volume difference between the ring tone and caller's voice, the overall volume level may become unstable.
- Make sure to adjust the volume to a proper level before disconnecting the cellular phone from the unit. If the volume is muted (zero level) on your cellular phone, the volume level of your cellular phone remains muted even after the cellular phone is disconnected.

Calling a number in the phone book

The contacts on your phone will normally be transferred automatically when the phone is connected. If it is not, use your phone menu to transfer the contacts. The visibility of this unit should be on when you use the phone menu. Refer to *Switching visible unit* on page 70. After finding the number you want to call in the phone book, you can select the entry and make the call.

1 Touch the phone book key to switch to the phone book mode.

2 Select the phone number list.

The detailed phone number list of the selected entry is displayed.

3 Select the phone number.

- If you want to store the phone number, touch and hold the list.

4 Touch the off-hook key to make the call.

5 Touch the on-hook key to end the call.

Bluetooth telephone

Note

The contacts on your phone will normally be transferred automatically when the phone is connected. If it is not, use your phone menu to transfer the contacts. The visibility of this unit should be on when you use the phone menu. Refer to *Switching visible unit* on page 70. 

Selecting a number by alphabet search mode

If a lot of numbers are registered in the phone book, you can search for the phone number by alphabet search mode.

1 Touch the phone book key to switch to the phone book mode.

2 Touch ABC to switch to alphabet search mode.

3 Touch the first letter of the entry you are looking for.

The Phone Book entries starting with that letter (e.g. "Ben", "Brian" and "Burt" when "B" is selected) will be displayed.

- If you want to change the character to Russian, touch the icon. To return to English, touch the icon again.



Changing the character to Russian.

- The order of the first name and last name may be different from that of the cellular phone.

4 Touch the list to display the phone number list of the selected entry.

- If several phone numbers are included in an entry, select one by touching the list.
- If you want to switch to the call history list, touch the icon.



Switching to the call history list.

5 Touch the off-hook key to make the call.

6 Touch the on-hook key to end the call. 

Inverting names in phone book

When your cellular phone is connected to this unit, the first and last names of your contacts may be registered to the phone book in reverse order. You can use this function to change the order back.

(Inverting the names in the phone book)

1 Touch the phone book key to switch to the phone book mode.

2 Invert names in phone books.



Inverting names in phone books.

3 "Would you like to invert all names?" appears. Touch Yes to continue.

While the names are inverted,  is displayed.

- If the inversion fails, "**Invert Name Error**" appears. In such cases, try again from the beginning.

Note

Inverting the names of your contacts from this unit does not affect the data on your Bluetooth device. 

Using the missed, received and dialed call lists

The 80 most recent calls dialed, received, and missed are stored in the memory. You can browse them and call numbers from these lists.

Bluetooth telephone

1 Touch the history key to display the call history list.

2 Select Missed Calls, Dialed Calls or Received Calls.



Displaying the received call list.



Displaying the dialed call list.



Displaying the missed call list.

3 Touch the list number to select a phone number.

Name and phone number are displayed in the detailed list.

- If you want to store the phone number, touch and hold the list.

4 Touch the off-hook key to make the call.

5 Touch the on-hook key to end the call. 

Setting automatic answering

If this function is on, this unit automatically answers all incoming calls.

● **Touch the auto-answer key to turn automatic answering on or off.** 

Adjusting the other party's listening volume

To maintain the good sound quality, this unit can adjust the other party's listening volume. If the volume is not loud enough for the other party, use this function.

● **Touch the volume key to select Far-End VOL.**

1—2—3

- This function can be performed even while talking on the phone.
- Settings can be stored for each device. 

Switching the ring tone

You can select whether or not to use this unit's ring tone. If this function is set to on, the ring tone for this unit will sound.

1 Connect your cellular phone to this unit.

2 Touch the tone key to turn the ring tone on or off. 

Using the preset dial lists

You can easily store up to six phone numbers as presets.

1 Touch the preset dial key to display the preset screen.

2 Touch one of the phone numbers to select.

- If you want to delete a preset phone number, touch and hold the phone number you wish to delete.

3 Touch the off-hook key to make the call.

4 Touch the on-hook key to end the call. 

Making a call by entering phone number



Important

Be sure to park your vehicle in a safe place and apply the parking brake when performing this operation.

1 Touch the key pad key to start entering the phone number.

2 Touch the number icons to input the numbers.

- Up to 24 digits can be entered.

3 Touch the off-hook key to make the call.

4 Touch the on-hook key to end the call.

Note

Entering phone number mode cannot be operated unless a Bluetooth telephone is connected to this unit. 

Setting the private mode

During a conversation, you can switch to private mode (talk directly on your cellular phone).

● **Touch the private mode key to turn private mode on or off.** 

Voice control

If your cellular phone is equipped with the voice control feature, you can use voice commands to make calls, for example.

- Operation varies depending on the type of cellular phone. Refer to the instruction manual that came with your cellular phone for detailed instructions.
- For details on cellular phone models that are compatible with this feature, refer to the information on our website.

1 Touch the voice control key.

The display switches to the voice control screen.

You can also switch to the voice control screen by pressing and holding down the home button while the source is on.

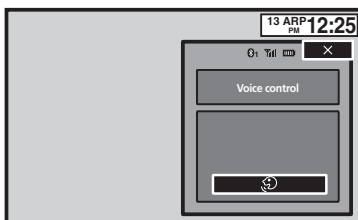

2 Start voice control.



Indicates that continuous calls can be made uninterrupted.



Indicates that the display is closed.

Notes

- In order for your voice commands to be recognized and interpreted correctly, ensure that conditions are suitable for recognition.
- Please note that wind blowing through the vehicle windows and noise coming from outside the vehicle can interfere with voice command operation.
- For optimum pick-up, the microphone should be placed directly in front of the driver at a suitable distance.
- Speaking too soon after the start of the command may cause voice recognition to fail.
- Speak slowly, deliberately, and clearly. 

Settings

Menu operations

Touch panel keys

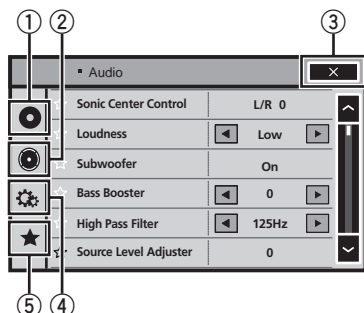

2 Touch any of the following touch panel keys to select the menu to be adjusted.



① Video setup key

Refer to *Setting up the video player* on page 56.

② Audio function key

Refer to *Audio adjustments* on the next page.

③ Close key

Returning to the current source display.

④ System key

Refer to *System settings* on page 60.

⑤ Favorite key

You can choose menus within each menu (Audio function menu, etc.) and register them to this favorite menu.

Refer to *Favorite menu* on page 68.

Notes

- You can display the **Video Setup** menu when a **Disc** or **USB** source is selected.
- If you start the **Video Setup** menu, playback is stopped.
- You cannot display the Audio function menu when the mute function is on or a JPEG file is playing.

1 Press the home button to switch to the home display.

Using fader/balance adjustment

Fader/Balance displays when Rear Speaker is set to **Full** on the System Menu.

You can change the fader/balance setting to provide an ideal listening environment for all of the occupied seats.

1 Press the home button to switch to the home display.

2 Touch the audio function key to open the audio menu.

3 Touch Fader/Balance on the audio function menu.

4 Touch \wedge or \vee to adjust the front/rear speaker balance.

Range: **Front 15 to Rear 15**

- Select **F/R 0 L/R 0** when only using two speakers.

5 Touch \langle or \rangle to adjust the left/right speaker balance.

Range: **Left 15 to Right 15**

Note

You can also set the fader/balance by dragging the dot on the displayed table. 

Using balance adjustment

Balance displays when Rear Speaker is set to **Subwoofer** on the System Menu. This setting will allow you to adjust the balance between right/left sound output.

1 Press the home button to switch to the home display.

2 Touch the audio function key to open the audio menu.

3 Touch Balance on the audio function menu.

4 Touch \langle or \rangle to adjust the left/right speaker balance.

Range: **Left 15 to Right 15**

Note

You can also set the balance by dragging the dot on the displayed table. 

Using the equalizer

You can adjust the equalization to match the car's interior acoustic characteristics as desired.

Recalling equalizer curves

There are seven stored equalizer curves which you can easily recall at any time. Here is a list of the equalizer curves.

Display	Equalizer curve
S.Bass	Super bass
Powerful	Powerful
Natural	Natural
Vocal	Vocal
Flat	Flat
Custom1	Custom 1
Custom2	Custom 2

- The equalizer curves for **Custom1** and **Custom2** can be adjusted.
- You cannot select **Custom1** and **Custom2** when using the auto-equalizer.
- When **Flat**, no changes are made to the sound. You can check the effects of the equalizer curves by switching alternatively between **Flat** and another equalizer curve.

1 Press the home button to switch to the home display.

2 Touch the audio function key to open the audio menu.

Audio adjustments

3 Touch Graphic EQ on the audio function menu.

▪ You cannot select or adjust the equalizer curves of **Custom1** and **Custom2** when using the auto-equalizer.

4 Touch the desired setting.

S.Bass—Powerful—Natural—Vocal—Flat—Custom1—Custom2

Adjusting the 8-band graphic equalizer

You can adjust the level of each band for the equalizer curves.

- A separate **Custom1** curve can be created for each source. If you make adjustments when a curve other than **Custom2** is selected, the equalizer curve settings will be stored in **Custom1**.
- A **Custom2** curve that is common for all sources can be created. If you make adjustments when the **Custom2** curve is selected, the **Custom2** curve will be updated.

1 Press the home button to switch to the home display.

2 Touch the audio function key to open the audio menu.

3 Touch Graphic EQ on the audio function menu.

4 Touch the desired setting.

S.Bass—Powerful—Natural—Vocal—Flat—Custom1—Custom2

5 Touch the table to adjust the level of the equalizer band.

Range: **+12dB** to **-12dB** 

Using the auto-equalizer

The auto-equalizer is an equalizer curve created by auto EQ (refer to *Auto EQ (auto-equaliz-*

ing) on page 64).

You can turn the auto-equalizer on or off.

If you connect an optional microphone to this unit, you can use this function.

1 Press the home button to switch to the home display.

2 Touch the audio function key to open the audio menu.

3 Touch Auto EQ to turn the auto-equalizer on or off.

▪ You cannot use this function if auto EQ has not been carried out. 

Using sonic center control

Sound that is suited for the listening position can easily be created with this function.

1 Press the home button to switch to the home display.

2 Touch the audio function key to open the audio menu.

3 Touch Sonic Center Control on the audio function menu.

4 Touch < or > to select a listening position.

Range: **Left 7** to **Right 7** 

Adjusting loudness

Loudness compensates for deficiencies in the low-frequency and high-frequency ranges at low volume.

1 Press the home button to switch to the home display.

2 Touch the audio function key to open the audio menu.

Audio adjustments

3 Touch ◀ or ▶ to select a desired level for loudness.

Off (off)—Low (low)—Mid (mid)—High (high) ▣

Using subwoofer output

This unit is equipped with a subwoofer output which can be turned on or off.

- The cut-off frequency and output level can be adjusted when the subwoofer output is on.

1 Press the home button to switch to the home display.

2 Touch the audio function key to open the audio menu.

3 Touch Subwoofer on the audio function menu.

4 Touch On or Off next to Subwoofer to turn the subwoofer output on or off.

5 Touch Normal or Reverse next to Phase to select the phase of subwoofer output.

6 Touch ◀ or ▶ next to Level to adjust the output level of the subwoofer.

Range: **+6 to -24**

7 Touch ◀ or ▶ next to Frequency to select the cut-off frequency.

50Hz—63Hz—80Hz—100Hz—125Hz

Only frequencies lower than those in the selected range are outputted from the subwoofer. ▣

Boosting the bass

You can boost the bass level.

1 Press the home button to switch to the home display.

2 Touch the audio function key to open the audio menu.

3 Touch ◀ or ▶ to select a desired level.

Range: **0 to +6 ▣**

Using the high pass filter

When you do not want low sounds from the subwoofer output frequency range to play from the front or rear speakers, turn on the HPF (high pass filter). Only frequencies higher than those in the selected range are output from the front or rear speakers.

1 Press the home button to switch to the home display.

2 Touch the audio function key to open the audio menu.

3 Touch ◀ or ▶ next to the frequency to select cut-off frequency.

Off (off)—50Hz—63Hz—80Hz—100Hz—125Hz

Only frequencies higher than those in the selected range are output from the front or rear speakers. ▣

Adjusting source levels

With SLA (source level adjustment), the volume levels of each source can be adjusted to prevent significant differences between sources.

- Settings are based on the FM volume level, which remains unchanged.

1 Press the home button to switch to the home display.

2 Touch the audio function key to open the audio menu.

3 Compare the FM volume level with the level of the source you wish to adjust.

4 Touch Source Level Adjuster on the audio function menu.

Audio adjustments

5 Touch \wedge or \vee to adjust the source volume.

Range: +4 to -4

Notes

- **Source Level Adjuster** is not available when FM is selected as the source.
- The MW/LW volume level can also be adjusted with this function.
- Video CD, CD, compressed audio, DivX, MPEG-1, MPEG-2 and MPEG-4 are automatically set to the same source level adjustment volume. 

Setting the subtitle language

You can set a desired subtitle language. When available, the subtitles will be displayed in the selected language.

1 Press the home button to switch to the home display.

2 Touch the video setup key to open the video setup menu.

3 Touch Subtitle Language on the Video Setup menu.

A subtitle language menu is displayed.

4 Touch the desired language.

The subtitle language is set.

- If you have selected **Others**, refer to *When you select Others* on this page.

Notes

- If the selected language is not available, the language specified on the disc is displayed.
- You can also switch the subtitle language by touching the switch subtitle languages key during playback.
- The setting made here will not be affected even if the subtitle language is switched during playback using the switch subtitle languages key.

When you select Others

A language code input display is shown when **Others** is selected. Refer to *Language code chart for DVD* on page 92.

● **Touch 0 to 9 to input the language code.**

- To cancel the entered numbers, touch **C**.
- To register the code, touch the following touch panel key.



Registering the code.



Setting the audio language

You can set the preferred audio language.

1 Press the home button to switch to the home display.

2 Touch the video setup key to open the video setup menu.

3 Touch Audio Language on the Video Setup menu.

An audio language menu is displayed.

4 Touch the desired language.

The audio language is set.

- If you have selected **Others**, refer to *When you select Others* on this page.

Notes

- If the selected language is not available, the language specified on the disc is used.
- You can also switch the audio language by touching the switch audio languages key during playback.
- The setting made here will not be affected even if the audio language is switched during playback using the switch audio languages key. 

Setting the menu language

You can set the preferred language in which the menus recorded on a disc are displayed.

1 Press the home button to switch to the home display.

2 Touch the video setup key to open the video setup menu.

3 Touch Menu Language on the Video Setup menu.

A menu language menu is displayed.

4 Touch the desired language.

The menu language is set.

- If you have selected **Others**, refer to *When you select Others* on this page.

Setting up the video player

Note

If the selected language is not available, the language specified on the disc is displayed. 

Setting the multi-angle DVD display

The angle icon can be set so it appears on scenes where the angle can be switched.

- 1 Press the home button to switch to the home display.
- 2 Touch the video setup key to open the video setup menu.
- 3 Touch Multi Angle on the Video Setup menu to turn angle icon display on or off. 

Setting the aspect ratio

There are two kinds of display: a wide screen display that has a width-to-height ratio (TV aspect ratio) of 16:9, and regular display that has a TV aspect of 4:3. Be sure to select the correct TV aspect for the display connected to **V OUT**.

- When using regular display, select either **Letter Box** or **Pan Scan**. Selecting **16:9** may result in an unnatural picture.
- If you select the TV aspect ratio, the unit's display will change to the same setting.



- 1 Press the home button to switch to the home display.
- 2 Touch the video setup key to open the video setup menu.
- 3 Touch TV Aspect on the Video Setup menu to select the TV aspect ratio.

Touch **TV Aspect** repeatedly until the desired aspect ratio appears.

- **16:9** – Wide screen picture (16:9) is displayed as is (initial setting)

- **Letter Box** – The picture is the shape of a letterbox with black bands on the top and bottom of the screen
- **Pan Scan** – The picture is cut short on the right and left sides of the screen

Notes

- When playing discs that do not specify **Pan Scan**, the disc is played back in **Letter Box** display even if you select the **Pan Scan** setting. Confirm whether the disc package bears the  mark.
- The TV aspect ratio cannot be changed for some discs. For details, refer to the disc's instructions. 

Setting the slideshow interval

JPEG files can be viewed as a slideshow on this unit. In this setting, the interval between each image can be set.

- 1 Press the home button to switch to the home display.
- 2 Touch the video setup key to open the video setup menu.
- 3 Touch Time Per Photo Slide on the Video Setup menu to select the slideshow interval.

Touch **Time Per Photo Slide** repeatedly until the desired setting appears.

- **5sec** – JPEG images switch at intervals of 5 seconds
- **10sec** – JPEG images switch at intervals of 10 seconds
- **15sec** – JPEG images switch at intervals of 15 seconds
- **Manual** – JPEG images can be switched manually 

Setting parental lock

Some DVD video discs let you use parental lock to restrict children from viewing violent and adult-oriented scenes. You can set parental lock to the desired level.

- When you have a parental lock level set and play a disc featuring parental lock, code number input indications may be displayed. In such cases, playback will begin when the correct code number is entered.

Setting the code number and level

A code number must be registered in order to play back discs with parental lock.

1 Press the home button to switch to the home display.

2 Touch the video setup key to open the video setup menu.

3 Touch Parental on the Video Setup menu.

4 Touch 0 to 9 to input a four digit code number.

- To cancel the entered numbers, touch **C**.
- To register the code, touch the following touch panel key.



Registering the code.

The code number is set, and the level can now be set.

5 Touch 1 to 8 to select the desired level.

6 Touch Enter.

The parental lock level is set.

- **8** – Playback of the entire disc is possible (initial setting)
- **7 to 2** – Playback of discs for children and non-adult-oriented discs is possible
- **1** – Playback of discs for children only is possible

Notes

- We recommend to keep a record of your code number in case you forget it.

- The parental lock level is stored on the disc. Look for the level indication written on the disc package, included literature or on the disc itself. Parental lock of this unit is not possible if a parental lock level is not stored on the disc.
- With some discs, the parental lock may be active only for certain levels of scenes. The playback of those scenes will be skipped. For details, refer to the instruction manual that came with the disc.

Changing the level

You can change the set parental lock level.

1 Press the home button to switch to the home display.

2 Touch the video setup key to open the video setup menu.

3 Touch Parental on the Video Setup menu.

4 Touch 0 to 9 to input the registered code number.

5 Registering the code.



Registering the code.

This sets the code number, and the level can now be changed.

- If you enter an incorrect code number, the  icon is displayed. Touch **C** and enter the correct code number.
- If you forget your code number, refer to *If you forget your code number* on this page.

6 Touch 1 to 8 to select the desired level.

7 Touch Enter.

The new parental lock level is set.

If you forget your code number

- Press **RESET**. 

Setting up the video player

Setting the DivX subtitle file

You can select whether or not to display DivX external subtitles.

- The DivX subtitles will be displayed even when **Custom** is selected if no DivX external subtitle files exist.

1 Press the home button to switch to the home display.

2 Touch the video setup key to open the video setup menu.

3 Touch DivX® Subtitle on the Video Setup menu to select the desired subtitle setting.

- **Original** – Display the DivX subtitles
- **Custom** – Display the DivX external subtitles

Notes

- Up to 42 characters can be displayed on one line. If more than 42 characters are set, the line breaks and the characters are displayed on the next line.
- Up to 126 characters can be displayed on one screen. If more than 126 characters are set, the excess characters will not be displayed.

Displaying the DivX® VOD registration code

In order to play DivX VOD (video on demand) contents on this unit, the unit must first be registered with a DivX VOD contents provider. For registration, generate a DivX VOD registration code and submit it to your provider.

- Keep a record of the code as you will need it when you register your unit to the DivX VOD provider.

1 Press the home button to switch to the home display.

2 Touch the video setup key to open the video setup menu.

3 Touch DivX® VOD on the Video Setup menu.

Registration Code and **Deregistration Code** appear.

4 Touch Registration Code.

Your registration code is displayed.

Displaying the deregistration code

If your device is already registered, deregister it by entering the deregistration code.

1 Press the home button to switch to the home display.

2 Touch the video setup key to open the video setup menu.

3 Touch DivX® VOD on the Video Setup menu.

4 Touch Deregistration Code.

- To cancel deregistration, touch **Cancel**.

5 Touch OK.

The deregistration is complete.

Automatic playback of DVDs

When a DVD disc with a DVD menu is inserted, this unit will cancel the menu automatically and start playback from the first chapter of the first title.

- Some DVDs may not operate properly. If this function is not fully operable, turn this function off and start playback.

1 Press the home button to switch to the home display.

2 Touch the video setup key to open the video setup menu.

3 Touch DVD Auto Play to turn automatic playback on.

- To turn automatic playback off, touch **DVD Auto Play** again.

Switching the auxiliary setting

Activate this setting when using an auxiliary device connected to this unit.

- 1 Press the home button to switch to the home display.
- 2 Touch the system key to open the system menu.
- 3 Touch AUX Input on the system menu to turn AUX Input on or off.

Setting AV input

Activate this setting when using an external video component connected to this unit.

- 1 Press the home button to switch to the home display.
- 2 Touch the system key to open the system menu.
- 3 Touch AV Input on the system menu to turn AV Input on or off.

Setting the RGB Input

Settings are required according to the connected device.

RGB Input can be set when all of the following conditions are met.

- The iPhone is not connected to RGB input.
- No Bluetooth connection.
- The source is turned off.

- 1 Turn the source off.

Refer to **Source off key** on page 10.

- 2 Press the home button to switch to the home display.
- 3 Touch the system key to open the system menu.
- 4 Touch RGB Input on the system menu to select the RGB input.

- 5 Touch the desired setting.

- **iPhone (CD-IU201S)** – iPod with 30-pin connector
- **iPhone (VGA adapter)** – iPod with lighting connector (AVH-X5500BT/AVH-X3500DAB/AVH-X2500BT)
- **NAVI** – Navigation system

Setting the App sound mixing

Refer to *Setting the App sound mixing* on page 36.

Setting MIXTRAX mode

Refer to *Setting MIXTRAX mode* on page 44.

Changing the picture adjustment

You can adjust the **Brightness** (brightness), **Contrast** (contrast), **Color** (color), **Hue** (hue), **Dimmer** (dimmer), and **Temperature** (temperature) for each source and rear view camera.

- You cannot adjust **Color**, **Hue** and **Contrast** for the audio source.

- 1 Press the home button to switch to the home display.
- 2 Touch the system key to open the system menu.

System settings

3 If you are adjusting the Picture Adjustment, select the unit.

NAVI	Completing Picture Adjustment for the Navigation system when the RGB input setting is set to NAVI .
Apps	Completing Picture Adjustment for the AppRadio Mode when the RGB input setting is set to iPhone (CD-IU2015) or iPhone (VGA adapter) .
Rear View	Adjusting the Picture Adjustment for the rear view camera.
Source	Adjusting the Picture Adjustment for the source.

4 Touch any of the following touch panel keys to select the function to be adjusted.

Picture Adjustment items are displayed.

- **Brightness** – Adjusts the black intensity
- **Contrast** – Adjusts the contrast
- **Color** – Adjusts the color saturation
- **Hue** – Adjusts the tone of color (red or green is emphasized)
- **Dimmer** – Adjusts the brightness of the display
- **Temperature** – Adjusts the color temperature, resulting in a better white balance
- **RGB Dot Adjustment** – Adjusts phase shifting by dot clock when a Navigation system is connected
 - You can adjust **Hue** only when the color system is set to NTSC.
 - With some rear view cameras, picture adjustment may not be possible.

5 Touch ◀ or ▶ to adjust the selected item.

Each time you touch ◀ or ▶, the level of the selected item increases or decreases.

- **Dimmer** can be adjusted from **+1** to **+48**.
- **Temperature** can be adjusted from **+3** to **-3**.

6 Touch RGB Dot Adjustment to adjust.

- **RGB Dot Adjustment** can be set to **1** or **2**.

Notes

- You cannot operate this function while driving.
- Different **Brightness/Contrast/Dimmer** settings can be set for when the illumination switch is on and when it is off. 

Selecting the system language

The system language can be selected.

If text information such as the title name, artist name or a comment is embedded in a European language, they can also be displayed on this unit.

- The language can be changed for the following:
 - Audio menu
 - System menu
 - Video Setup menu
 - Bluetooth menu
 - On-screen display (English and Russian only)
 - Multi language setting for DivX (English and Russian only)
 - Language for cautions
- Some operations on this unit are prohibited from use while driving or require careful attention when operated. In such cases, a caution will appear on the display. You can change the language for caution messages with this setting.
- If the embedded language and the selected language setting are not the same, text information may not display properly.
 - Some characters may not be displayed properly.

1 Press the home button to switch to the home display.

2 Touch the system key to open the system menu.

3 Touch System Language on the system menu to select the desired language.

4 Touch the desired language.

English (English)—**Português** (Portuguese)—**Español** (Spanish)—**Français** (French)—**Deutsch** (German)—**Русский** (Russian)—**Italiano** (Italian)—**Nederlands** (Netherlands)—**Türkçe** (Turkish)

Setting Demo Mode

Once Demo Mode is turned on, the Demo screen appears.

Refer to *Demo mode* on page 8.

1 Press the home button to switch to the home display.

2 Touch the system key to open the system menu.

3 Touch Demo mode on the system menu to turn Demo mode on or off.

- **On** – The Demo screen appears.
- **Off** – The Demo screen does not appear.

Switching sound muting/attenuation

Sound from this system is automatically muted or attenuated when a signal from equipment with a mute function is received.

- Sound from this system returns to normal when the muting or attenuation is canceled.

1 Press the home button to switch to the home display.

2 Touch the system key to open the system menu.

3 Touch Mute/ATT until the desired setting appears.

Touch **Mute/ATT** until the desired setting appears in the display.

- **Mute** – Muting
- **ATT –20dB** – Attenuation (**ATT –20dB** has a stronger effect than **ATT –10dB**)
- **ATT –10dB** – Attenuation

- **Off** – Turns the sound muting/attenuation off

Notes

- When **Mute** is displayed, the sound is turned off and no audio adjustments can be made.
- When **ATT** is displayed, the sound is attenuated and only the volume can be adjusted. (No other audio adjustments can be made.)
- Operation returns to normal when the phone connection is ended.

Setting the rear output and subwoofer controller

This unit's rear output (rear speaker leads output and RCA rear output) can be used for full-range speaker (**Full**) or subwoofer (**Subwoofer**) connection. If you switch the rear output setting to **Subwoofer**, you can connect a rear speaker lead directly to a subwoofer without using an auxiliary amp. Initially, the unit is set for a rear full-range speaker connection (**Full**).

1 Turn the source off.

Refer to *Turning the source ON/OFF* on page 10.

2 Press the home button to switch to the home display.

3 Touch the system key to open the system menu.

4 Touch Rear Speaker on the system menu to switch the subwoofer output or full-range speaker.

- When no subwoofer is connected to the rear output, select **Full** (full-range speaker).
- When a subwoofer is connected to the rear output, select **Subwoofer** (subwoofer).

Notes

- Even if you change this setting, there will be no output unless you turn the subwoofer output on (refer to *Using subwoofer output* on page 54).

System settings

- Both rear speaker lead outputs and RCA rear output are switched simultaneously in this setting. 

Using the keyboard

Keyboard is available only in **AppRadio Mode**.

Refer to *Setting the Keyboard* on page 36. 

Setting the ever scroll

When ever scroll is set to **On**, recorded text information scrolls continuously in the display. Set to **Off** if you prefer the information to scroll just once.

- Press the home button to switch to the home display.
- Touch the system key to open the system menu.
- Touch **Ever Scroll** on the system menu to turn ever scroll on or off. 

Setting the Bluetooth audio

(Function of AVH-X5500BT/AVH-X3500DAB/AVH-X2500BT)

You need to activate the **Bluetooth Audio** source in order to use a Bluetooth audio player.

- Press the home button to switch to the home display.
- Touch the system key to open the system menu.
- Touch **Bluetooth Audio** on the system menu to turn Bluetooth audio on or off. 

Clearing Bluetooth memory

Important

Never turn the unit off while the Bluetooth memory is being cleared.

- Turn the source off.**
Refer to *Turning the source ON/OFF* on page 10.
- Press the home button to switch to the home display.**
- Touch the system key to open the system menu.**
- Touch Bluetooth Memory Clear on the system menu.**
- Touch Clear.**
After selecting a desired item, a confirmation display appears. Touch **OK** to delete the memory.
 - If you do not want to clear the memory, touch **Cancel**. 

Updating Bluetooth connection software

This function is used to update this unit with the latest Bluetooth software. For about Bluetooth software and updating, refer to our website.

Important

Never turn the unit off and never disconnect the phone while the software is being updated.

- Turn the source off.**
Refer to *Turning the source ON/OFF* on page 10.
- Press the home button to switch to the home display.**
- Touch the system key to open the system menu.**
- Touch BT Software Update.**

5 Touch Start to display the data transfer mode.

- Follow the on-screen instructions to finish updating the Bluetooth software. 

Displaying the Bluetooth system version

If this unit fails to operate properly, you may need to consult your dealer for repair. In such cases, you may be asked to specify the system version. Perform the following procedure to check the version on this unit.

1 Turn the source off.

Refer to *Turning the source ON/OFF* on page 10.

2 Press the home button to switch to the home display.

3 Touch the system key to open the system menu.

4 Touch Bluetooth Version Information to display to the version of the Bluetooth module of this unit.

Setting the Bluetooth safe mode

Refer to *Setting the Bluetooth safe mode* on page 70. 

Setting the rear view camera (back up camera)

CAUTION

Pioneer recommends the use of a camera which outputs mirror-reversed images. Otherwise, the screen image will appear reversed.

This unit features a function that automatically switches to the rear view camera video (**R.C IN**) when a rear view camera is installed on

your car and the shift lever is moved to the **REVERSE (R)** position. (For more details, consult your dealer.)

You can also switch the rear view image by pressing the touch key.

For details refer to *Using the rear view* on page 13.

- After you set up the rear view camera setting, move the shift lever to **REVERSE (R)** and confirm that the rear view camera video is shown on the display.
- Change this setting if the display switches to the rear view camera video by error while you are driving forward.
- To stop watching the rear view camera video and return to the source display, press and hold **MUTE**.
- Touch the **RearView** source icon to display the rear view camera image while driving. Touch the source icon again to turn the rear view camera off. For details, refer to *Selecting a source* on page 11.

1 Press the home button to switch to the home display.

2 Touch the system key to open the system menu.

3 Touch Camera Polarity on the system menu to select the appropriate setting.

- Battery** – When the polarity of the connected lead is positive while the shift lever is in **REVERSE (R)** position
- Ground** – When the polarity of the connected lead is negative while the shift lever is in **REVERSE (R)** position
- Off** – When a rear view camera is not connected to this unit
- The rear view key setting also turns off on the home display screen. 

Auto EQ (auto-equalizing)

The auto-equalizer automatically measures the car's interior acoustic characteristics, and then creates an auto-equalizer curve based on that information.

System settings

- To perform this function, dedicated microphone (e.g. CD-MC20) is required.

WARNING

As a loud tone (noise) may be emitted from the speakers when measuring the car's interior acoustic characteristics, never perform auto TA or auto EQ while driving.

CAUTION

- Thoroughly check the conditions before performing auto EQ as the speakers may be damaged if these functions are performed when:
 - The speakers are incorrectly connected. (For example, when a rear speaker is connected as a subwoofer output.)
 - A speaker is connected to a power amp delivering output higher than the speaker's maximum input power capability.
- If the microphone is placed in an unsuitable position the measurement tone may become loud and measurement may take a long time, resulting in battery drainage. Be sure to place the microphone in the specified location.

Before operating the auto EQ function

- Carry out auto EQ in as quiet a place as possible, with the car engine and air conditioning switched off. Also cut power to car phones or portable telephones in the car, or remove them from the car before carrying out auto EQ. Sounds other than the measurement tone (surrounding sounds, engine sound, telephones ringing etc.) may prevent correct measurement of the car interior acoustic characteristics.
- Be sure to carry out auto EQ using the optional microphone. Using another microphone may prevent measurement, or result in incorrect measurement of the car interior acoustic characteristics.
- In order to perform auto EQ, the front speaker must be connected.
- When this unit is connected to a power amp with input level control, auto EQ may

not be possible if the power amp's input level is set below the standard level.

- When this unit is connected to a power amp with an LPF, turn this LPF off before performing auto EQ. Also set the cut-off frequency for the built-in LPF of an active subwoofer to the highest frequency.
- The distance has been calculated by computer to be the optimum delay to give accurate results for the circumstances, so please continue to use this value.
 - The reflected sound within the car is strong and delays occur.
 - The LPF on active subwoofers or external amps delay the lower sounds.
- Auto EQ changes the audio settings as follows:
 - The fader/balance settings return to the center position. (Refer to *Using fader/balance adjustment* on page 52.)
 - The equalizer curve switches to **Flat**. (Refer to *Recalling equalizer curves* on page 52.)
 - The front, center and rear speakers will automatically be adjusted to a high pass filter setting.
- Previous settings for auto EQ will be overwritten.
- If using an AVH-X3500DAB, AVH-X2500BT, or AVH-X1500DVD, connect a microphone extension cable (sold separately) to the AUX input in advance.

Performing auto EQ

1 Stop the car in a place that is quiet, close all the doors, windows and sun roof, and then turn the engine off.

If the engine is left running, engine noise may prevent correct auto EQ.

2 Fix the optional microphone in the center of the headrest of the driver's seat, facing forward.

The auto EQ may differ depending on where you place the microphone. If desired, place the microphone on the front passenger seat to carry out auto EQ.

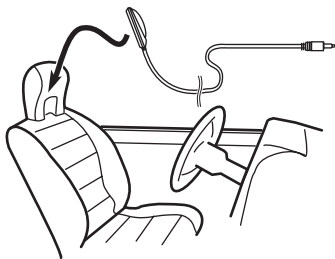

3 Turn the ignition switch to ON or ACC.

If the car's air conditioner or heater is turned on, turn it off. Noise from the fan in the air conditioner or heater may prevent correct auto EQ.

4 Press the home button to switch to the home display.

5 Touch the system key to open the system menu.

6 Touch Auto EQ Measurement to enter auto EQ measurement mode.

7 Plug the microphone into the microphone input jack on this unit.

AVH-X5500BT

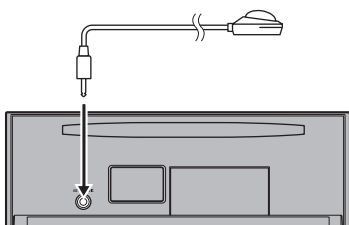

AVH-X3500DAB, AVH-X2500BT and AVH-X1500DVD

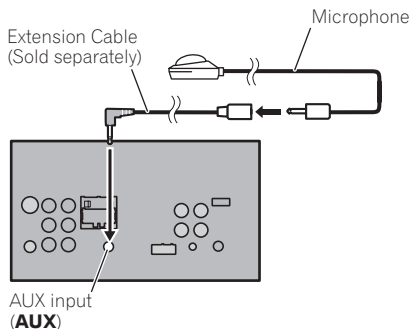

8 Touch Start to start auto EQ.

9 When the 10-second countdown starts, get out of the car and close the door within 10 seconds.

A measurement tone (noise) is emitted from the speakers, and auto EQ measurement begins.

When auto EQ is completed, **The measurement has finished. Please disconnect the microphone and then push HOME key.** is displayed.

When the car's interior acoustic characteristics cannot be measured correctly, an error message will be displayed. (Refer to *Understanding auto EQ error messages* on page 80.)

- It takes about nine minutes for auto EQ measurement to be completed when all the speakers are connected.
- To stop auto EQ, touch **Stop**.

10 Store the microphone carefully in the glove compartment or another safe place.

If the microphone is subjected to direct sunlight for an extended period, high temperatures may cause distortion, color change or malfunction. ▣

Selecting the video format

You can switch the video output format of **V OUT** between NTSC and PAL.

System settings

1 Press the home button to switch to the home display.

2 Touch the system key to open the system menu.

3 Touch Video Output Format on the system menu to select the video output format.

NTSC—PAL

Note

You can switch the video output format only for the source from this unit. 

Setting the video signal

When you connect this unit to an AV equipment to this unit, select the suitable video signal setting.

- As this function is initially set to **Auto**, the unit will automatically adjust the video signal setting.
- You can operate this function only for the video signal input into the AV input.

1 Press the home button to switch to the home display.

2 Touch the system key to open the system menu.

3 Touch Video Signal Setting on the function menu.

Video Signal Setting items are displayed.

- **AV** – Adjusts the AV video signal
- **AUX** – Adjusts the AUX video signal
- **Camera** – Adjusts the rear view camera video signal

4 Touch ◀ or ▶ to select the desired video signal appears.

Auto—PAL—NTSC—PAL-M—PAL-N—SECAM 

Using the Favorite menu

1 Display menu columns to register.

Refer to *Menu operations* on page 51.

- You can customize menus except

Video Setup menu.

2 Touch the star icon in the menu column for the desired menu to register the menu.

The star icon for the selected menu is filled in.

- To cancel the registration, touch the star icon in the menu column again.

3 Display the favorite menu and choose a registered menu.

Refer to *Menu operations* on page 51.

Note

You can register up to 12 columns. 

Bluetooth connection menu

Bluetooth connection menu operations

(Function of AVH-X5500BT/AVH-X3500DAB/AVH-X2500BT)

Note

If you are using a cellular phone that can be connected via Bluetooth wireless technology, we recommend that you use your phone to search for this unit and establish a connection between it and your phone. The PIN code is set to **0000** as default. The product name for this unit will display on your phone as the device name. For details, refer to *Entering PIN code for Bluetooth wireless connection* on the next page. For further details concerning the procedures for establishing Bluetooth wireless connections, refer to the instruction manual for the phone.

Pairing from this unit

- 1 Press the home button to switch to the home display.
- 2 Touch the Bluetooth key to open the Bluetooth connection menu.
- 3 Touch Connection to select a device.
- 4 Start to search.



Starting to search.

While searching,  is displayed and when available devices are found, the device names or Bluetooth device addresses (if names cannot be obtained) are displayed.

- If you want to switch between the device names and Bluetooth device addresses, touch the icon.



Switching between the device names and Bluetooth device addresses.

- To cancel searching, touch **Stop**.

- If three devices are already paired, **Memory Full** is displayed and pairing cannot be performed. In such cases, delete a paired device first. Refer to this page.
- If no device can be found, **Not Found** is displayed. In such cases, check the status of the Bluetooth device and search again.

5 Touch a device name to select the device you want to connect to.

While connecting, **Pairing** is displayed. If the connection is established, **Paired** is displayed.

- If your device support SSP (Secure Simple Pairing), 6-digit number appears on the display of this unit. Once the connection is established, this number disappears.
- If the connection fails, **Error** is displayed. In such cases, try again from the beginning.
- The PIN code is set to **0000** as the default, but can be changed. Refer to *Entering PIN code for Bluetooth wireless connection* on the next page.
- Once the connection is established, the device name is displayed. Touch the device name to disconnect.
- If you want to delete a paired Bluetooth telephone, display **Delete OK?**. Touch **Yes** to delete the device.



Deleting a paired device.

- Never turn the unit off while the paired Bluetooth telephone is being deleted.

Connecting to a Bluetooth device automatically

If this function is set to on, a connection between your Bluetooth device and this unit will take place automatically as soon as the two devices are less than a few meters apart. Initially, this function is set to on.

- 1 Press the home button to switch to the home display.

Bluetooth connection menu

2 Touch the Bluetooth key to open the Bluetooth connection menu.

3 Touch Auto Connect to turn automatic connection on.

If your Bluetooth device is ready for a Bluetooth wireless connection, a connection to this unit will automatically be established.

- To turn automatic connection off, touch **Auto Connect** again.

If connection fails, "**Auto connection failed. Retry?**" appears. Touch **Yes** to reconnect.

4 Once you turn your vehicle's ACC switch on again, a connection is established automatically.

Switching visible unit

This function sets whether or not to make this unit visible to the other device. Initially, this function is set to on.

1 Press the home button to switch to the home display.

2 Touch the Bluetooth key to open the Bluetooth connection menu.

3 Touch Visibility to select visibility off.

- To turn visibility on, touch **Visibility** again.

Entering PIN code for Bluetooth wireless connection

To connect your Bluetooth device to this unit via Bluetooth wireless technology, you need to enter a PIN code on your Bluetooth device to verify the connection. The default code is **0000**, but you can change it with this function.

1 Press the home button to switch to the home display.

2 Touch the Bluetooth key to open the Bluetooth connection menu.

3 Touch PIN Code Input to select PIN Code Input.

4 Touch 0 to 9 to input pin code.

5 After inputting PIN code (up to 8 digits), store in this unit.



Storing the PIN code in this unit.

Displaying Bluetooth Device address

This unit displays its Bluetooth device address.

1 Press the home button to switch to the home display.

2 Touch the Bluetooth key to open the Bluetooth connection menu.

3 Touch Device Information to display device information.

The Bluetooth device address is displayed.

Setting the Bluetooth safe mode

This setting restricts your operation for Bluetooth device while driving.

If this mode is set to on, the following operations are not possible.

- Use of the keyboard function in **AppRadio Mode**
- Calling using entering phone number mode
- All operations in the Bluetooth connection menu



CAUTION

For your safety, safe mode must always be set "**On**" while driving.

1 Press the home button to switch to the home display.

2 Touch the system key to open the system menu.

3 Touch Safe Mode on the system menu to turn Bluetooth safe mode on or off.

Theme menu

Selecting the illumination color

This unit is equipped with multiple-color illumination.

Direct selection from preset illumination colors

You can select an illumination color from the color list.

- 1 Press the home button to switch to the home display.
- 2 Touch the theme key to open the theme settings.
- 3 Touch Illumination and then touch a color on the list.

Customizing the illumination color

- 1 Press the home button to switch to the home display.
- 2 Touch the theme key to open the theme settings.
- 3 Touch Illumination and then touch Custom.
- 4 Display the customizing menu.



Displaying the customizing menu.

- 5 Touch the color bar to customize the color.
- 6 Touch ◀ or ▶ to fine-tune the color.
- 7 Touch the icon and hold to store the customized color in the memory.

Memo

Storing the customized color in the memory.

The customized color has been stored in the memory.

The set color will be recalled from the memory the next time you touch the same icon. □

Selecting the OSD (on-screen display) color

The OSD color can be changed.

- 1 Press the home button to switch to the home display.
- 2 Touch the theme key to open the theme settings.
- 3 Touch Screen.
- 4 Touch one of the colors on the list. □

Selecting the background display

You can switch the background that is displayed when listening to a source.

- 1 Press the home button to switch to the home display.
- 2 Touch the theme key to open the theme settings.
- 3 Touch Background.
- 4 Touch the desired setting.
 - If no JPEG images are stored in this unit, you cannot select photo. To store a JPEG image to this unit, refer to *Capture an image in JPEG files* on page 40.
 - If you want to delete the captured JPEG image, touch and hold the key of the JPEG image.
 - You can view the hidden settings by flicking the display. □

Adjusting the response positions of the touch panels (Touch Panel Calibration)

If you feel that the touch panel keys on the screen deviate from the actual positions that respond to your touch, adjust the response positions of the touch panel. There are two adjustment methods: 4-point adjustment, in which you touch four corners of the screen; and 16-point adjustment, in which you make fine-adjustments on the entire screen.

- Park your car in a safe place and use this function. Do not operate it while driving.
- Touch the screen gently for adjustment. Forcefully pressing the touch panel may damage the touch panel. Do not use a sharp pointed tool such as a ballpoint pen or mechanical pen. Doing so may damage the screen.
- If the touch panel cannot be adjusted properly, consult your local Pioneer dealer.

1 Turn the source off.

Refer to *Turning the source ON/OFF* on page 10.

2 Press and hold the home button to start Touch Panel Calibration.

The 4-point touch panel adjustment screen appears. When 2-point appears at once, touch both.

3 Touch each of the arrows on the four corners of the screen.

- To cancel the adjustment, press and hold the home button.

4 Press the home button to complete 4-point adjustment.

Data for the adjusted position is saved.

- Do not turn off the engine while the data is being saved.

5 Press the home button to proceed to 16-point adjustment.

The 16-point touch panel adjustment screen appears.

- To cancel the adjustment, press and hold the home button.

6 Gently touch the center of the + mark displayed on the screen.

After you touch all the marks, the data for the adjusted position is saved.

- Do not turn off the engine while the data is being saved.

7 Press and hold the home button to complete the adjustment.

Using an AUX source

An auxiliary device or portable device sold separately can be connected to this unit.

About AUX connection methods

You can connect auxiliary devices to this unit.

Mini pin plug cable (AUX)

When connecting an auxiliary device using a mini plug cable

iPods and portable audio/video players can be connected to this unit via mini plug cable.

- If an iPod with video capabilities is connected to this unit via 3.5 mm plug (4 pole) cable (such as the CD-V150M), you can enjoy the video contents of the connected iPod.
- A portable audio/video player can be connected by using a 3.5 mm plug (4 pole) with an RCA cable (sold separately). However, depending on the cable, a reverse connection between the red (right side audio) cable and yellow (video) cable may be required in order for the sound and video image to be reproduced correctly.

● Insert the stereo mini plug into the AUX input jack on this unit.

For more details, refer to the installation manual. 

Resetting the microprocessor

By pressing **RESET**, you can reset the microprocessor to its initial settings without changing the bookmark information.

The microprocessor must be reset in the following situations:

- Before using this unit for the first time after installation
- If the unit fails to operate properly
- When strange or incorrect messages appear on the display

1 Turn the ignition switch OFF.

2 Press **RESET** with a pen tip or other pointed instrument.

Refer to *What's what* on page 9.

Note

Switch your engine ON or set the ignition switch to ACC ON before pressing **RESET** in the following situations:

- After completing connections
- When erasing all stored settings
- When resetting the unit to its initial (factory) settings. 

Additional information

Troubleshooting

Common

Symptom	Cause	Action (Reference page)
The power will not turn on. The unit will not operate.	Leads and connectors are incorrectly connected.	Confirm once more that all connections are correct.
	The fuse is blown.	Rectify the cause and then replace the fuse. Be sure to install a fuse with the same rating.
	Noise and/or other factors are causing the built-in microprocessor to operate incorrectly.	Press RESET . (Page 73)
Operation with the remote control is not possible. The unit does not operate correctly even when the appropriate remote control buttons are pressed.	Battery power is low.	Load a new battery.
	Some operations are prohibited with certain discs.	Try operating with another disc.
Playback is not possible.	The disc is dirty.	Clean the disc.
	The type of disc loaded cannot be played on this unit.	Check the disc type.
	The disc loaded is not compatible with this video system.	Change the disc to one that is compatible with your video system.
There is no sound. The volume level will not rise.	Cables are not connected correctly.	Connect the cables correctly.
	The unit is performing still, slow motion or frame-by-frame playback.	There is no sound during still, slow motion or frame-by-frame playback.

Symptom	Cause	Action (Reference page)
There is no image displayed.	The parking brake cable is not connected.	Connect the parking brake cable, and apply the parking brake.
	The parking brake is not applied.	Connect the parking brake cable, and apply the parking brake.
The  icon is displayed, and operation is not possible.	The operation is prohibited for the disc.	This operation is not possible.
	The operation is not compatible with the configuration of the disc.	This operation is not possible.
The image displayed stops (pauses) and the unit cannot be operated.	The data could no longer be read during playback.	Stop playback once, and start playback again.
There is no sound. The volume level is low.	The volume level is low.	Adjust the volume level.
	The attenuator is on.	Turn the attenuator off.
The sound and video skip.	The unit is not firmly secured.	Firmly secure the unit.
	File size and transmission rate are above recommended rates.	Create a DivX file that is within the recommended size and transmission rate.
The aspect ratio is incorrect and the image is stretched.	The aspect ratio setting is incorrect for the display.	Select the appropriate setting for your display. (Page 57)
The motor sounds when the ignition switch is turned ON (or is turned to ACC).	The unit is confirming whether or not a disc is loaded.	This is a normal operation.

Additional information

Symptom	Cause	Action (Reference page)
Nothing is displayed. The touch panel keys cannot be used.	The rear view camera is not connected. Camera Polarity is at incorrect setting.	Connect a rear view camera. Press the home button to return to the source display and then select the correct setting for Camera Polarity . (Page 64)
No xxxx appears when a display is changed (No Title , for example).	There is no embedded text information.	Switch the display or play another track/file.
Subfolders cannot be played back.	Folder repeat play has been selected.	Select the repeat range again.
The repeat range changes automatically.	Another folder was selected during repeat play. Track search or fast forward/reverse was performed during file repeat play.	Select the repeat range again. Select the repeat range again.

DVD

Symptom	Cause	Action (Reference page)
Playback is not possible.	The loaded disc has a different region number from this unit.	Replace the disc with one featuring the same region number as this unit.
A parental lock message is displayed and playback is not possible.	Parental lock is activated.	Turn parental lock off or change the level. (Page 58)
Parental lock cannot be canceled.	The code number is incorrect. You have forgotten your code number.	Enter the correct code number. (Page 58) Press RESET . (Page 73)

Symptom	Cause	Action (Reference page)
Dialog language (and subtitle language) cannot be switched.	The DVD being played does not feature multiple language recordings. You can only switch between items indicated in the disc menu.	The language cannot be switched if they are not recorded on the disc. Switch the language using the disc menu.
No subtitles are displayed.	The DVD being played does not feature subtitles. You can only switch between items indicated in the disc menu.	Subtitles are not displayed if they are not recorded on the disc. Switch the language using the disc menu.
Playback is not performed with the audio language and subtitle language settings selected in Video Setup menu.	The DVD being played does not feature dialog or subtitles in the selected language.	The language cannot be switched if the selected language is not recorded on the disc.
The viewing angle cannot be switched.	The DVD being played does not feature scenes shot from multiple angles. You are trying to switch to multi-angle viewing for a scene that was not recorded from multiple angles.	The viewing angle cannot be switched if the DVD does not feature scenes recorded from multiple angles. Switch between multiple angles when watching scenes recorded from multiple angles.

Additional information

Symptom	Cause	Action (Reference page)
The image is extremely unclear/distorted and dark during playback.	Some discs feature a signal to prohibit copying.	Since this unit is compatible with the analog copy generation management system, when playing a disc that has a signal prohibiting copying, horizontal stripes or other imperfections may appear when viewed on some displays. This is not a malfunction.

Video CD

Symptom	Cause	Action
The PBC (playback control) menu cannot be called up.	The Video CD being played does not feature PBC.	This operation is not available for Video CDs that do not feature PBC.
Repeat play and track/time search are not possible.	The Video CD being played features PBC.	This operation is not available for Video CDs that feature PBC.

iPod

Symptom	Cause	Action
The iPod does not operate correctly.	The cables are incorrectly connected.	Disconnect the cable from the iPod. Once the iPod's main menu is displayed, reconnect the iPod and reset it.
	The iPod version is old.	Update the iPod version.
Sound from the iPod cannot be heard.	The audio output direction may switch automatically when the Bluetooth and USB connections are used at the same time.	Use the iPod to change the audio output direction.

Bluetooth audio/telephone

Symptom	Cause	Action
The sound from the Bluetooth audio source is not played back.	There is a call in progress on a Bluetooth connected cellular phone.	The sound will be played back when the call is terminated.
	A Bluetooth connected cellular phone is currently being operated.	Do not use the cellular phone at this time.
	A call was made with a Bluetooth connected cellular phone and then immediately terminated. As a result, communication between this unit and the cellular phone was not terminated properly.	Reconnect the Bluetooth connection between this unit and the cellular phone.



Error messages

When you contact your dealer or your nearest Pioneer Service Center, be sure to note the error message.

Common

Message	Cause	Action
AMP Error	This unit fails to operate or the speaker connection is incorrect; the protective circuit is activated.	Check the speaker connection. If the message fails to disappear even after the engine is switched off/on, contact your dealer or an authorized Pioneer Service Station for assistance.

Additional information

DAB tuner

Message	Cause	Action
Antenna Error	The antenna connection is incorrect.	Check the antenna connection. If the message fails to disappear even after the engine is switched off/on, contact your dealer or an authorized Pioneer Service Station for assistance.

Tuner

Message	Cause	Action
No Data Provided	This unit cannot receive artist name/song title information.	Move to the desirable location with good reception.
No Data	This unit cannot receive program service name information.	Move to the desirable location with good reception.

DVD

Message	Cause	Action (Reference page)
Different Region Disc	The disc does not have the same region number as this unit.	Replace the DVD with one bearing the correct region number.
Error-02-XX/FF-FF	The disc is dirty.	Clean the disc.
	The disc is scratched.	Replace the disc.
	The disc is loaded upside down.	Check that the disc is loaded correctly.
	There is an electrical or mechanical error.	Press RESET . (Page 73)
Unplayable Disc	This type of disc cannot be played on this unit.	Replace the disc with one that can be played on this unit.
	The inserted disc does not contain any playable files.	Replace the disc.

Message	Cause	Action (Reference page)
Protect	All the files on the inserted disc are embedded with DRM.	Replace the disc.
Skipped	The inserted disc contains DRM protected files.	Play an audio file not embedded with Windows Media™ DRM 9/10.
TEMP	The temperature of the unit is outside the normal operating range.	Wait until the unit returns to a temperature within the normal operating limits.
This DivX rental has expired.	The inserted disc contains expired DivX VOD content.	Select a file that can be played.
Video resolution not supported	The inserted disc contains a high definition DivX/MPEG-1/MPEG-2/MPEG-4 file.	Select a file that can be played.
It is not possible to write it in the flash.	This unit's flash memory used as the temporary storage area is full.	Select a file that can be played.
Your device is not authorized to play this DivX protected video.	This unit's DivX registration code has not been authorized by the DivX VOD contents provider.	Register this unit to the DivX VOD contents provider.
Unplayable File	This type of file cannot be played on this unit.	Select a file that can be played.
Format Read	Sometimes there is a delay between the start of playback and when you start to hear any sound.	Wait until the message disappears and you hear sound.
Video frame rate not supported	DivX file's frame rate is more than 30 fps.	Select a file that can be played.
Audio Format not supported	This type of file is not supported on this unit.	Select a file that can be played.

Additional information

External storage device (USB)

Message	Cause	Action (Reference page)
Unplayable File	This type of file cannot be played on this unit.	Select a file that can be played.
	There are no songs.	Transfer the audio files to the USB portable audio player/USB memory and connect.
	Security for the connected USB memory is enabled.	Follow the USB memory instructions to disable security.
Format Read	Sometimes there is a delay between the start of playback and when you start to hear any sound.	Wait until the message disappears and you hear sound.
Skipped	The connected USB portable audio player/USB memory contains WMA files that are protected by Windows Media™ DRM 9/10.	Play an audio file not embedded with Windows Media™ DRM 9/10.
Protect	All the files on the connected USB portable audio player/USB memory are protected by Windows Media DRM 9/10.	Transfer audio files not protected by Windows Media DRM 9/10 to the USB portable audio player/USB memory and connect.
Incompatible USB	The USB device connected to is not supported by this unit.	Connect a USB portable audio player or USB memory that is USB Mass Storage Class compliant.
	The USB device is not formatted with FAT12, FAT16 or FAT32.	The connected USB device should be formatted with FAT12, FAT16 or FAT32.

Message	Cause	Action (Reference page)
Check USB	The USB connector or USB cable has short-circuited.	Check that the USB connector or USB cable is not caught in something or damaged.
	The connected USB storage device consumes more than maximum allowable current.	Disconnect the USB portable audio player/USB memory and do not use it. Turn the ignition switch to OFF, then to ACC or ON and then connect a compliant USB portable audio player/USB memory.
Error-02-9X/-DX	Communication failed.	Perform one of the following operations. –Turn the ignition switch OFF and back ON. –Disconnect the USB portable audio player/USB memory. –Change to a different source. Then, return to the USB portable audio player/USB memory.
This DivX rental has expired.	The inserted external storage device contains expired DivX VOD content.	Select a file that can be played.
Video resolution not supported	The inserted external storage device contains a high definition DivX/MPEG-1/MPEG-2/MPEG-4 file.	Select a file that can be played.
It is not possible to write it in the flash.	This unit's flash memory used as the temporary storage area is full.	Select a file that can be played.

Additional information

Message	Cause	Action (Reference page)
Your device is not authorized to play this DivX protected video.	This unit's DivX registration code has not been authorized by the DivX VOD contents provider.	Register this unit to the DivX VOD contents provider.
Format Read	Sometimes there is a delay between the start of playback and when you start to hear any sound.	Wait until the message disappears and you hear sound.
Video frame rate not supported	DivX file's frame rate is more than 30 fps.	Select a file that can be played.
Audio Format not supported	This type of file is not supported on this unit.	Select a file that can be played.
Creating the Database has failed.	The mode was switched to video or JPEG image display while the database was being created.	Create the database again. (Page 39)
iPod		
Message	Cause	Action
Format Read	Sometimes there is a delay between the start of playback and when you start to hear any sound.	Wait until the message disappears and you hear sound.
Error-02-6X/-9X/-DX	Communication failed.	Disconnect the cable from the iPod. Once the iPod's main menu is displayed, reconnect the iPod and reset it.
	iPod failure.	Disconnect the cable from the iPod. Once the iPod's main menu is displayed, reconnect the iPod and reset it.
Error-02-67	The iPod firmware version is old.	Update the iPod version.

Message	Cause	Action
Stop	There are no songs.	Transfer songs to the iPod.
	There are no songs in the current list.	Select a list that contains songs.
Not Found	No related songs.	Transfer songs to the iPod.

iTunes tagging

Message	Cause	Action
iPod full. Tags not transferred.	Memory used for tag information on the iPod is full.	Sync the iPod with iTunes and clean up the tagged playlist.
Memory full. Tags not stored. Connect iPod.	This unit's flash memory used as the temporary storage area is full.	The tag information on this unit is transferred to the iPod automatically when an iPod is connected.
Tag transfer failed. Reconnect your iPod.	This unit's tag information cannot transfer to the iPod.	Check the iPod and try again.
Tag store failed.	Tag information cannot be stored in this unit.	Try again.
Error-8D	Built-in FLASH ROM encountered an error	Turn the ignition OFF or ON.
Already stored	This tag information is already stored in memory.	Tag information can only be saved once for any given song. Tag information cannot be saved for the same song more than once.

Additional information

Bluetooth

Message	Cause	Action
Error-10	The power failed for the Bluetooth module of this unit.	Turn the ignition switch OFF and then to ACC or ON. If the error message is still displayed after performing the above action, please contact your dealer or an authorized Pioneer Service Station.



Understanding auto EQ error messages

When correct measurement of the car's interior acoustic characteristics is not possible using auto EQ, an error message may appear on the display. In such cases, refer to the table below to see what the problem is and how it may be corrected. After checking, try again.

Message	Cause	Action
Please connect the microphone for measurement. When finished, please push HOME key.	The microphone is not connected.	Plug the optional microphone securely into the jack.
Error. Please check xxxx speaker.	The microphone cannot pick up the measuring tone of a speaker.	<ul style="list-style-type: none"> • Confirm that the speakers are connected correctly. • Correct the input level setting of the power amp connected to the speakers. • Plug the microphone securely into the jack.

Message	Cause	Action
Error. Please check noise.	The surrounding noise level is too high.	<ul style="list-style-type: none"> • Stop your car in a place that is quiet, and switch off the engine, air conditioner and heater. • Set the microphone correctly.
Error. Please check battery.	Power is not being supplied from the battery to this unit.	<ul style="list-style-type: none"> • Connect the battery correctly. • Check the battery voltage.



Understanding messages

Messages	Translation
Screen image may appear reversed.	Pioneer recommends the use of a camera which outputs mirror-reversed images. Otherwise, the screen image will appear reversed.



Additional information

Indicator list

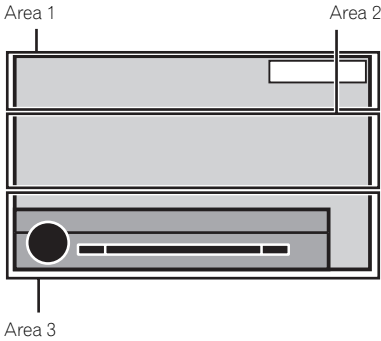

Area 1



Indicates that the volume is adjusted.



Indicates that the mute function is on.



Indicates that the sound is attenuated.

Area 2



Shows when downloadable song information (tag) from a radio station is received.

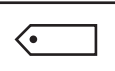

Shows when song information (tag) from a radio station is being saved to this unit.



Indicates that the digital format is Dolby Digital.



Indicates that the digital format is MPEG Audio.



Indicates that the digital format is Linear PCM.

48k16

Indicates the sampling frequency.

DTS

Indicates that the digital format is DTS.

1 ch

1+1ch

2 ch

Multi ch

Indicates the audio channel.

PBC On

Indicates that a disc with PBC On is being played.



- Indicates that a cellular phone is connected.
- Indicates that an incoming call has been received and has not been checked yet.



Indicates the battery strength of the cellular phone.

- The level shown on the indicator may differ from the actual battery strength.
- If the battery strength is not available, nothing is displayed in the battery strength indicator area.



Indicates that the connected Bluetooth device only supports Bluetooth telephone.



























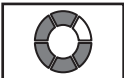

Indicates that the connected Bluetooth device only supports Bluetooth audio.



Show the album title when receiving the tag information.
Shows the album title of the song currently being played for MP3/WMA/AAC/WAV files.

Additional information

	Shows the song title when receiving the tag information. Shows the song title of the song currently being played for MP3/WMA/AAC/WAV files.		Shows the chapter number currently being played.
	Shows the comment currently being played.		Shows the genre of the track/song currently being played.
	Shows the station name currently tuned in to.	Area 3	
	Shows the artist name when receiving the tag information. Shows the artist name of the artist currently being played for MP3/WMA/AAC/WAV files.		Shows when radio signal is received.
	Shows cellular phone information.		Indicates that the selected frequency is being broadcast in stereo.
	Shows general phone information.		Touch to turn BSM on.
	Shows home phone information.		Indicates that Auto EQ is on.
	Shows office phone information.		Shows when this unit has the song information (tag).
	Shows other phone information.		Indicates that the unit is currently processing an operation such as search.
	Shows the folder name of the folder containing the MP3/WMA/AAC file currently being played.		Shows when creating the database in Music browse mode.
	Shows the file name of the MP3/WMA/AAC file currently being played.		Shows when saving the database in Music browse mode.
	Shows the preset number of the station currently being tuned in to.		Indicates the signal strength of the cellular phone.
	Shows the title number currently being played.		Indicates that a Bluetooth telephone is connected.
			Indicates that TA (traffic announcement standby) is on.
			Indicates that the news program interruption is on.



Additional information

Handling guidelines

Discs and player

Use discs featuring any of the following logos.



Use 12-cm discs. Do not use 8-cm discs or an adapter for 8-cm discs.

Use only conventional, fully circular discs. Do not use shaped discs.



Do not insert anything other than a DVD-R/RW or CD-R/RW into the disc loading slot.

Do not use cracked, chipped, warped, or otherwise damaged discs as they may damage the player.

Unfinalized CD-R/RW discs cannot be played back.

Do not touch the recorded surface of the discs.

Store discs in their cases when not in use.

Do not attach labels, write on or apply chemicals to the surface of the discs.

To clean a disc, wipe the disc with a soft cloth outward from the center.

Condensation may temporarily impair the player's performance. Let it rest for about one hour to adjust to a warmer temperature. Also, wipe any damp discs off with a soft cloth.

Playback of discs may not be possible because of disc characteristics, disc format, recorded application, playback environment, storage conditions, and so on.

Road shocks may interrupt disc playback.

Certain functions may not be available for some DVD video discs.

It may not be possible to play back some DVD video discs.

It is not possible to play back DVD-RAM discs.

This unit is not compatible with discs recorded in AVCHD (Advanced Video Codec High Definition) format. Do not insert AVCHD discs as you may not be able to eject the disc.

When using discs that can be printed on label surfaces, check the instructions and the warnings of the discs. Depending on the discs, inserting and ejecting may not be possible. Using such discs may result in damage to this equipment.

Do not attach commercially available labels or other materials to the discs.

- The discs may warp making the disc unplayable.
- The labels may come off during playback and prevent ejection of the discs, which may result in damage to the equipment.

External storage device (USB)

Depending on the external storage device (USB), the following problems may occur.

- Operations may vary.
- The storage device may not be recognized.
- Files may not be played back properly.

USB storage device

Connections via USB hub are not supported.

Do not connect anything other than a USB storage device.

Firmly secure the USB storage device when driving. Do not let the USB storage device fall onto the floor, where it may become jammed under the brake or accelerator pedal.

Depending on the USB storage device, the device may cause noise to occur in the radio.

Copyright protected files that are stored in the USB devices cannot be played back.

You cannot connect a USB portable audio player/USB memory to this unit via USB hub.

Partitioned USB memory is not compatible with this unit.

Additional information

Depending on the kind of USB portable audio player/USB memory you use, the device may not be recognized or audio files may not be played back properly.

Do not leave the USB portable audio player/USB memory in direct sunlight for extended amounts of time. Doing so may cause the device to malfunction from the extreme rise in temperature.

iPod

To ensure proper operation, connect the dock connector cable from the iPod directly to this unit.

Firmly secure the iPod when driving. Do not let the iPod fall onto the floor, where it may become jammed under the brake or accelerator pedal.

About iPod settings

- When an iPod is connected, this unit changes the EQ (equalizer) setting of the iPod to off in order to optimize the acoustics. When you disconnect the iPod, the EQ returns to the original setting.
- You cannot set Repeat to off on the iPod when using this unit. Repeat is automatically changed to All when the iPod is connected to this unit.

Incompatible text saved on the iPod will not be displayed by the unit.

DVD-R/RW discs

Unfinalized DVD-R/RW discs which have been recorded in the Video format (video mode) cannot be played back.

Playback of DVD-R/RW discs may not be possible, due to disc characteristics, scratches or dirt on the disc, or dirt, condensation, etc. on the lens of this unit.

Depending on the application settings and the environment, playback of discs recorded on a personal computer may not be possible. (For details, contact the manufacturer of the application.)

CD-R/RW discs

When CD-R/RW discs are used, playback is possible only for discs which have been finalized.

Playback of CD-R/RW discs recorded on a music CD recorder or a personal computer may not be possible due to disc characteristics, scratches or dirt on the disc, or dirt, condensation, etc., on the lens of this unit.

Depending on the application settings and the environment, playback of discs recorded on a personal computer may not be possible. (For details, contact the manufacturer of the application.)

Playback of CD-R/RW discs may become impossible in case of direct exposure to sunlight, high temperatures, or the storage conditions in the vehicle.

Titles and other text information recorded on a CD-R/RW disc may not be displayed by this unit (in the case of audio data (CD-DA)).

DualDiscs

DualDiscs are two-sided discs that have a recordable CD for audio on one side and a recordable DVD for video on the other.

Playback of the DVD side is possible with this unit. However, since the CD side of DualDiscs is not physically compatible with the general CD standard, it may not be possible to play the CD side with this unit. Frequent loading and ejecting of a DualDisc may result in scratches on the disc. Serious scratches can lead to playback problems on this unit. In some cases, a DualDisc may become stuck in the disc loading slot and will not eject. To prevent this, we recommend you refrain from using DualDisc with this unit. Please refer to the information from the disc manufacturer for more detailed information about DualDiscs.

JPEG picture files

JPEG is short for Joint Photographic Experts Group and refers to a still image compression technology standard.

Files are compatible with Baseline JPEG and EXIF 2.1 still images up to a resolution of 8 192 × 7 680. (EXIF format is used most commonly with digital still cameras.)

Playback of EXIF format files that were processed by a personal computer may not be possible.

There is no progressive JPEG compatibility.

DivX video files

Depending on the composition of the file information, such as the number of audio streams or file size, there may be a slight delay when playing back discs.

Some special operations may be prohibited due to the composition of the DivX files.

Additional information

Only DivX files downloaded from a DivX partner site are guaranteed for proper operation. Unauthorized DivX files may not operate properly.

DRM rental files cannot be operated until playback is started.

Recommended file size: 2 GB or less with a transmission rate of 2 Mbps or less.

The ID code of this unit must be registered to a DivX VOD provider in order to playback DivX VOD files. For information on ID codes, refer to *Displaying the DivX® VOD registration code* on page 59.

For more details about DivX, visit the following site: <http://www.divx.com/>

MPEG-1/MPEG-2/MPEG-4 video files

Elapsed playback time may not be displayed correctly.

Important

- When naming a JPEG image file, add the corresponding file name extension (.jpg, .jpeg or .jpe).
- This unit plays back files with these file name extensions (.jpg, .jpeg or .jpe) as a JPEG image file. To prevent malfunctions, do not use these extensions for files other than JPEG image files. 

Compressed audio compatibility (USB)

WAV

File extension: .wav

Quantization bits: 8 and 16 (LPCM), 4 (MS ADPCM)

Sampling frequency: 16 kHz to 48 kHz (LPCM), 22.05 kHz and 44.1 kHz (MS ADPCM)



Compressed audio compatibility (disc, USB)

WMA

File extension: .wma

Bit rate: 48 kbps to 320 kbps (CBR), VBR

Sampling frequency: 32 kHz to 48 kHz

Windows Media™ Audio Professional, Lossless, Voice/DRM Stream/Stream with video: Not compatible

MP3

File extension: .mp3

Bit rate: 8 kbps to 320 kbps (CBR), VBR

Sampling frequency: 8 kHz to 48 kHz (32 kHz, 44.1 kHz, 48 kHz for emphasis)

Compatible ID3 tag version: 1.0, 1.1, 2.2, 2.3, 2.4 (ID3 tag Version 2.x is given priority over Version 1.x.)

M3u playlist: Not compatible

MP3i (MP3 interactive), mp3 PRO: Not compatible

AAC

Compatible format: AAC encoded by iTunes

File extension: .m4a

Sampling frequency: 11.025 kHz to 48 kHz

Bit rate: 16 kbps to 320 kbps

Apple Lossless: Not compatible

AAC file bought from the iTunes Store (.m4p file extension): Not compatible

DivX compatibility

Compatible format: DivX video format implemented in relation to DivX standards

File extensions: .avi or .divx

DivX Ultra format: Not compatible

DivX HD format: Not compatible

DivX files without video data: Not compatible

DivX plus: Not compatible

Additional information

Compatible audio codec: MP2, MP3, Dolby Digital

LPCM: Compatible

Bit rate: 8 kbps to 320 kbps (CBR), VBR

Sampling frequency: 8 kHz to 48 kHz

Compatible external subtitle file extension: .srt

MPEG-1/MPEG-2/MPEG-4 video

File extensions: .mpg or .mpeg (MPEG-1/MPEG-2), .avi (MPEG-4)

Compatible audio codec: MP2 (MPEG-1/MPEG-2), MP2, MP3, Dolby Digital (MPEG-4)

H.264 (MPEG-4AVC): Compatible

LPCM: Not compatible

Bit rate: 8 kbps to 320 kbps (CBR), VBR

Sampling frequency: 8 kHz to 48 kHz

Supplemental information

Some characters in a file name (including the file extension) or a folder name may not be displayed.

This unit may not work properly depending on the application used to encode WMA files.

There may be a slight delay at the start of playback of audio files embedded with image data or audio files stored on a USB storage device that has numerous folder hierarchies.

Disc (CD/DVD)

Playable folders: up to 99 for CD-R/RW

Playable folders: up to 700 for DVD-R/RW

Playable files: up to 999 for CD-R/RW

Playable files: up to 3500 for DVD-R/RW

File system: ISO 9660 Level 1 and 2, Romeo, Joliet, UDF 1.02 (DVD-R/RW)

Multi-session playback: Compatible

Packet write data transfer: Not compatible

Regardless of the length of blank sections between the songs from the original recording, compressed audio discs play with a short pause between songs.

External storage device (USB)

Playable folders: up to 1 500 (up to 700 for DivX/MPEG-1/MPEG-2/MPEG-4)

Playable files: up to 15 000

Playback of copyright-protected files: Not compatible

Partitioned external storage device (USB): Only the first playable partition can be played.

There is no compatibility for Multi Media Cards (MMC).

CAUTION

- Pioneer accepts no responsibility for data lost on the USB memory/USB portable audio player even if that data is lost while using this unit.
- Pioneer cannot guarantee compatibility with all USB mass storage devices and assumes no responsibility for any loss of data on media players, smart phones, or other devices while using this product.
- Do not leave the discs/external storage device (USB) or iPod in places with high temperatures. 

iPod compatibility

This unit supports only the following iPod models. Supported iPod software versions are shown below. Older versions may not be supported.

Made for

- iPod touch 5th generation (software version 6.0.1)
- iPod touch 4th generation (software version 5.1.1)
- iPod touch 3rd generation (software version 5.1.1)
- iPod touch 2nd generation (software version 4.2.1)
- iPod touch 1st generation (software version 3.1.3)
- iPod classic 160GB (software version 2.0.4)
- iPod classic 120GB (software version 2.0.1)

Additional information

- iPod classic (software version 1.1.2)
- iPod with video (software version 1.3)
- iPod nano 7th generation (software version 1.0.1)
- iPod nano 6th generation (software version 1.2)
- iPod nano 5th generation (software version 1.0.2)
- iPod nano 4th generation (software version 1.0.4)
- iPod nano 3rd generation (software version 1.1.3)
- iPod nano 2nd generation (software version 1.1.3)
- iPod nano 1st generation (software version 1.3.1)
- iPhone 5 (software version 6.0.1)
- iPhone 4S (software version 5.1.1)
- iPhone 4 (software version 5.1.1)
- iPhone 3GS (software version 5.1.1)
- iPhone 3G (software version 4.2.1)
- iPhone (software version 3.1.3)

Depending on the generation or version of the iPod, some functions may not be available.

Operations may vary depending on the software version of iPod.

About the file/format compatibility, refer to the iPod manuals.

Audiobook, Podcast: Compatible

CAUTION

Pioneer accepts no responsibility for data lost on the iPod, even if that data is lost while this unit is used.

About iTunes tagging

This function can be performed with the following iPod models.

- iPod touch 4th generation
- iPod touch 3rd generation
- iPod touch 2nd generation
- iPod touch 1st generation
- iPod classic 160GB
- iPod classic 120GB

- iPod classic
- iPod with video
- iPod nano 6th generation
- iPod nano 5th generation
- iPod nano 4th generation
- iPod nano 3rd generation
- iPhone 4S
- iPhone 4
- iPhone 3GS
- iPhone 3G
- iPhone

The song information (tag) can be saved from the broadcasting station to your iPod. The songs will show up in a playlist called "Tagged playlist" in iTunes the next time you sync your iPod. Then you can directly buy the songs you want from the iTunes Store.

The tagged songs and the song that you can buy from the iTunes Store may be different. Make sure to confirm the song before you make the purchase.

If you cannot use this function normally, update your iPod firmware. 

Sequence of audio files

The user cannot assign folder numbers and specify playback sequences with this unit.

Example of a hierarchy

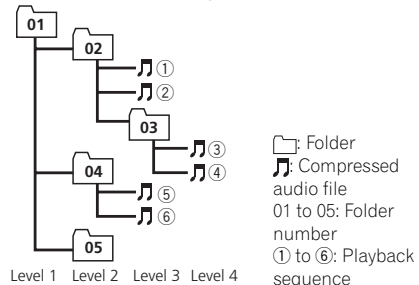

Disc

Folder selection sequence or other operation may differ depending on the encoding or writing software.

Additional information

External storage device (USB)

The playback sequence is the same as the recorded sequence in the external storage device (USB).

To specify the playback sequence, the following method is recommended.

- 1 Create a file name that includes numbers that specify the playback sequence (e.g., 001xxx.mp3 and 099yyy.mp3).
- 2 Put those files into a folder.
- 3 Save the folder that contains the files to the external storage device (USB).

However, depending on the system environment, you may not be able to specify the playback sequence.

For USB portable audio players, the sequence is different and depends on the player. 

Using the display correctly

CAUTION

- If liquid or foreign matter should get inside this unit, turn off the power immediately and consult your dealer or the nearest authorized PIONEER Service Station. Do not use the unit in this condition because doing so may result in fire, electric shock, or other failure.
- If you notice smoke, a strange noise or smell, or any other abnormal signs from the display, turn off the power immediately and consult your dealer or the nearest authorized PIONEER Service Station. Using this unit in this condition may result in permanent damage to the system.
- Do not disassemble or modify this unit, as there are high-voltage components inside which may cause electric shock. Be sure to consult your dealer or the nearest authorized PIONEER Service Station for internal inspection, adjustments, or repairs.

Handling the display

- Never touch the screen with anything besides your finger when operating the touch

panel function. The screen can scratch easily.

- When the display is subjected to direct sunlight for a long period of time, it will become very hot resulting in possible damage to the LCD screen. You should avoid exposing the display unit to direct sunlight as much as possible.
- The display should be used within the temperature range of -10°C to $+60^{\circ}\text{C}$. At temperatures higher or lower than this operating temperature range, the display may not operate normally.
- The LCD screen is exposed in order to increase its visibility within the vehicle. Do not press it strongly on it as this may damage it.
- Do not push the LCD screen forcefully as this may scratch it.

Liquid crystal display (LCD) screen

- Heat from the heater may damage the LCD screen, and cool air from the cooler may cause moisture to form inside the display resulting in possible damage.
- Small black dots or white dots (bright dots) may appear on the LCD screen. These are due to the characteristics of the LCD screen and do not indicate a malfunction.
- When using a cellular phone, keep the antenna away from the display to prevent disruption of the video image by the appearance of spots, colored stripes, etc.

LED (light-emitting diode) backlight

- At low temperatures, using the LED backlight may increase image lag and degrade the image quality due to the characteristics of the LCD screen. Image quality will improve with an increase in temperature.
- To protect the LED backlight, the display will darken in the following environments:
 - In the direct sunlight
 - Near the heater vent

Additional information

- The product lifetime of the LED backlight is more than 10 000 hours. However, it may decrease if used in high temperatures.
- If the LED backlight reaches the end of its product lifetime, the screen will become dark and the image will no longer be projected. In such cases, please consult your dealer or the nearest authorized PIONEER Service Station.

Keeping the display in good condition

- When removing dust from the screen or cleaning the display, first turn the system power off, then wipe with a soft dry cloth.
- When wiping the screen, take care not to scratch the surface. Do not use harsh or abrasive chemical cleaners.

Bluetooth profiles

In order to use Bluetooth wireless technology, devices must be able to interpret certain profiles. This unit is compatible with the following profiles.

- GAP (Generic Access Profile)
- SDP (Service Discovery Protocol)
- OPP (Object Push Profile)
- HFP (Hands Free Profile)
- HSP (Head Set Profile)
- PBAP (Phone Book Access Profile)
- A2DP (Advanced Audio Distribution Profile)
- AVRCP (Audio/Video Remote Control Profile) 1.3

License, Warranty Disclaimer & Limitation of Liability

This item incorporates copy protection technology that is protected by U.S. patents and other intellectual property rights of Rovi Corporation. Reverse engineering and disassembly are prohibited.

SAFETY PROVISIONS

Bluetooth

The *Bluetooth*[®] word mark and logos are registered trademarks owned by Bluetooth SIG, Inc. and any use of such marks by PIONEER CORPORATION is under license. Other trademarks and trade names are those of their respective owners.

DVD video

DVD is a trademark of DVD Format/Logo Licensing Corporation.

iTunes

Apple and iTunes are trademarks of Apple Inc., registered in the U.S. and other countries.

MP3

Supply of this product only conveys a license for private, non-commercial use and does not convey a license nor imply any right to use this product in any commercial (i.e. revenue-generating) real time broadcasting (terrestrial, satellite, cable and/or any other media), broadcasting/streaming via internet, intranets and/or other networks or in other electronic content distribution systems, such as pay-audio or audio-on-demand applications. An independent license for such use is required. For details, please visit <http://www.mp3licensing.com>.

WMA

Windows Media is either a registered trademark or trademark of Microsoft Corporation in the United States and/or other countries. This product includes technology owned by Microsoft Corporation and cannot be used or distributed without a license from Microsoft Licensing, Inc.

iPod & iPhone

iPhone, iPod, iPod classic, iPod nano, and iPod touch are trademarks of Apple Inc., registered in the U.S. and other countries. Lightning is a trademark of Apple Inc.

Additional information

“Made for iPod” and “Made for iPhone” mean that an electronic accessory has been designed to connect specifically to iPod or iPhone, respectively, and has been certified by the developer to meet Apple performance standards. Apple is not responsible for the operation of this device or its compliance with safety and regulatory standards. Please note that the use of this accessory with iPod or iPhone may affect wireless performance.

Dolby Digital

Manufactured under license from Dolby Laboratories. Dolby and the double-D symbol are trademarks of Dolby Laboratories.

DivX

DivX®, DivX Certified® and associated logos are trademarks of Rovi Corporation or its subsidiaries and are used under license.

ABOUT DIVX VIDEO: DivX® is a digital video format created by DivX, LLC, a subsidiary of Rovi Corporation. This is an official DivX Certified® device that plays DivX video. Visit divx.com for more information and software tools to convert your files into DivX videos.

ABOUT DIVX VIDEO-ON-DEMAND: This DivX Certified® device must be registered in order to play purchased DivX Video-on-Demand (VOD) movies. To obtain your registration code, locate the DivX VOD section in *Displaying the DivX® VOD registration code*. Go to vod.divx.com for more information on how to complete your registration.

MIXTRAX

MIXTRAX is a trademark of the PIONEER CORPORATION.

libpng

Please be aware in advance that Pioneer will not respond to questions concerning the contents of the source code.

This licence was originally written in English and translated here only to help the reader understand its content. Therefore, please note that translated licence is NOT legally identified with the original English text.

This copy of the libpng notices is provided for your convenience. In case of any discrepancy between this copy and the notices in the file `png.h` that is included in the libpng distribution, the latter shall prevail.

COPYRIGHT NOTICE, DISCLAIMER, and LICENSE:

If you modify libpng you may insert additional notices immediately following this sentence. This code is released under the libpng license. libpng versions 1.2.6, August 15, 2004, through 1.5.0, January 6, 2011, are Copyright (c) 2004, 2006-2010 Glenn Randers-Pehrson, and are distributed according to the same disclaimer and license as libpng-1.2.5 with the following individual added to the list of Contributing Authors

Cosmin Truta

libpng versions 1.0.7, July 1, 2000, through 1.2.5 - October 3, 2002, are Copyright (c) 2000-2002 Glenn Randers-Pehrson, and are distributed according to the same disclaimer and license as libpng-1.0.6 with the following individuals added to the list of Contributing Authors

Simon-Pierre Cadieux

Eric S. Raymond

Gilles Vollant

and with the following additions to the disclaimer:

There is no warranty against interference with your enjoyment of the library or against infringement. There is no warranty that our efforts or the library will fulfill any of your particular purposes or needs. This library is provided with all faults, and the entire risk of satisfactory quality, performance, accuracy, and effort is with the user.

libpng versions 0.97, January 1998, through 1.0.6, March 20, 2000, are Copyright (c) 1998, 1999 Glenn Randers-Pehrson, and are distributed according to the same disclaimer and license as libpng-0.96, with the following individuals added to the list of Contributing Authors:

Additional information

Tom Lane

Glenn Randers-Pehrson

Willem van Schaik

libpng versions 0.89, June 1996, through 0.96, May 1997, are Copyright (c) 1996, 1997 Andreas Dilger Distributed according to the same disclaimer and license as libpng-0.88, with the following individuals added to the list of Contributing Authors:

John Bowler

Kevin Bracey

Sam Bushell

Magnus Holmgren

Greg Roelofs

Tom Tanner

libpng versions 0.5, May 1995, through 0.88, January 1996, are Copyright (c) 1995, 1996 Guy Eric Schalnat, Group 42, Inc.

For the purposes of this copyright and license, "Contributing Authors" is defined as the following set of individuals:

Andreas Dilger

Dave Martindale

Guy Eric Schalnat

Paul Schmidt

Tim Wegner

The PNG Reference Library is supplied "AS IS". The Contributing Authors and Group 42, Inc. disclaim all warranties, expressed or implied, including, without limitation, the warranties of merchantability and of fitness for any purpose. The Contributing Authors and Group 42, Inc. assume no liability for direct, indirect, incidental, special, exemplary, or consequential damages, which may result from the use of the PNG Reference Library, even if advised of the possibility of such damage.

Permission is hereby granted to use, copy, modify, and distribute this source code, or portions hereof, for any purpose, without fee, subject to the following restrictions:

1. The origin of this source code must not be misrepresented.
2. Altered versions must be plainly marked as such and must not be misrepresented as being the original source.

3. This Copyright notice may not be removed or altered from any source or altered source distribution.

The Contributing Authors and Group 42, Inc. specifically permit, without fee, and encourage the use of this source code as a component to supporting the PNG file format in commercial products. If you use this source code in a product, acknowledgment is not required but would be appreciated.

A "png_get_copyright" function is available, for convenient use in "about" boxes and the like: `printf("%s",png_get_copyright(NULL));` Also, the PNG logo (in PNG format, of course) is supplied in the files "pngbar.png" and "pngbar.jpg (88x31) and "pngnow.png" (98x31). Libpng is OSI Certified Open Source Software. OSI Certified Open Source is a certification mark of the Open Source Initiative. Glenn Randers-Pehrson glennrp at users.sourceforge.net January 6, 2011 

Additional information

Language code chart for DVD

Language (code), input code

Japanese (ja), 1001	Dzongkha (dz), 0426	Kurdish (ku), 1121	Kinyarwanda (rw), 1823
English (en), 0514	Ewe (ee), 0505	Komi (kv), 1122	Sanskrit (sa), 1901
French (fr), 0618	Esperanto (eo), 0515	Cornish (kw), 1123	Sardinian (sc), 1903
Spanish (es), 0519	Estonian (et), 0520	Kirghiz, Kyrgyz (ky), 1125	Sindhi (sd), 1904
German (de), 0405	Basque (eu), 0521	Latin (la), 1201	Northern Sami (se), 1905
Italian (it), 0920	Persian (fa), 0601	Luxembourghish (lb), 1202	Sangho (sg), 1907
Chinese (zh), 2608	Fulah (ff), 0606	Ganda (lg), 1207	Sinhala (si), 1909
Dutch, Flemish (nl), 1412	Finnish (fi), 0609	Limburgan (li), 1209	Slovak (sk), 1911
Portuguese (pt), 1620	Fijian (fj), 0610	Lingala (ln), 1214	Slovenian (sl), 1912
Swedish (sv), 1922	Faroese (fo), 0615	Lao (lo), 1215	Samoan (sm), 1913
Russian (ru), 1821	Western Frisian (fy), 0625	Lithuanian (lt), 1220	Shona (sn), 1914
Korean (ko), 1115	Irish (ga), 0701	Luba-Katanga (lu), 1221	Somali (so), 1915
Greek (el), 0512	Gaelic (gd), 0704	Latvian (lv), 1222	Albanian (sq), 1917
Afar (aa), 0101	Galician (gl), 0712	Malagasy (mg), 1307	Serbian (sr), 1918
Abkhazian (ab), 0102	Guarani (gn), 0714	Marshallese (mh), 1308	Swati (ss), 1919
Avestan (ae), 0105	Gujarati (gu), 0721	Maori (mi), 1309	Sotho, Southern (st), 1920
Afrikaans (af), 0106	Manx (gv), 0722	Macedonian (mk), 1311	Sundanese (su), 1921
Akan (ak), 0111	Hausa (ha), 0801	Malayalam (ml), 1312	Swahili (sw), 1923
Amharic (am), 0113	Hebrew (he), 0805	Mongolian (mn), 1314	Tamil (ta), 2001
Aragonese (an), 0114	Hindi (hi), 0809	Marathi (mr), 1318	Telugu (te), 2005
Arabic (ar), 0118	Hiri Motu (ho), 0815	Malay (ms), 1319	Tajik (tg), 2007
Assamese (as), 0119	Croatian (hr), 0818	Maltese (mt), 1320	Thai (th), 2008
Avaric (av), 0122	Haitian (ht), 0820	Burmese (my), 1325	Tigrinya (ti), 2009
Aymara (ay), 0125	Hungarian (hu), 0821	Nauru (na), 1401	Turkmen (tk), 2011
Azerbaijani (az), 0126	Armenian (hy), 0825	Bokmal (nb), 1402	Tagalog (tl), 2012
Bashkir (ba), 0201	Herero (hz), 0826	Ndebele, North (nd), 1404	Tswana (tn), 2014
Belarusian (be), 0205	Interlingua (ia), 0901	Nepali (ne), 1405	Tonga (to), 2015
Bulgarian (bg), 0207	Indonesian (id), 0904	Ndonga (ng), 1407	Turkish (tr), 2018
Bihari (bh), 0208	Interlingue (ie), 0905	Nynorsk (nn), 1414	Tsonga (ts), 2019
Bislama (bi), 0209	Igbo (ig), 0907	Norwegian (no), 1415	Tatar (tt), 2020
Bambara (bm), 0213	Sichuan Yi (ii), 0909	Ndebele, South (nr), 1418	Twi (tw), 2023
Bengali (bn), 0214	Inupiaq (ik), 0911	Navajo, Navaho (nv), 1422	Tahitian (ty), 2025
Tibetan (bo), 0215	Ido (io), 0915	Chichewa (ny), 1425	Uighur, Uygur (ug), 2107
Breton (br), 0218	Icelandic (is), 0919	Occitan (oc), 1503	Ukrainian (uk), 2111
Bosnian (bs), 0219	Inuktitut (iu), 0921	Ojibwa (oj), 1510	Urdu (ur), 2118
Catalan (ca), 0301	Javanese (jv), 1022	Oromo (om), 1513	Uzbek (uz), 2126
Chechen (ce), 0305	Georgian (ka), 1101	Oriya (or), 1518	Venda (ve), 2205
Chamorro (ch), 0308	Kongo (kg), 1107	Ossetian (os), 1519	Vietnamese (vi), 2209
Corsican (co), 0315	Kikuyu, Gikuyu (ki), 1109	Panjabi, Punjabi (pa), 1601	Volapük (vo), 2215
Cree (cr), 0318	Kuanyama (kj), 1110	Pali (pi), 1609	Walloon (wa), 2301
Czech (cs), 0319	Kazakh (kk), 1111	Polish (pl), 1612	Wolof (wo), 2315
Church Slavonic (cu), 0321	Kalaallisut (kl), 1112	Pashto, Pushto (ps), 1619	Xhosa (xh), 2408
Chuvash (cv), 0322	Central Khmer (km), 1113	Quechua (qu), 1721	Yiddish (yi), 2509
Welsh (cy), 0325	Kannada (kn), 1114	Romansh (rm), 1813	Yoruba (yo), 2515
Danish (da), 0401	Kanuri (kr), 1118	Rundi (rn), 1814	Zhuang, Chuang (za), 2601
Divehi (dv), 0422	Kashmiri (ks), 1119	Romanian (ro), 1815	Zulu (zu), 2621



Additional information

Specifications

General

Rated power source	14.4 V DC (allowable voltage range: 10.8 V to 15.1 V DC)
Grounding system	Negative type
Maximum current consumption	10.0 A
Dimensions (W × H × D): DIN	
Chassis	178 mm × 100 mm × 157 mm
Nose	188 mm × 118 mm × 26 mm
(AVH-X5500BT)	
Nose	188 mm × 118 mm × 17 mm
(AVH-X3500DAB/AVH-X2500BT/AVH- X1500DVD)	
D	
Chassis	178 mm × 100 mm × 165 mm
Nose	171 mm × 97 mm × 18 mm
(AVH-X5500BT)	
Nose	171 mm × 97 mm × 9 mm
(AVH-X3500DAB/AVH-X2500BT/AVH- X1500DVD)	
Weight	2.0 kg
(AVH-X5500BT)	
Weight	1.7 kg
(AVH-X3500DAB/AVH-X2500BT/AVH-X1500DVD)	

Display

Screen size/aspect ratio	6.95 inch wide/16:9 (effective display area: 156.6 mm × 81.6 mm)
(AVH-X5500BT)	
Screen size/aspect ratio	6.1 inch wide/16:9 (effective display area: 136.2 mm × 72.0 mm)
(AVH-X3500DAB/AVH-X2500BT/AVH-X1500DVD)	
Pixels	1 152 000 (2 400 × 480)
Display method	TFT active matrix, driving type
Color system	NTSC/PAL/PAL-M/PAL-N/ SECAM compatible
Durable temperature range (power off)	-20 °C to +80 °C

Audio

Maximum power output	50 W × 4 70 W × 1/2 Ω (for subwoofer)
----------------------------	--

Continuous power output	22 W × 4 (50 Hz to 15 000 Hz, 5% THD, 4 Ω load, both channels driven)
Load impedance	4 Ω (4 Ω to 8 Ω (2 Ω for 1 ch) allowable)
Preout maximum output level	4.0 V
(AVH-X5500BT)	
Preout maximum output level	2.0 V
(AVH-X3500DAB/AVH-X2500BT/AVH-X1500DVD)	
Equalizer (8-Band Graphic Equalizer):	
Frequency	40 Hz/80 Hz/200 Hz/400 Hz/ 1 kHz/2.5 kHz/8 kHz/10 kHz
Gain	±12 dB
HPF:	
Frequency	50 Hz/63 Hz/80 Hz/100 Hz/ 125 Hz
Slope	-12 dB/oct
Subwoofer (mono):	
Frequency	50 Hz/63 Hz/80 Hz/100 Hz/ 125 Hz
Slope	-18 dB/oct
Gain	+6 dB to -24 dB
Phase	Normal/Reverse
Bass boost:	
Gain	+12 dB to 0 dB

DVD Player

System	DVD video, Video CD, CD, WMA, MP3, AAC, DivX, JPEG, MPEG player
Usable discs	DVD video, Video CD, CD, CD-R/RW, DVD-R/RW/R DL
Region number	2
Frequency response	5 Hz to 44 000 Hz (with DVD, at sampling frequency 96 kHz)
Signal-to-noise ratio	96 dB (1 kHz) (IEC-A net- work) (RCA level)
Output level:	
Video	1.0 Vp-p/75 Ω (±0.2 V)
Number of channels	2 (stereo)
MP3 decoding format	MPEG-1 & 2 Audio Layer 3
WMA decoding format	Ver. 7, 7.1, 8, 9, 10, 11, 12 (2 ch audio) (Windows Media Player)
AAC decoding format	MPEG-4 AAC (iTunes en- coded only) (.m4a) (Ver. 10.6 and earlier)
JPEG:	
JPEG decoding formatjpeg, .jpg, .jpe

Additional information

Pixel Sampling	4:2:2, 4:2:0
Decode Size	MAX:8 192(H) x 7 680(W), MIN:32(H) x 32(W)
DivX decoding format	Home Theater Ver. 3, 4, 5, 2, 6 (Except ultra and HD) (.avi, .divx)
MPEG video decoding format	MPEG1, MPEG2, MPEG4

USB

USB standard specification	USB 1.1, USB 2.0 full speed (For video files) USB 2.0 high speed (For audio files)
Maximum current supply	1.0 A
USB Class	MSC (Mass Storage Class)
File system	FAT16, FAT32
MP3 decoding format	MPEG-1 & 2 Audio Layer 3
WMA decoding format	Ver. 7, 7.1, 8, 9, 10, 11, 12 (2 ch audio) (Windows Media Player)
AAC decoding format	MPEG-4 AAC (iTunes en- coded only) (Ver. 10.6 and earlier)

WAV:

WAV signal format	Linear PCM, MS ADPCM (.wav)
Sampling Frequency	Linear PCM:16 kHz, 22.05 kHz, 24 kHz, 32 kHz, 44.1 kHz, 48 kHz MS ADPCM:22.05 kHz, 44.1 kHz

JPEG:

JPEG decoding formatjpeg, .jpg, .jpe
Pixel Sampling	4:2:2, 4:2:0
Decode Size	MAX:8 192(H) x 7 680(W), MIN:32(H) x 32(W)
DivX decoding format	Home Theater Ver. 3, 4, 5, 2, 6 (Except ultra and HD) (.avi, .divx)
MPEG video decoding format	MPEG1, MPEG2, MPEG4

FM tuner

Frequency range	87.5 MHz to 108.0 MHz
Usable sensitivity	9 dBf (0.8 μ V/75 Ω mono, S/N: 30 dB)
Signal-to-noise ratio	72 dB (IEC-A network)

MW tuner

Frequency range	531 kHz to 1 602 kHz (9 kHz)
Usable sensitivity	25 μ V (S/N: 20 dB)

Signal-to-noise ratio	62 dB (IEC-A network)
-----------------------------	-----------------------

LW tuner

Frequency range	153 kHz to 281 kHz
Usable sensitivity	28 μ V (S/N: 20 dB)
Signal-to-noise ratio	62 dB (IEC-A network)

DAB tuner

(AVH-X3500DAB)	
Frequency range (Band III)	174.928 MHz to 239.200 MHz (5A to 13F)
Frequency range (L Band) ...	1 452.960 MHz to 1 490.624 MHz (LA to LW)
Usable sensitivity (Band III)	-90 dBm
Usable sensitivity (L Band)	-90 dBm
Signal-to-noise ratio	85 dB

Bluetooth

(AVH-X5500BT/AVH-X3500DAB/AVH-X2500BT)	
Version	Bluetooth 3.0 certified
Output power	+4 dBm Maximum (Power class 2)

Note

Specifications and the design are subject to modifications without notice. 

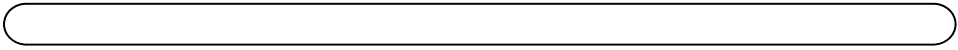

<http://www.pioneer.eu>

Visit **www.pioneer.co.uk** (or **www.pioneer.eu**) to register your product.

PIONEER CORPORATION

1-1, Shin-ogura, Saiwai-ku, Kawasaki-shi,
Kanagawa 212-0031, JAPAN

PIONEER ELECTRONICS (USA) INC.

P.O. Box 1540, Long Beach, California 90801-1540, U.S.A.
TEL: (800) 421-1404

PIONEER EUROPE NV

Haven 1087, Keetberglaan 1, B-9120 Melsele, Belgium/Belgique
TEL: (0) 3/570.05.11

PIONEER ELECTRONICS ASIACENTRE PTE. LTD.

253 Alexandra Road, #04-01, Singapore 159936
TEL: 65-6472-7555

PIONEER ELECTRONICS AUSTRALIA PTY. LTD.

5 Arco Lane, Heatherton, Victoria, 3202 Australia
TEL: (03) 9586-6300

PIONEER ELECTRONICS OF CANADA, INC.

340 Ferrier Street, Unit 2, Markham, Ontario L3R 2Z5, Canada
TEL: 1-877-283-5901
TEL: 905-479-4411

PIONEER ELECTRONICS DE MEXICO, S.A. de C.V.

Blvd.Manuel Avila Camacho 138 10 piso
Col.Lomas de Chapultepec, Mexico, D.F. 11000
TEL: 55-9178-4270

先鋒股份有限公司

台北市內湖區瑞光路407號8樓
電話：886-(0)2-2657-3588

先鋒電子（香港）有限公司

香港九龍長沙灣道909號5樓
電話：852-2848-6488

© 2012-2013 PIONEER CORPORATION.
All rights reserved.