

***Pioneer***

**VREC-DZ700DC**

DASH CAMERA

English

Owner's Manual

# Contents

Thank you for buying this Pioneer product.  
Please read through these instructions so you will know how to operate your model properly. After you have finished reading the instructions, keep this document in a safe place for future reference.

<b>Precaution</b> .....	<b>5</b>
Safety Precautions.....	5
<b>Disclaimer</b> .....	<b>8</b>
<b>How to read this Manual</b> .....	<b>9</b>
<b>Usage Precautions</b> .....	<b>10</b>
<b>Check the Accessories</b> .....	<b>12</b>
<b>Before Installing the Product</b> .....	<b>13</b>
Installation Precautions.....	13
Installation Tips.....	14
<b>Installation</b> .....	<b>15</b>
Specified Installation Position on Front Windscreen.....	15
Recommended Installation Position on Rear Windscreen.....	16
<b>Connecting the Power Cable</b> .....	<b>19</b>
<b>Part Names</b> .....	<b>21</b>
<b>Inserting and Ejecting the microSD Card</b> .....	<b>22</b>
Inserting the microSD Card.....	22
Ejecting the microSD Card.....	22
<b>Backing Up Recorded Files</b> .....	<b>23</b>
Folder and File Structure.....	23
<b>Using this product</b> .....	<b>24</b>
This product Power.....	24
System Indicator Display.....	24
Function Buttons.....	24
Status Display.....	25
Video Recording.....	26
Event Recording.....	26
Parking Mode.....	27
Photography Feature.....	28
Playing Recorded Files.....	28
<b>This Product Settings</b> .....	<b>30</b>
Configurable Features.....	32
<b>Guide to Recording Time and No. of Photos</b> .....	<b>34</b>
Guide to Recording Time When Fully Charged.....	34
<b>Exclusive App</b> .....	<b>35</b>
<b>Trademarks &amp; Copyrights</b> .....	<b>36</b>
<b>GPS</b> .....	<b>37</b>
<b>Troubleshooting</b> .....	<b>38</b>
<b>Specifications</b> .....	<b>39</b>

## Declaration of Conformity with regard to the Radio Equipment Directive 2014/53/EU

Manufacturer:

**Pioneer Corporation**

28-8, Honkomagome 2-chome, Bunkyo-ku,  
Tokyo 113-0021, JAPAN

EU Representative's & Importer:

**Pioneer Europe NV**

Haven 1087, Keetberglaan 1, 9120 Melsele, Belgium  
<https://www.pioneer-car.eu/eur/>

[\*] VREC-DZ700DC

English:

Hereby, Pioneer declares that the radio equipment type [\*] is in compliance with Directive 2014/53/EU.

The full text of the EU declaration of conformity is available at the following internet address:

<https://www.pioneer-car.eu/eur/compliance>

Suomi:

Pioneer vakuuttaa, että radiolaitetyyppi [\*] on direktiivin 2014/53/EU mukainen.

EU-vaatimustenmukaisuusvakuutuksen täysimittainen teksti on saatavilla seuraavassa internetosoitteessa:

<https://www.pioneer-car.eu/eur/compliance>

Nederlands:

Hierbij verklaar ik, Pioneer, dat het type radioapparatuur [\*] conform is met Richtlijn 2014/53/EU.

De volledige tekst van de EU-conformiteitsverklaring kan worden geraadpleegd op het volgende internetadres:

<https://www.pioneer-car.eu/eur/compliance>

Français:

Le soussigné, Pioneer, déclare que l'équipement radioélectrique du type [\*] est conforme à la directive 2014/53/UE.

Le texte complet de la déclaration UE de conformité est disponible à l'adresse internet suivante:

<https://www.pioneer-car.eu/eur/compliance>

Svenska:

Härmed försäkrar Pioneer att denna typ av radioutrustning [\*] överensstämmer med direktiv 2014/53/EU.

Den fullständiga texten till EU-försäkran om överensstämmelse finns på följande webbadress:

<https://www.pioneer-car.eu/eur/compliance>

Dansk:

Hermed erklærer Pioneer, at radioudstyrstypen [\*] er i overensstemmelse med direktiv 2014/53/EU.

EU-overensstemmelseserklæringens fulde tekst kan findes på følgende internetadresse:

<https://www.pioneer-car.eu/eur/compliance>

Deutsch:

Hiermit erkläre Pioneer, dass der Funkanlagentyp [Bezeichnung] der Richtlinie 2014/53/EU entspricht.

Der vollständige Text der EU-Konformitätserklärung ist unter der folgenden Internetadresse verfügbar:

<https://www.pioneer-car.eu/eur/compliance>

Ελληνικά:

Με την παρούσα ο/η Pioneer, δηλώνει ότι ο ραδιοεξοπλισμός [\*] πληροί την οδηγία 2014/53/ΕΕ.

Το πλήρες κείμενο της δήλωσης συμμόρφωσης ΕΕ διατίθεται στην ακόλουθη ιστοσελίδα στο διαδίκτυο:

<https://www.pioneer-car.eu/eur/compliance>

Italiano:

Il fabbricante, Pioneer, dichiara che il tipo di apparecchiatura radio [\*] è conforme alla direttiva 2014/53/UE.

Il testo completo della dichiarazione di conformità UE è disponibile al seguente indirizzo Internet:

<https://www.pioneer-car.eu/eur/compliance>

Español:

Por la presente, Pioneer declara que el tipo de equipo radioeléctrico [\*] es conforme con la Directiva 2014/53/UE.

El texto completo de la declaración UE de conformidad está disponible en la dirección Internet siguiente:

<https://www.pioneer-car.eu/eur/compliance>

Português:

O(a) abaixo assinado(a) Pioneer declara que o presente tipo de equipamento de rádio [\*] está em conformidade com a Diretiva 2014/53/UE.

O texto integral da declaração de conformidade está disponível no seguinte endereço de Internet:

<https://www.pioneer-car.eu/eur/compliance>

Čeština:

Tímto Pioneer prohlašuje, že typ rádiového zařízení [\*] je v souladu se směrnicí 2014/53/EU.

Úplné znění EU prohlášení o shodě je k dispozici na této internetové adrese:

<https://www.pioneer-car.eu/eur/compliance>

Eesti:

Käesolevaga deklareerib Pioneer, et käesolev raadioseadme tüüp [\*] vastab direktiivi 2014/53/EL nõuetele.

El'i vastavusdeklaratsiooni täielik tekst on kättesaadav järgmisel internetiaadressil:

<https://www.pioneer-car.eu/eur/compliance>

**Magyar:**

Pioneer igazolja, hogy a [\*] típusú rádióberendezés megfelel a 2014/53/EU irányelvnek.  
Az EU-megfelelőségi nyilatkozat teljes szövege elérhető a következő internetes címen:  
<https://www.pioneer-car.eu/eur/compliance>

**Latviešu valoda:**

Ar šo Pioneer deklarē, ka radioiekārta [\*] atbilst Direktīvai 2014/53/ES.  
Pilns ES atbilstības deklarācijas teksts ir pieejams šādā interneta vietnē:  
<https://www.pioneer-car.eu/eur/compliance>

**Lietuvių kalba:**

Aš, Pioneer, patvirtinu, kad radijo įrenginių tipas [\*] atitinka Direktyvą 2014/53/ES.  
Visas ES atitikties deklaracijos tekstas prieinamas šiuo interneto adresu:  
<https://www.pioneer-car.eu/eur/compliance>

**Malti:**

B'dan, Pioneer, niddikjara li dan it-tip ta' taghmir tar-radju [\*] huwa konformi mad-Direttiva 2014/53/UE.  
It-test kollu tad-dikjarazzjoni ta' konformita' tal-UE huwa disponibbli f'dan l-indirizz tal-Internet li ġej:  
<https://www.pioneer-car.eu/eur/compliance>

**Slovenčina**

Pioneer týmto vyhlasuje, že rádiové zariadenie typu [\*] je v súlade so smernicou 2014/53/EÚ.  
Úplné EÚ vyhlásenie o zhode je k dispozícii na tejto internetovej adrese:  
<https://www.pioneer-car.eu/eur/compliance>

**Slovenščina:**

Pioneer potrjuje, da je tip radijske opreme [\*] skladen z Direktivo 2014/53/EU.  
Celotno besedilo izjave EU o skladnosti je na voljo na naslednjem spletnem naslovu:  
<https://www.pioneer-car.eu/eur/compliance>

**Română:**

Prin prezenta, Pioneer declară că tipul de echipamente radio [\*] este în conformitate cu Directiva 2014/53/UE.  
Textul integral al declarației UE de conformitate este disponibil la următoarea adresă internet:  
<https://www.pioneer-car.eu/eur/compliance>

**Български:**

С настоящото Pioneer декларира, че този тип радиосъоръжение [\*] е в съответствие с Директива 2014/53/ЕС.  
Цялостният текст на ЕС декларацията за съответствие може да се намери на следния интернет адрес:  
<https://www.pioneer-car.eu/eur/compliance>

**Polski:**

Pioneer niniejszym oświadcza, że typ urządzenia radiowego [\*] jest zgodny z dyrektywą 2014/53/UE.  
Pełny tekst deklaracji zgodności UE jest dostępny pod następującym adresem internetowym:  
<https://www.pioneer-car.eu/eur/compliance>

**Norsk:**

Herved Pioneer erklærer at radioutstyr type [\*] er i samsvar med direktiv 2014/53 / EU.  
Den fullstendige teksten i EU-samsvarserklæringen er tilgjengelig på følgende internettadresse :  
<https://www.pioneer-car.eu/eur/compliance>

**Íslenska:**

Hér með Pioneer lýsir yfir að tegund ráðflausan búnað [\*] er í samræmi við tilskipun 2014/53/ESB.  
The fullur texti af ESB-samræmisýfirlýsingu er í boði á eftirfarandi veffangi:  
<https://www.pioneer-car.eu/eur/compliance>

**Hrvatski:**

Pioneer ovime izjavljuje da je radijska oprema tipa [\*] u skladu s Direktivom 2014/53/EU.  
Cjeloviti tekst EU izjave o skladnosti dostupan je na sljedećoj internetskoj adresi:  
<https://www.pioneer-car.eu/eur/compliance>

**Türk:**

Burada. Pioneer radyo ekipmanı turunun [\*] 2014/53/EU direktiflerine uyumlu olduğunu beyan eder.  
Avrupa uyumluluk beyanının tam metni belirlenen internet sitesinde mevcuttur :  
<https://www.pioneer-car.eu/eur/compliance>

# Precaution

Certain country and state laws may prohibit or restrict the placement and use of this product in your vehicle. Please comply with all applicable laws and regulations regarding the use, installation and operation of this product. It is the user's responsibility in compliance with all applicable laws and ordinance.

## Information for users on collection and disposal of old equipment and used batteries

(Symbol for equipment)



(Symbol examples for batteries)



These symbols on the products, packaging, and/or

**accompanying documents mean that used electrical and electronic products and batteries should not be mixed with general household waste.**

**For proper treatment, recovery and recycling of old products and used batteries, please take them to applicable collection points in accordance with your national legislation.**

By disposing of these products and batteries correctly, you will help to save valuable resources and prevent any potential negative effects on human health and the environment which could otherwise arise from inappropriate waste handling.

For more information about collection and recycling of old products and batteries, please contact your local municipality, your waste disposal service or the point of sale where you purchased the items

**These symbols are only valid in the European Union.**

**For countries outside the European Union:**

If you wish to discard these items, please contact your local authorities or dealer and ask for the correct method of disposal.

## ⚠ CAUTION

- The graphical symbol  placed on the product means direct current.

## Safety Precautions

Always observe the precautions described here to prevent harm to yourself and others and to prevent damage to property before it happens.

### Internal Rechargeable Lithium-ion Battery

**This device uses an internal rechargeable lithium ion battery that should last the lifetime of the device. If you suspect your battery may be dead, try charging it several times. If the battery does not recharge, please consult Pioneer support.**

## Important safeguards

### ⚠ WARNING

- Do not install this product in your vehicle if its location or use would obstruct the driver's clear view of the road or the operation of any vehicle airbag. It is also the driver's responsibility to know and comply with the laws, rules, and regulations of the driving location, including, for example, passenger privacy rights, and not to use the device in any location where its installation or use is prohibited.
- The laws in your location may require you to provide notice to passengers that a recording device is in use. If so, you should place the notice sticker in a location clearly visible to your passengers.
- Any obstruction of or other interference with the airbag, either deployed or non-deployed, or with the clear view of the road must be avoided and, accordingly, professional installation is required.

- We recommend that this product be set up and installed by a technician who has special training and experience in mobile electronics.

## Important safety information

### WARNING

- Do not allow this product to come into contact with liquids. Electrical shock could result. Also, damage to the product, smoke, and overheating could result from contact with liquids.
- If liquid or foreign matter should get inside this product, park your vehicle in a safe place, turn the ignition switch off (ACC OFF) and consult your dealer or the nearest authorised Pioneer Service Station. Do not use this product in this condition because doing so may result in a fire, electric shock, or other failure.
- If you notice smoke, a strange noise or odour from this product, or any other abnormal signs on the LCD screen, turn off the power immediately and consult your dealer or the nearest authorised Pioneer Service Station. Using this product in this condition may result in permanent damage to the system.
- Do not disassemble or modify this product, as there are high-voltage components inside which may cause an electric shock. Be sure to consult your dealer or the nearest authorised Pioneer Service Station for internal inspection, adjustments or repairs.

Before using this product, be sure to read and fully understand the following safety information:

- Do not operate this product if doing so will divert your attention in any way from the safe operation of your vehicle. Always observe safe driving rules and follow all existing traffic regulations. If you experience difficulty in operating this product or reading the display, park your vehicle in a safe location and apply the handbrake before making the necessary adjustments.
- Never set the volume of this product so high that you cannot hear outside traffic and emergency vehicles.
- Keep this manual handy as a reference for operating procedures and safety information.
- Certain functions (such as viewing of screen and certain button operations) offered by this product could be dangerous (possibly resulting in serious injury or death) and/or unlawful if used while driving. Screen display is disabled for this product while the vehicle is moving.

## To ensure safe driving

### WARNING

- In some countries the viewing of video image on a display inside a vehicle even by persons other than the driver may be illegal. Where such regulations apply, they must be obeyed.

## Precautions before connecting the system

### CAUTION

- Firmly install this product so it does not fall off the windscreen. If this product is not firmly installed, it may fall off the windscreen while driving and cause an accident. Periodically inspect this product.
- Secure all wiring with cable clamps or electrical tape. Do not allow any bare wiring to remain exposed.
- It is extremely dangerous to allow cables to become wound around the steering column or gearstick. Be sure to install this product, its cables, and wiring away in such so that they will not obstruct or hinder driving.
- Make sure that the cables and wires will not interfere with or become caught in any of the vehicle's moving parts, especially the steering wheel, gearstick, handbrake, sliding seat tracks, doors, or any of the vehicle's controls.
- Do not route wires where they will be exposed to high temperatures. If the insulation heats up, wires may become damaged, resulting in a short circuit or malfunction and permanent damage to the product.
- Do not shorten any cables. If you do, the protection circuit (fuse holder, fuse resistor or filter, etc.) may fail to work properly.

- Never feed power to other electronic products by cutting the insulation of the power supply cable of this product and tapping into the cable. The current capacity of the cable will be exceeded, causing overheating.

## To prevent damage

### **WARNING**

- When replacing the fuse, be sure to only use a fuse of the rating prescribed on this product.

## Precautions before installation

### **CAUTION**

- Never install this product in places where, or in a manner that:
  - Could injure the driver or passengers if the vehicle stops suddenly.
  - May interfere with the driver's operation of the vehicle, such as on the floor in front of the driver's seat, or close to the steering wheel or gearstick.
- To ensure proper installation, be sure to use the supplied parts in the manner specified. If any parts are not supplied with this product, use compatible parts in the manner specified after you have the parts' compatibility checked by your dealer. If parts other than supplied or compatible ones are used, they may damage internal parts of this product or they may work loose and the product may become detached.
- Do not install this product where it may
  - (i) obstruct the driver's vision,
  - (ii) impair the performance of any of the vehicle's operating systems or safety features, including airbags, hazard lamp buttons or
  - (iii) impair the driver's ability to safely operate the vehicle.
- Never install this product in front of or next to the place in the dashboard, door, or pillar from which one of your vehicle's airbags would deploy. Please refer to your vehicle's owner's manual for reference to the deployment area of the frontal airbags.
- Consult with your nearest dealer if installation requires drilling holes or other modifications of the vehicle.
- Before making a final installation of this product, temporarily connect the wiring to confirm that the connections are correct and the system works properly.
- Do not install this product in places subject to high temperatures or humidity, such as:
  - Places close to a heater, vent or air conditioner.
  - Places that may be exposed to rain, such as close to the door or on the vehicle's floor.

# Disclaimer

- Given the large number of variables and conditions that can be involved in an accident, Pioneer cannot guarantee that every accident or occurrence will trigger the recording feature in this device.
- This product features may not operate properly due to the effects of settings, how this product is installed, the condition of the microSD card, and driving conditions (including the road conditions).
- If brightly coloured objects are placed on the dashboard, they may be reflected in the front windscreen and the camera image. Do not place brightly coloured objects on the dashboard.
- This product is not guaranteed to be effective as evidence in an accident.
- This product is not guaranteed to save video in all situations.
- You may not be able to recognise the conditions in the front of the vehicle in recorded video, depending on the ambient conditions, such as the weather and time.
- LED traffic signals or street lamps on the road may appear as flashing or flickering when recorded with this product. The colour may also not be correctly identifiable. Pioneer Corporation accepts no responsibility whatsoever for these phenomena.
- This product saves video before and after an accident occurs by detecting the impact (acceleration) with the G-sensor (accelerometer). However, this product is not guaranteed to save video in all situations.
- Pioneer Corporation accepts no responsibility whatsoever for product failures or damage that occur due to the microSD card wearing out.
- Pioneer Corporation does not make any assurances that microSD card problems will be repaired by formatting the card. Pioneer Corporation bears no responsibility for files that are erased from the microSD card or damage that occurs from formatting the card. Format the microSD card according to your own judgement and at your own responsibility.



# How to read this Manual

Notation	Meaning
	These symbols are used to draw your attention to items you should be aware of when using this product and items you should be aware of to maintain its performance.
<b>Note /Notes</b>	Notes provide useful tips and extra information about product features.
[ ○ ○ ]	Square brackets are used to indicate selectable items displayed on the screen.
→ “○○○○”	Quotation marks are used to indicate references and settings.

- The illustrations and example screens used in this manual may differ from the actual product.
- The actual screens of the product may be changed without prior notification for the purpose of improvements to product performance and features.
- In this manual, the microSDHC/SDXC memory card is referred to as "the microSD card" for convenience.

# Usage Precautions

## **⚠ Precautions When Handling this product**

- The driver may manually set the device to save video to assist in the monitoring of driver performance.
- There are limits to the scope of video that can be recorded with this product (→ **“Specifications”**). First check the video that will be recorded before using this product.
- Do not use this product in locations subjected to high temperatures of 60°C or higher, low temperatures of -10°C or lower, or high humidity.
- Be careful not to infringe on the privacy of any subject in video recorded with this product when using said video. You are fully responsible for the use of said video. Video recorded with this product may include personal information, such as numbers on number plates.
- Recording time may shorten or recording may not be possible when the power supply to the product stops (vehicle engine is turned off) with the battery insufficiently charged immediately after purchase.
- Be sure to use the included power cable for charging the battery.
- Pioneer Corporation does not offer a data recovery service for corrupted or deleted files.
- The storage areas on the microSD card are split into the four areas shown in the following diagram according to the type of recording.

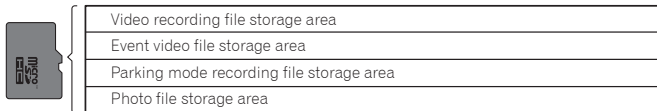

- Note that files will be overwritten when there is insufficient free space in the file storage areas. We recommend that you back up any important files you want to keep.→ **“Backing Up Recorded Files”**
- To ensure that important files, such as files containing records of accidents, are not overwritten, always turn the power off before removing the microSD card and store the card in a safe place. → **“Inserting and Ejecting the microSD Card”**
- You can view video files on your PC. However, the video may stutter or stop depending on the performance of the PC.
- If this product is used near another device that uses GPS, such as a car navigation system, that device may temporarily be unable to receive radio waves from GPS satellites due to radio interference. There may also be a negative impact on the functions of surrounding devices.
- The internal battery is a consumable part. The operating time will slowly decrease as the battery is repeatedly charged. Contact Pioneer support if you feel that the operating time has become too short.
- Do not touch the lens with your hands. Wipe the lens off with a soft cloth if you touch it.

## **⚠ Precautions When Handling the microSD Card**

- Keep the microSD card out of the reach of small children to prevent them from accidentally swallowing it.
- To prevent data loss and damage to the microSD card, never remove it from this product while data is being transferred.
- If data loss or corruption occurs on the microSD card for any reason, it is usually not possible to recover the data. Pioneer accepts no liability for damages, costs or expenses arising from data loss or corruption.
- Never insert or eject a microSD card while driving.
- This product supports microSDHC/SDXC cards (8 GB to 128 GB, Class 10). Not all microSD cards are guaranteed to work with this product.

- Format the microSD card before using it. Do not use a microSD card that contains other data, such as that from a PC.
- Periodically format the microSD card.
- Do not eject the microSD card when it is being accessed. The file or card may be corrupted.
- Even if the microSD card is used normally, you may no longer be able to write data to the card or erase data from the card normally.
- The service life of the microSD card is not covered under the warranty.
- The microSD card is a consumable part. We recommend that you regularly replace the microSD card with a new card. If you use the microSD card for a long period of time, this product may no longer be able to save data to the card correctly due to bad sectors, or an error may occur and the card will no longer be usable.
- On rare occasions, a microSD card that is recognised by your computer may not be recognised by this product. In this case, depending on the problem with the microSD card, this product may be able to recognise the card by formatting it with this product format feature → ***“This product Settings” - “Configurable Features” - “System” - “Format SD Card”***. However, all files, including protected files, saved to the microSD card will be erased when it is formatted. Always back up the files on the microSD card before formatting it.
- Pioneer Corporation does not make any assurances that microSD card problems will be repaired by formatting the card. Pioneer Corporation bears no responsibility for files that are erased from the microSD card or damage that occurs from formatting the card. Format the microSD card according to your own judgement and at your own responsibility.

# Check the Accessories

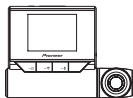

Main Unit×1



2nd Camera×1



Mounting Bracket×1



Power Cable  
(5 m)×1  
Mini Pin Jack-RCA  
Conversion Cable  
(0.2 m)×1



AV Cable  
(5 m)×1



2nd Camera  
Connection Cable  
(3 m)×1\*



2nd Camera  
Connection Cable  
(6 m)×1\*



microSDHC Card  
(16 GB)×1



Quick Start Guide×1



Warranty×1



Cleaning Cloth×1

\* The 2nd camera connection cable is included already connected.

# Before Installing the Product

## **⚠ WARNING**

- When installing the product on vehicles installed with an air bag, never install on the cover of the air bag and at locations that might obstruct the deployment of the air bag. Doing so might prevent the air bag from being deployed normally, cause the product to fly out due to air bag deployment, and cause accident and injury.

## **⚠ CAUTION**

- First check with the vehicle manufacturer for precautions related to the installation work when installing the product in a vehicle equipped with airbags. Otherwise there is a risk of airbag malfunction.
- Always use the included parts as specified. There is a risk of product failure if other parts are used.
- Install this product in a location where it will not hinder vehicle equipment and the ability to drive the vehicle.

## Installation Precautions

- Main unit and 2nd camera are for installation to the inside of the front and rear windows only. Do not install it anywhere else inside or outside of the vehicle.
- When installing main unit to the inside of the front windscreen and within the specified dimensions.
- When installing the 2nd camera to the inside of the rear window, pay attention to the following points.
  - Avoid installing the 2nd camera on heating wires on windscreens.
  - If the vehicle is provided with a rear wiper, install so that it is within the wiping range of the wiper.
  - Install the 2nd camera as far as possible from the high mount stop lamp.
- Depending on the vehicle, installation at the specified location and within the specified dimensions may not be possible. For details, consult with your dealer.
- Do not cover this product and 2nd camera or get the lens dirty.
- Do not place reflective objects near the lens.
- Take care when handling this product and 2nd camera so that they do not drop and you do not touch the lens.
- Recording quality may be affected if the front windscreen of the vehicle is coated or has been specially treated.
- This product may not be able to receive GPS signals if the front windscreen of the vehicle has been specially treated. Check the GPS reception status indicator displayed on the screen of this product. If a GPS signal cannot be received, this product cannot be installed in this vehicle. → **"Using this product" - "Status Display"**
- Choose a working location free from dust and debris in the air.
- When the temperature is low or there is condensation on the glass, turn on the heater and defroster to warm up the window in order to prevent poor adhesion of the double-sided tape.

Double-sided tape cannot be re-applied once it is peeled off as peeling off weakens its adhesive strength. Be sure to temporarily fasten this product and 2nd camera and sufficiently consider routing of cables before applying double-sided tape.

## Installation Tips

### Before Installing and Securing the Product

- First, temporarily connect this product and confirm that it operates correctly, and then install it. If the product does not operate correctly, check again if there is a mistake in the connection.

### Before Applying Double-sided Tape

- Clean the location where the double-sided tape will be applied.

# Installation

## Specified Installation Position on Front Windscreen

When installing this product the inside of the front windscreen, install in a vehicle and in a position that satisfies all of the following conditions.

- A position where this entire product is within 20% of the top edge of the height of the front windscreen (range within 20% of the actual length, excluding parts overlapping weatherstrips, mouldings, etc. and masked parts) or are in the shadow of the rear view mirror as viewed from the driver's seat. Note that "20%" as described above is a rough estimate. Please install the product in accordance with your country's laws and regulations.
- A position where the lens part of this product is within the wiping range of the wiper.
- A position where the lens part of this product does not hang over the sunshade and black ceramic lines/black ceramic pattern.
- A position where this product faces in the horizontal direction to the front and side to side.
- A position where the power cable can be routed without unnecessary force.

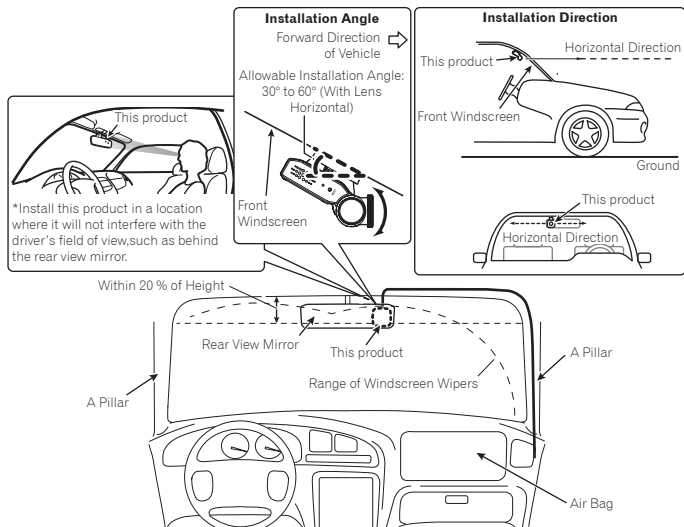

### ⚠ IMPORTANT

Always install this product in the specified installation position to ensure a safe field of view while driving and to achieve full performance from the product.

## Recommended Installation Position on Rear Windscreen

When installing the 2nd camera on the inside of the rear window, installation in a vehicle and in a position that satisfies all of the following conditions is recommended.

- A position where the lens part of the 2nd camera is within the wiping range of the wiper.
- A position where the 2nd camera faces in the horizontal direction to the rear and side to side.
- A position where the lens part of the 2nd camera and the double-sided tape do not overlap the heating wires.
- A position where the 2nd camera connection cable can be routed without unnecessary force.

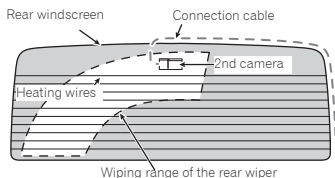

### 1 Clean the installation area of dirt and oils using the included cleaning cloth.

#### Front windscreen

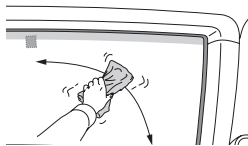

#### Rear windscreen

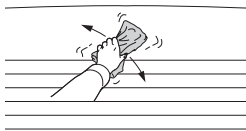

### 2 Install this product.

- ① : Set the mounting bracket on this product.
- ② : Peel off the double-sided tape release paper from the mounting bracket.
- ③ : Install at the specified position of the front windscreen.

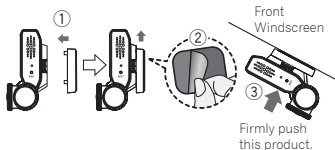

### ⚠ CAUTION

- Make sure that the surface of the front windscreen is dry before applying the tape.
- Firmly push the area around the LCD. Next, remove this product from the mounting bracket, directly press the mounting bracket against the tape. In this way, the product can be firmly installed on the windscreen.
- Never touch the surface of the LCD.



- Use extreme care as the double-sided tape on the mounting bracket is extremely strong, and it will be difficult to reapply the tape once it has been applied.
- To ensure the installation strength of the adhesive tape, leave this product for 24 hours after application before using it.

### 3 Install the 2nd camera.

- ① : Peel off the double-sided tape release paper from the 2nd camera.
- ② : With the flat part shown in the figure facing up (position where the  $\triangle$  mark on the side is facing up), install the 2nd camera at the specified position on the rear windscreen.

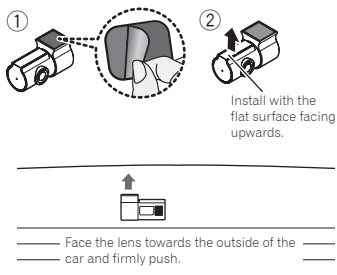

### 4 Connect the power cable, 2nd camera connection cable and AV cable to this product.

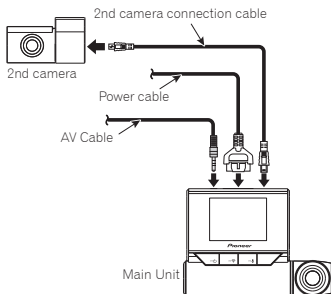

#### Notes

- Connecting the AV cable is only required if connecting the VREC-DZ700DC to a compatible stereo with an AV Input.

**5 Route the power cable, 2nd camera connection cable and AV cable to the passenger seat side.**

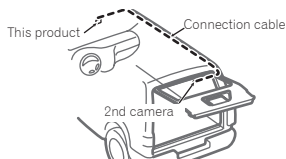
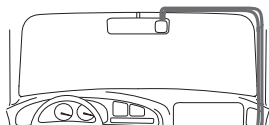

**6 Connect the power cable and AV cable.**

→ *“Connecting the Power Cable”*

**7 Turn the vehicle engine on to display the recording screen.**

**8 Adjust the angle of the lens so that video outside and inside the vehicle is properly displayed.**

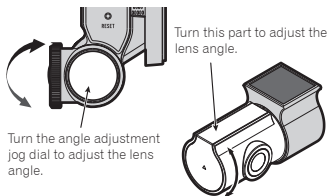

During driving, turn the lens of this product towards the outside of the vehicle.

This product restarts when the lens angle is moved from the outside of the vehicle to the inside, and vice versa.

To switch between camera video from this product and video from the 2nd camera, press the  button. → *“Function Buttons”*

**Note**

A protective film is applied to the lens when the product is purchased. Peel off this film.

# Connecting the Power Cable

Be sure to disconnect the  $\ominus$  terminal of the vehicle's battery before connecting the power cable.

The parking mode (security mode allowing 24-hour, 365-day surveillance) can be used by extracting power directly from the vehicle by the power cable.

You can also connect the product to a compatible stereo by the AV cable or mini pin jack-RCA conversion cable to project realtime video from this product or movies and photos that are being played back on the screen of the navigation.

English

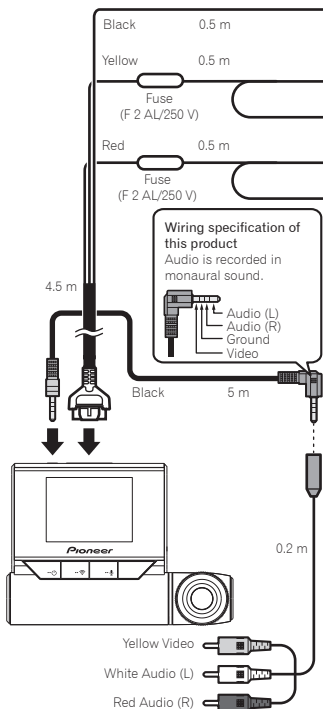

### Ground (Black)

Securely connect to the metal part of the vehicle body. To prevent noise, connect as close to the navigation unit as possible.

### + Battery power supply (Yellow)

Always connect to the power circuit supplied with power from the battery, regardless of whether the vehicle engine switch is ON or OFF.

### Accessory power supply (Red)

Connect to the power circuit supplied with power when the vehicle engine switch is turned to the ACC position. Never install the accessory power supply to a vehicle that does not have an ACC position on the engine switch. Doing so may lead to a dead battery.

**Note:** Connect the red and yellow lead wires to the terminals after wiring through the vehicle's fuse unit.

### Video/audio output mini pin jack

Connect to the AUX input of the main unit of a Pioneer product with a mini jack terminal compatible with video input.

Connection to main units of other brands with RCA input terminals is also possible by using the included mini pin jack-RCA conversion cable (figure below).

\*After connecting, the following message is displayed: "Is the 3.5mm Audio/Video Jack Connected?" Select "Yes" or "No".

### ⚠ Connection Precautions

To prevent fuming and damage to the product, be sure to first securely connect the black lead wire (Ground) of this product to the metal part of the vehicle body.

Connect separate black lead wires (Ground) for products with a high current consumption such as a power amplifier. When setting up connections all at once, there is a risk of fuming or damage to the product when screws loosen or come off completely.

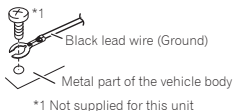

# Part Names

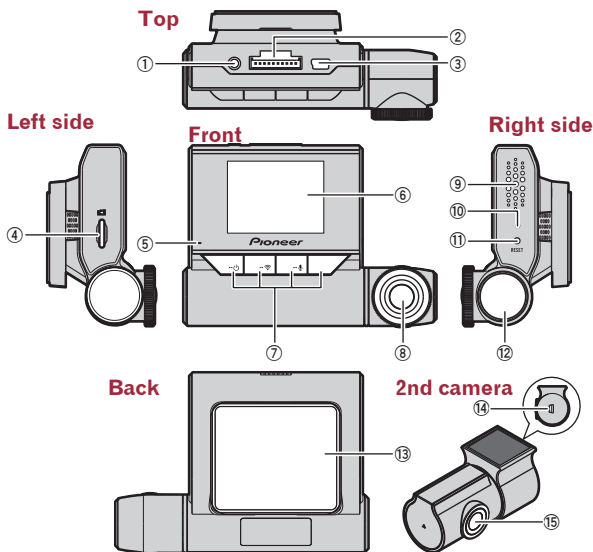

## ① AV Output Terminal

## ② Power Port

Connect the power cable and AV cable.

## ③ 2nd Camera Connection Terminal

Connect to the 2nd camera connection terminal (14) using the 2nd camera connection cable.

## ④ microSD Card Slot

## ⑤ System Indicator

## ⑥ LCD

## ⑦ Function Buttons

## ⑧ Lens

Pioneer polarised filter AD-PLF100 (sold separately) can help reduce reflections of the dashboard onto the windscreen, and enable the capture of high-contrast videos.

## ⑨ Speaker

## ⑩ Microphone

## ⑪ Reset Button

Press this button with the tip of a ballpoint pen to reset this product.

## ⑫ Angle Adjustment Jog Dial

The angle of the lens can be adjusted by turning this dial.

## ⑬ Mounting Bracket

## ⑭ Connection Terminal

## ⑮ Lens

# Inserting and Ejecting the microSD Card

Turn off the power to this product when inserting and removing the microSD card. → **“Manually Turning the Power On and Off”**

## Inserting the microSD Card

Hold the top edge of the microSD card, position the microSD card so that the label is facing the backside of this product, and slowly insert it into the microSD card slot until it clicks.

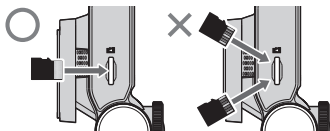

### **⚠ CAUTION**

Do not insert the microSD card at an angle. Doing so may cause damage.

## Ejecting the microSD Card

Slowly push in the top edge of the microSD card until it clicks (①). The lock will be released. Pull out the microSD card (②).

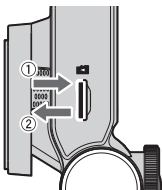

# Backing Up Recorded Files

When the free space of the file storage areas is low, files are deleted from the oldest file.

We recommend that you back up any important files you want to keep with the following procedure.

## Note

Prepare a spare microSD card in advance.

### 1 Replace the microSD card.

Stop the vehicle in a safe location. Then turn off this product power, eject the microSD card, and replace it with a spare microSD card.

### 2 Copy or move the files to a PC.

Insert the microSD card into a PC, using a commercially available SD card adapter if necessary. Copy or move the videos and photo files to back up to a suitable location on the PC.

## Folder and File Structure

The structure of folders and files in a microSD card is as follows.

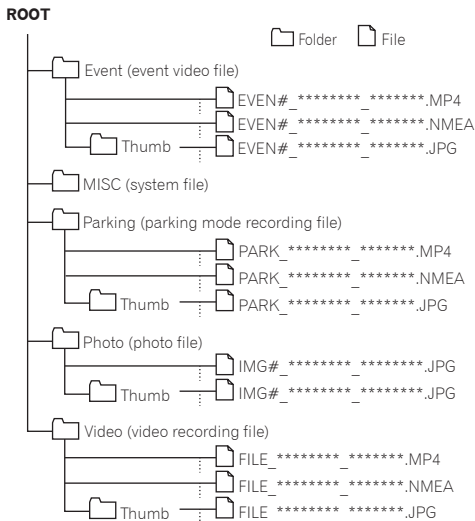

## Notes

- A symbol that indicates this product camera "M" or 2nd camera "E" is automatically assigned at "#".
- The year, month, day, hours, minutes, and seconds are automatically assigned at "\*\*\*\*\*\_\*\*\*\*\*".

# Using this product

Before using this product, first stop the vehicle in a safe location and apply the handbrake.





## This product Power

This product starts when the vehicle's engine is turned on (ACC ON), and it automatically starts recording. (Video recording) → **"Using this product" - "Video Recording"**

If the camera of this product is facing the inside of the vehicle when the vehicle engine is turned on (ACC ON), a message is output and the alarm sounds.

## Manually Turning the Power On and Off

This product can be manually turned on and off.

Hold down the  function button in the recording screen for at least three seconds. The power off confirmation screen is displayed. Press the  /  function button to select [Yes], and press  to turn the power off. Hold down the  function button again for at least three seconds, and the power is turned on.

## Guide to Charging Time

It takes approximately three hours to charge a flat battery.

### Note

In high temperatures, the internal battery will stop charging for safety.

## System Indicator Display

The operating status of this product is displayed with the system indicator.

System Indicator	Menu Displayed/ During Playback	Video Recording	Recording Event	Error Has Occurred (Including microSD Card not Inserted)
Illuminated green	—	○	—	—
Illuminated red	—	—	○	—
Blinking red	—	—	—	○

## Function Buttons

The functions of the function buttons are indicated by the icons displayed at the bottom of the screen.

The functions of the buttons will depend on the displayed screen. (Icons are not displayed on some screens.)

In the playback screen or MENU screen, pressing the  function button returns you to the previous screen.



## Recording

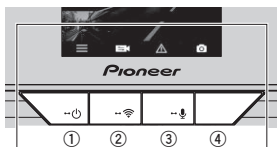

- 1 Main menu display
- 2 Switching of camera video  
Hold down to switch Wi-Fi on/off
- 3 Manual recording of events  
Hold down to switch microphone on/off
- 4 Take photo

## During playback

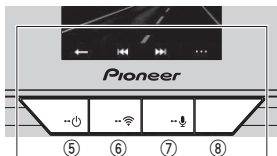

- 5 Back
- 6 Next file
- 7 Previous file
- 8 Play/stop, delete

## During MENU screen display

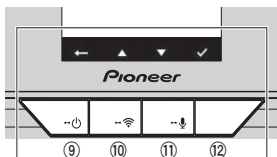

- 9 Back
- 10 Up\*  
Hold down to switch Wi-Fi on/off
- 11 Down\*  
Hold down to switch microphone on/off
- 12 Confirm

\* When the volume or sensitivity MENU screen is displayed, increase or decrease the volume or sensitivity.

## Status Display

The status display shows the operating status of this product.



- 1 Recording in progress
- 2 Elapsed recording time
- 3 Event recording status\*1
- 4 Parking mode
- 5 Sound recording\*2
- 6 Wi-Fi connection status\*3
- 7 GPS reception status\*4
- 8 Power status  
( : Battery mode : Charging)

- \*1 When manual event recording is performed or vibration is detected in the event recording mode, and event recording has been activated, "x2" is displayed.
- \*2 A red "\ " is displayed when sound recording is set to off.
- \*3 During a Wi-Fi connection, this is displayed in green, and when Wi-Fi is disconnected, this is displayed in white. A red "x" is displayed when Wi-Fi connection is set to off.
- \*4 During GPS reception, this is displayed in green, and when GPS cannot be received, this is displayed in white. In the parking mode, a red "x" is displayed since GPS reception is set to off.

## Video Recording

Recording automatically starts when this product is started. The recorded video is saved to the microSD card as one file of the set increment of time (default: 3 minutes), and when the microSD card runs out of free space, the files are overwritten starting from the oldest file.

### Notes

- You can change the video recording time.  
→ **"This product Settings" - "Configurable Features" - "Video Recording" - "Video Clip Length"**
- Video recording will stop under the following circumstances.
  - When the MENU screen is displayed
  - When the power supply is stopped
  - When parking mode has started
- The recording time may differ depending on the conditions.

## Event Recording

### Automatic Recording by Detecting Impacts (Event Recording)

The continuous video file when an impact was detected by this product, such as an impact with another vehicle, is automatically saved for the 20 seconds before and 20 seconds after the moment of detection as an event video file.



- \* The video recording file is saved to the "Video" folder.
- \* The event video file is saved to the "Event" folder.

### Manual Recording (Manual Event Recording)

The manual recording file when the  function button is pressed during video recording is saved for the 20 seconds before and 20 seconds after the moment the button is pressed as an event video file.

## Notes

- You can adjust the sensitivity for detecting impacts.  
→ ***"This product Settings" - "Configurable Features" - "Video Recording" - "G-Sensor Sensitivity"***
- When impact was detected or manual recording was performed in the event recording mode, event recording is started again after event recording ends.
- Video that was recorded for 20 seconds before and 20 seconds after this product detected an impact is saved to the "Event" folder.
- The recording time may differ depending on the conditions.

## Parking Mode

When the power supply to this product is turned off (vehicle engine is turned off), the parking mode is activated for a fixed period of time. The maximum operation time is approximately 40 minutes.

When this device detects vehicle movement caused by vibration while the parking mode is activated, that event is saved for 20 seconds before and 20 seconds after the moment of detection as a parking mode file, and a notification message is displayed at the next startup.

## Notes

- The parking mode can be set to on or off. The operation time of the parking mode can also be set.  
→ ***"This product Settings" - "Configurable Features" - "Parking mode" - "Parking Mode Video clip Length"***
- You can adjust the sensitivity for detecting vibration.  
→ ***"This product Settings" - "Configurable Features" - "Parking mode" - "G-Sensor Sensitivity"***
- Vibration that is detected for approximately three minutes after power supply to this device is stopped and for approximately three minutes before power supply is started is not covered by the notification message display feature.
- The recording time may differ depending on the conditions.

## Security Mode

If the pre-set operation time elapses when the security mode is turned ON, the security mode in which parking surveillance is performed 24 hours per day, 365 days per year is automatically activated.

When this device detects vehicle movement caused by vibration while the security mode is activated, that event is saved for the set normal video time after the moment of detection as a parking mode file, and a notification message is displayed at the next startup.

## Notes

- The security mode can be set to on or off.  
→ ***"This product Settings" - "Configurable Features" - "Parking mode" - "Security mode"***
- In the security mode, this product runs in the low power consumption mode to reduce the risk of the battery running flat.
- When the battery voltage drops below 11.2 V, security mode standby and recording are stopped.
- The security mode starts recording within three seconds of detection of impact.
- Vibration that is detected for approximately three minutes before the vehicle's engine is turned on (ACC ON) is not covered by the notification message display feature.
- The security mode is a feature for starting up and activating this product after an impact is detected. For this reason, the battery might wear more quickly if this product is used in mechanical multi-story parking garages or location subjected to lots of vibration. When parking in locations such as these, set the security mode to off before using this product.
- The recording time may differ depending on the conditions.

## Photography Feature

Photos can be taken during video recording or event recording by pressing the  function button.

## Playing Recorded Files

You can play recorded video files and view photo files.

### 1 Press the function button to open the main menu.

In each of the screens displayed from here on, the screen automatically returns to the recording screen if you do not perform any operation for approximately 30 seconds.

### 2 Press the / function buttons to select [File], and press .

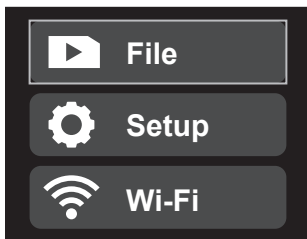

### 3 Press the / function buttons, select the folder, and then press .

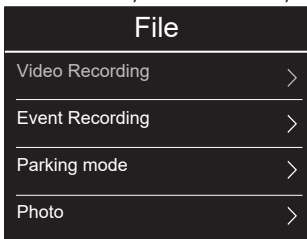

The thumbnails of files in the selected folder will be displayed.

4 Press the  /  function buttons, select the file, and then press .

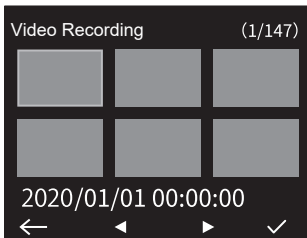

The selected file will play.

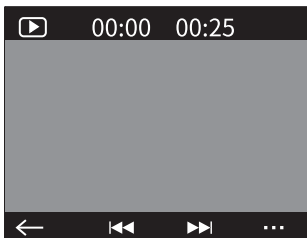

#### Note

In the screens in Steps 2 to 4 (excluding the playback screen), pressing the  function button returns you to the previous screen.

# This Product Settings

Before using this product, first stop the vehicle in a safe location and apply the handbrake.

These settings configure this product. You can reset the settings to the default settings.

You can also format the microSD card and check this product version information.

Note that video recording will stop while the MENU screen is displayed.

## 1 Press the function button to open the main menu.

In each of the screens displayed from here on, the screen automatically returns to the recording screen if you do not perform any operation for approximately 30 seconds.

## 2 Press the / function buttons, then select [Setup] or [Wi-Fi], and press .

The following describes an example for when [Setup] has been selected.

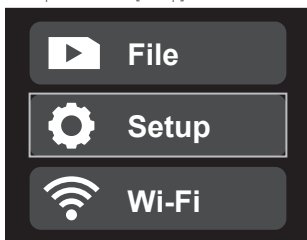

## 3 Press the / function buttons, select the setting category, and then press .

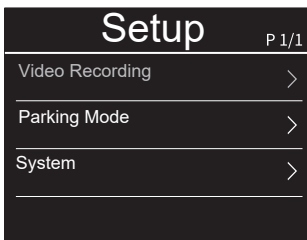

4 Press the  /  function buttons, select the setting item, and then press .

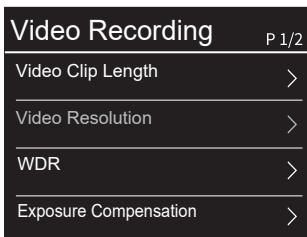

5 Press the  /  function buttons, select the setting value, and then press .

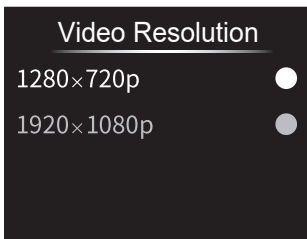

▼

This completes setting, and you are returned to the previous screen.

**Note**

In the screens in Steps 2 to 4, pressing the  function button returns you to the previous screen.

## Configurable Features

### Values

Setting Category	Setting	Details	Default Settings
<b>Video Recording</b>	Video Clip Length	Sets the recording time for one video recording video file in video recording.	3 min
	Video Resolution	Sets the image quality of video recording.	1920×1080p
	WDR (Wide Dynamic Range)	Sets use of the feature that automatically adjusts the image in situations where there is a large difference between light and dark.	ON
	Exposure Compensation	Sets the exposure of video recording.	0
	G-Sensor Sensitivity	Sets the sensitivity for detecting vibration or impact.	Level4
<b>Parking Mode</b>	Parking Mode Video Length	Sets the operation time of the parking mode/security mode. This can also be set to OFF.	40 min
	G-Sensor Sensitivity	Sets the sensitivity for detecting vibration or impact.	Level4
	LED Indicator	Sets whether or not to light the LED indicator when the parking mode/security mode is activated.	ON
	Security mode	Sets whether or not to use the security mode.	ON



Setting Category	Setting	Details	Default Settings
System	Link GPS Date time	Sets the time zone.	±0
	Date/Time	Sets the time manually.	—
	System Sound Volume	Sets beeps and playback volume. This can also be set to OFF.	Level3
	Mic Mute	Sets whether or not to record sound around this product during video recording.	ON
	SD Card Partition	Changes the SD card partition.	59% 10% 30% 1%
	Button Sound	Sets whether or not to sound beeps.	ON
	Monitor Display Setting*1	Sets the time that the products enter the sleep mode. When the settings menu is displayed, the product does not enter the sleep mode regardless of how this item is set.	Screen Off in 3 min.
	Video/Audio Output	Sets the video/audio output connection ON/OFF.	OFF
	Language	Sets the language used to display the screen.	English
	Format SD Card	All files on the microSD card can be deleted. *2	—
	Restore to Factory Mode	Settings can be reset to the default settings.	—
	Version	Allows you to check the version information of this product firmware.	—

\*1 When the parking mode/security mode is activated, LCD Standby turns off after ten seconds regardless of this setting.

\*2 When there is some problem with the microSD card, a warning tone sounds and an alarm message, such as "No SD card" is displayed, and recording stops.

## Wi-Fi

Setting Category	Setting	Details	Default Settings
—	—	Sets whether or not to connect a Wi-Fi tethering supported terminal to this product.	ON (connectable)

In the recording screen, Wi-Fi on/off can be switched by holding down the  function button.

# Guide to Recording Time and No. of Photos

The following table provides estimates of the video recording times and number of photos possible with different "SD Card Partition" settings. The actual values will depend on various factors, such as the microSD card being used, subject being recorded, and recording conditions.

The "SD Card Partition" setting is expressed as follows.

Example: [79% 10% 10% 1%]

As a percentage of memory card capacity, the video recording time will be 79%, the event recording time will be 10%, the parking mode time will be 10%, and the number of photos will be 1%.

## Guide to Recording Time and No. of Photos with an 16 GB microSD Card

SD Card Partition	Resolution	Video Recording	Event Recording	Parking Mode Recording	No. of Photos
[59% 10% 30% 1%]	1080p	Approx. 40 minutes	Approx. 7 minutes	Approx. 22 minutes	Approx. 400 photos
	720p	Approx. 48 minutes	Approx. 8 minutes	Approx. 25 minutes	Approx. 400 photos
[79% 10% 10% 1%]	1080p	Approx. 55 minutes	Approx. 7 minutes	Approx. 7 minutes	Approx. 400 photos
	720p	Approx. 1 hour 5 minutes	Approx. 8 minutes	Approx. 8 minutes	Approx. 400 photos

## Guide to Recording Time and No. of Photos with an 128 GB microSD Card

SD Card Partition	Resolution	Video Recording	Event Recording	Parking Mode Recording	No. of Photos
[59% 10% 30% 1%]	1080p	Approx. 5 hour 20 minutes	Approx. 1 hours	Approx. 3 hours	Approx. 400 photos
	720p	Approx. 6 hour 24 minutes	Approx. 1 hour 8 minutes	Approx. 3 hour 24 minutes	Approx. 400 photos
[79% 10% 10% 1%]	1080p	Approx. 7 hour 20 minutes	Approx. 1 hours	Approx. 1 hours	Approx. 400 photos
	720p	Approx. 8 hour 40 minutes	Approx. 1 hour 8 minutes	Approx. 1 hour 8 minutes	Approx. 400 photos

## Guide to Recording Time When Fully Charged

Parking mode operation time: Approx. 40 minutes

### Note

The recording times are estimates. The actual recording times will depend on the scenery being recorded.

# Exclusive App

The exclusive app "Dash Camera Interface" can be used to check the video recorded on this product or make settings on the screen of an iPhone or smartphone (Android™).

To use this app, a Wi-Fi connection must be made between this product and iPhone/smartphone (Android™) beforehand.

- ① Set the Wi-Fi function of this product to on. → **"This Product Settings"**
  - ② Operate the iPhone or smartphone (Android™) to select this product as the Wi-Fi connection device.  
The SSID name (access point name) and password of this product can be checked in the Wi-Fi settings screen.
- Only one iPhone/smartphone (Android™) device can be connected to this product at any one time. When a second device is connected, the first device is disconnected.
  - While a Wi-Fi connection is made, no operations can be performed on this product. If a function button is pressed while a Wi-Fi connection is made, a message will be displayed prompting you to break the Wi-Fi connection. If you select [Yes], the Wi-Fi connection will be disconnected, and operations on this product will be enabled.
  - You can change the SSID name of this product by operating the exclusive app "Dash Camera Interface". Note, however, when the SD card is formatted, the SSID name returns to its default setting.
  - It is recommended to enter the search term "Dash Camera Interface" in the search field to search for the application.



# Trademarks & Copyrights

- microSDHC Logo is a trademark of SD-3C, LLC.



- microSDXC Logo is a trademark of SD-3C, LLC.



- Android is a trademark of Google Inc.
- The Wi-Fi CERTIFIED Logo™ is a certification mark of the Wi-Fi Alliance.



- iPhone is a trademark of Apple Inc.

# GPS

- GPS (Global Positioning System) is a system that measures your current position by receiving position measurement radio signals from GPS satellites.
- The GPS satellite signals cannot pass through solid matter (except glass). The signals from GPS satellites may be blocked when this product is in the following locations.
  - Inside tunnels and parking structures
  - On the bottom level of a two-level highway
  - Around concentrations of skyscrapers
  - In dense forests

# Troubleshooting

Check the following information before sending the product in for repairs.

Symptom	Cause	Action
An error occurred during the display and operation of this product.	The microcomputer in this product is malfunctioning.	Press the reset button.
A file that should have been saved cannot be found.	If there is insufficient space in the storage areas of the microSD card, the files will be overwritten in order from the oldest files.	We recommend that you back up any important files you want to keep. → <b>"Backing Up Recorded Files"</b>
The product makes parking mode files when you get in and out of the vehicle.	The vibration when people get in and out of the vehicle and the movement of people are being detected.	Adjust the sensitivity of the sensors to use for detection. → <b>"This Product Settings" - "Configurable Features" - "Values" - "Parking mode" - "G-Sensor Sensitivity"</b>
There are many videos where nothing happens in the files recorded while parked.	The sensitivity of impact detection may not be appropriate.	
My vehicle was hit while parked, but a video file wasn't recorded.		
An accident occurred during driving, but a video file wasn't recorded.	The sensitivity of impact detection may not be appropriate.	Adjust the sensitivity of the sensors to use for detection. → <b>"This Product Settings" - "Configurable Features" - "Values" - "Video Recording" - "G-Sensor Sensitivity"</b>
There's no sound when I play a video file.	The sound recording setting may be OFF.	Check the sound recording setting again. → <b>"This Product Settings" - "Configurable Features" - "Values" - "System" - "Mic Mute"</b>

# Specifications

<b>Recording Medium</b>	microSDHC/microSDXC card, Class 10 (8 GB to 128 GB)
<b>Imaging Element</b>	Approx. 2 million pixels (on-board high-sensitivity CMOS sensor)
<b>Recording Angles</b>	Main Unit: 130° horizontal, 68° vertical, 160° diagonal 2nd camera: 112° horizontal, 58° vertical, 137° diagonal
<b>F-Number</b>	Main Unit: F2.0 2nd camera: F1.9
<b>Recording mode</b>	1920 × 1080P/1280 × 720P
<b>Image correction technology</b>	WDR function (HDR / WDR 2nd Camera)
<b>GPS</b>	Built-in
<b>Wi-Fi</b>	<ul style="list-style-type: none"><li>• On-board (for connection of iOS/Android exclusive apps) 802.11b/g/n</li><li>• Output power: + 17.5 dBm Max.</li><li>• Frequency band(s): 2412 - 2472 Mhz</li></ul>
<b>G-Sensor</b>	3-axis G-sensor (During event recording: level can be set in 6 steps/during parking mode: level can be set in 6 steps)
<b>Recording Methods</b>	Video recording/event recording/manual event recording/parking mode recording
<b>Video File Structure</b>	1 min/3 min/5 min
<b>Display</b>	2-inch LCD
<b>Sound Recording</b>	Can be set to ON or OFF
<b>Frame Rate</b>	27.5 fps
<b>Compression Method</b>	Video: MP4 (H.264), photo: JPG
<b>Video Playback Method</b>	iOS/Android exclusive apps, etc.
<b>Power Supply Voltage</b>	12 V/24 VDC (exclusive power supply and AV cable included)
<b>Internal Battery Capacity</b>	750 mAh
<b>Power Consumption</b>	Approx. 5 W (approx. 8.5 W when charging)
<b>Operating Temperature</b>	-10 °C to +60 °C
<b>Dimensions (W × H × D)</b>	Main Unit: 108.5 mm × 77.4 mm × 40.5 mm (width × height × depth) 2nd camera: 63.2 mm × 37.1 mm × 31.6 mm (width × height × depth)
<b>Weight</b>	Main Unit: 138 g (excluding bracket, etc.) 2nd camera: 35 g
<b>Allowable Installation Angle</b>	30° to 60°

**<https://www.pioneer-car.eu/eur/>**

Visit [www.pioneer-car.eu/uk/](http://www.pioneer-car.eu/uk/) (or [www.pioneer-car.eu/eur/](http://www.pioneer-car.eu/eur/)) to register your product.

**PIONEER CORPORATION**

28-8, Honkomagome 2-Chome,  
Bunkyo-ku, Tokyo 113-0021  
Japan

**PIONEER EUROPE NV**

Haven 1087, Keetberglaan 1  
9120 Melsele  
Tel: 32-3-570-0511  
Fax: 32-3-570-0886