

Pioneer

VREC-Z810SH

DASH CAMERA

 English

Owner's Manual

Contents

Thank you for buying this Pioneer product.
Please read through these instructions so you will know how to operate your model properly. After you have finished reading the instructions, keep this document in a safe place for future reference.

Precaution	6
Safety Precautions	7
Disclaimer	10
How to read this Manual	11
Usage Precautions	12
Check the Accessories	14
Before Installing the Product	15
Installation Precautions	15
Installation Tips	16
Installation	17
Specified Installation Position on Front Windscreen	17
Recommended Installation Position on Rear Windscreen	18
Connecting the Power Cable	22
Part Names	24
Inserting and Ejecting the microSD™ Card	25
Inserting the microSD Card	25
Ejecting the microSD Card	25
Backing Up Recorded Files	26
Folder and File Structure	26
Using this product	27
This product Power	27
System Indicator Display	27
Function Buttons	28
Status Display	29
Video Recording	29
Event Recording	30
Security Mode	30
Photography Feature	31
Playing Recorded Files	31
Advanced Driver Assistance Systems (ADAS)	32
Voice recognition	34
This Product Settings	35
Configurable Features	37
Guide to Recording Time and No. of Photos	39
Exclusive App	41
Trademarks & Copyrights	42
GPS	43
Troubleshooting	44
Specifications	45

Declaration of Conformity with regard to the Radio Equipment Directive 2014/53/EU

Manufacturer:

Pioneer Corporation

28-8, Honkomagome 2-chome, Bunkyo-ku,
Tokyo 113-0021, JAPAN

EU Authorised Representative's & Importer:

Pioneer Europe NV

Haven 1087, Keetberglaan 1, B-9120 Melsele, Belgium
<https://www.pioneer-car.eu/eur/>

[*] VREC-Z810SH

English:

Hereby, Pioneer declares that the radio equipment type [*] is in compliance with Directive 2014/53/EU.

The fully text of the EU declaration of conformity is available at the following internet address:

<https://www.pioneer-car.eu/eur/compliance>

Suomi:

Pioneer vakuuttaa, että radiolaitetyyppi [*] on direktiivin 2014/53/EU mukainen.

EU-vaatimustenmukaisuusvakuutuksen täysimittainen teksti on saatavilla seuraavassa internetosoitteessa:

<https://www.pioneer-car.eu/eur/compliance>

Nederlands:

Hierbij verklaar ik, Pioneer, dat het type radioapparatuur [*] conform is met Richtlijn 2014/53/EU.

De volledige tekst van de EU-conformiteitsverklaring kan worden geraadpleegd op het volgende internetadres:

<https://www.pioneer-car.eu/eur/compliance>

Français:

Le soussigné, Pioneer, déclare que l'équipement radioélectrique du type [*] est conforme à la directive 2014/53/UE.

Le texte complet de la déclaration UE de conformité est disponible à l'adresse internet suivante:

<https://www.pioneer-car.eu/eur/compliance>

Svenska:

Härmed försäkrar Pioneer att denna typ av radioutrustning [*] överensstämmer med direktiv 2014/53/EU.

Den fullständiga texten till EU-försäkran om överensstämmelse finns på följande webbadress:

<https://www.pioneer-car.eu/eur/compliance>

Dansk:

Hermed erklærer Pioneer, at radioudstyrstypen [*] er i overensstemmelse med direktiv 2014/53/EU.

EU-overensstemmelseserklæringens fulde tekst kan findes på følgende internetadresse:

<https://www.pioneer-car.eu/eur/compliance>

Deutsch:

Hiermit erkläre Pioneer, dass der Funkanlagentyp [Bezeichnung] der Richtlinie 2014/53/EU entspricht.

Der vollständige Text der EU-Konformitätserklärung ist unter der folgenden Internetadresse verfügbar:

<https://www.pioneer-car.eu/eur/compliance>

Ελληνικά:

Με την παρούσα ο/η Pioneer, δηλώνει ότι ο ραδιοεξοπλισμός [*] πληροί την οδηγία 2014/53/ΕΕ.

Το πλήρες κείμενο της δήλωσης συμμόρφωσης ΕΕ διατίθεται στην ακόλουθη ιστοσελίδα στο διαδίκτυο:

<https://www.pioneer-car.eu/eur/compliance>

Italiano:

Il fabbricante, Pioneer, dichiara che il tipo di apparecchiatura radio [*] è conforme alla direttiva 2014/53/UE.

Il testo completo della dichiarazione di conformità UE è disponibile al seguente indirizzo Internet:

<https://www.pioneer-car.eu/eur/compliance>

Español:

Por la presente, Pioneer declara que el tipo de equipo radioeléctrico [*] es conforme con la Directiva 2014/53/UE.

El texto completo de la declaración UE de conformidad está disponible en la dirección Internet siguiente:

<https://www.pioneer-car.eu/eur/compliance>

Português:

O(a) abaixo assinado(a) Pioneer declara que o presente tipo de equipamento de rádio [*] está em conformidade com a Diretiva 2014/53/UE.

O texto integral da declaração de conformidade está disponível no seguinte endereço de Internet:

<https://www.pioneer-car.eu/eur/compliance>

Čeština:

Tímto Pioneer prohlašuje, že typ rádiového zařízení [*] je v souladu se směrnici 2014/53/EU.

Úplné znění EU prohlášení o shodě je k dispozici na této internetové adrese:

<https://www.pioneer-car.eu/eur/compliance>

Esti:

Käesolevaga deklareerib Pioneer, et käesolev raadioseadme tüüp [*] vastab direktiivi 2014/53/EL nõuetele.

ELi vastavusdeklaratsiooni täielik tekst on kätesaadav järgmisel internetiaadressil:

<https://www.pioneer-car.eu/eur/compliance>

Magyar:

Pioneer igazolja, hogy a [*] típusú rádióberendezés megfelel a 2014/53/EU irányelvnek.
Az EU-megfelelőségi nyilatkozat teljes szövege elérhető a következő internetes címen:
<https://www.pioneer-car.eu/eur/compliance>

Latviešu valoda:

Ar šo Pioneer deklarē, ka radioiekārta [*] atbilst Direktīvai 2014/53/ES.
Pilns ES atbilstības deklarācijas teksts ir pieejams šādā interneta vietnē:
<https://www.pioneer-car.eu/eur/compliance>

Lietuvių kalba:

Aš, Pioneer, patvirtinu, kad radijo įrenginių tipas [*] atitinka Direktyvą 2014/53/ES.
Visas ES atitikties deklaracijos tekstas prieinamas šiuo interneto adresu:
<https://www.pioneer-car.eu/eur/compliance>

Malti:

B'dan, Pioneer, niddikjara li dan it-tip ta' tagħmir tar-radju [*] huwa konformi mad-Direttiva 2014/53/UE.
It-test kollu tad-dikjarazzjoni ta' konformità tal-UE huwa disponibbli f'dan l-indirizz tal-Internet li ġej:
<https://www.pioneer-car.eu/eur/compliance>

Slovenčina

Pioneer týmto vyhlasuje, že rádiové zariadenie typu [*] je v súlade so smernicou 2014/53/EÚ.
Uplné EÚ vyhlásenie o zhode je k dispozícii na tejto internetovej adrese:
<https://www.pioneer-car.eu/eur/compliance>

Slovenščina:

Pioneer potrjuje, da je tip radijske opreme [*] skladen z Direktivo 2014/53/EU.
Celotno besedilo izjave EU o skladnosti je na voljo na naslednjem spletnem naslovu:
<https://www.pioneer-car.eu/eur/compliance>

Română:

Prin prezenta, Pioneer declară că tipul de echipamente radio [*] este în conformitate cu Directiva 2014/53/UE.
Textul integral al declarației UE de conformitate este disponibil la următoarea adresă internet:
<https://www.pioneer-car.eu/eur/compliance>

Български:

С настоящото Pioneer декларира, че този тип радиосъоръжение [*] е в съответствие с Директива 2014/53/ЕС.
Цялостният текст на ЕС декларацията за съответствие може да се намери на следния интернет адрес:
<https://www.pioneer-car.eu/eur/compliance>

Polski:

Pioneer niniejszym oświadcza, że typ urządzenia radiowego [*] jest zgodny z dyrektywą 2014/53/UE.
Pełny tekst deklaracji zgodności UE jest dostępny pod następującym adresem internetowym:
<https://www.pioneer-car.eu/eur/compliance>

Norsk:

Herved Pioneer erklærer at radioutstyr type [*] er i samsvar med direktiv 2014/53 / EU.
Den fullstendige teksten i EU-samsvarserklæringen er tilgjengelig på følgende nettadresse :
<https://www.pioneer-car.eu/eur/compliance>

Íslenska:

Hér með Pioneer lýsir yfir að tegund þráðlausan búnað [*] er í samræmi við tilskipun 2014/53/ESB.
The fullur texti af ESB-samræmisýrslýnginu er í boði á eftirfarandi veffangi:
<https://www.pioneer-car.eu/eur/compliance>

Hrvatski:

Pioneer ovime izjavljuje da je radijska oprema tipa [*] u skladu s Direktivom 2014/53/EU.
Cjeloviti tekst EU izjave o skladnosti dostupan je na sljedećoj internetskoj adresi:
<https://www.pioneer-car.eu/eur/compliance>

Türk:

Burada, Pioneer radyo ekipmanı turunun [*] 2014/53/EU direktiflerine uyumlu olduğunu beyan eder.
Avrupa uyumluluk beyanının tam metni belirtilen internet sitesinde mevcuttur :
<https://www.pioneer-car.eu/eur/compliance>

Declaration of Conformity with regard to Radio Equipment Regulations 2017

Manufacturer:

Pioneer Corporation

28-8, Honkomagome 2-chome, Bunkyo-ku,
Tokyo 113-0021, JAPAN

UK Authorised Representative's & Importer:

Pioneer Europe NV

Salamanca, Wellington Street, Slough, SL1 1YP, UK
<http://www.pioneer-car.eu>

[*] VREC-Z810SH

Hereby, Pioneer declares that the radio equipment type [*] is in compliance with UK SI 2017 No. 1206.

The full text of the UK declaration of conformity is available at the following internet address:

<http://www.pioneer-car.eu/compliance>

Precaution

Certain country and state laws may prohibit or restrict the placement and use of this product in your vehicle. Please comply with all applicable laws and regulations regarding the use, installation and operation of this product. It is the user's responsibility in compliance with all applicable laws and ordinance.

Information for users on collection and disposal of old equipment and used batteries

(Symbol for equipment)



(Symbol examples for batteries)



These symbols on the products, packaging, and/or

accompanying documents mean that used electrical and electronic products and batteries should not be mixed with general household waste.

For proper treatment, recovery and recycling of old products and used batteries, please take them to applicable collection points in accordance with your national legislation.

By disposing of these products and batteries correctly, you will help to save valuable resources and prevent any potential negative effects on human health and the environment which could otherwise arise from inappropriate waste handling.

For more information about collection and recycling of old products and batteries, please contact your local municipality, your waste disposal service or the point of sale where you purchased the items

These symbols are only valid in the European Union.

For countries outside the European Union:

If you wish to discard these items, please contact your local authorities or dealer and ask for the correct method of disposal.

WARNING

- Do not allow the battery to be exposed to fire or excessive heat or to become crushed or cut, or dispose of the battery in a fire or hot oven, which could result in an explosion.
- Do not expose a battery to high or low extreme temperatures during use, storage or transportation.

CAUTION

- The graphical symbol  placed on the product means direct current.

Safety Precautions

Always observe the precautions described here to prevent harm to yourself and others and to prevent damage to property before it happens.

Important safeguards

WARNING

- Do not install this product in your vehicle if its location or use would obstruct the driver's clear view of the road or the operation of any vehicle airbag. It is also the driver's responsibility to know and comply with the laws, rules, and regulations of the driving location, including, for example, passenger privacy rights, and not to use the device in any location where its installation or use is prohibited.
- Usage of the Advanced Driver Assistance Systems (ADAS) features in this product is not a substitute for driver awareness and is not for preventing accidents. The system alerts are to be used as a guidance only.
- It is the user's responsibility in compliance with all applicable laws and ordinance.
- Pioneer is not liable for any damage, due to installation other than described, or use of the product. Pioneer does take responsibility whatsoever for any damage or losses incurred as a result.
- It is the user's responsibility to drive whilst keeping a safe distance between vehicles, whilst correctly judging the road, traffic and weather, and surrounding conditions.
- Do not operate this product if doing so will divert your attention in any way from the safe operation of your vehicle. Always observe safe driving rules and follow all existing traffic regulations. If you experience difficulty in operating this product or reading the display, park your vehicle in a safe location and apply the handbrake before making the necessary adjustments.
- The laws in your location may require you to provide notice to passengers that a recording device is in use. If so, you should place the notice sticker in a location clearly visible to your passengers.
- Any obstruction of or other interference with the airbag, either deployed or non-deployed, or with the clear view of the road must be avoided and, accordingly, professional installation is required.
- We recommend that this product be set up and installed by a technician who has special training and experience in mobile electronics.
- Do not locate this product between the front windscreen and car sun shade. This may cause heat to build up, resulting in deformation or malfunction of this product. If you want to use the sun shade when using Security Mode, cut out the Dash Camera part or so.

Important safety information

WARNING

- Do not allow this product to come into contact with liquids. Electrical shock could result. Also, damage to the product, smoke, and overheating could result from contact with liquids.
- If liquid or foreign matter should get inside this product, park your vehicle in a safe place, turn the ignition switch off (ACC OFF) and consult your dealer or the nearest authorised Pioneer Service Station. Do not use this product in this condition because doing so may result in a fire, electric shock, or other failure.
- If you notice smoke, a strange noise or odour from this product, or any other abnormal signs on the LCD screen, turn off the power immediately and consult your dealer or the nearest authorised Pioneer Service Station. Using this product in this condition may result in permanent damage to the system.
- Do not disassemble or modify this product, as there are high-voltage components inside which may cause an electric shock. Be sure to consult your dealer or the nearest authorised Pioneer Service Station for internal inspection, adjustments or repairs.

Before using this product, be sure to read and fully understand the following safety information:

- Do not operate this product if doing so will divert your attention in any way from the safe operation of your vehicle. Always observe safe driving rules and follow all existing traffic regulations. If you experience difficulty in operating this product or reading the display, park your vehicle in a safe location and apply the handbrake before making the necessary adjustments.
- Never set the volume of this product so high that you cannot hear outside traffic and emergency vehicles.
- Keep this manual handy as a reference for operating procedures and safety information.
- Certain functions (such as viewing of screen and certain button operations) offered by this product could be dangerous (possibly resulting in serious injury or death) and/or unlawful if used while driving.

To ensure safe driving

WARNING

- In some countries the viewing of video image on a display inside a vehicle even by persons other than the driver may be illegal. Where such regulations apply, they must be obeyed.

Precautions before connecting the system

CAUTION

- Firmly install this product so it does not fall off the windscreen. If this product is not firmly installed, it may fall off the windscreen while driving and cause an accident. Periodically inspect this product.
- Secure all wiring with cable clamps or electrical tape. Do not allow any bare wiring to remain exposed.
- It is extremely dangerous to allow cables to become wound around the steering column or gearstick. Be sure to install this product, its cables, and wiring away in such so that they will not obstruct or hinder driving.
- Make sure that the cables and wires will not interfere with or become caught in any of the vehicle's moving parts, especially the steering wheel, gearstick, handbrake, sliding seat tracks, doors, or any of the vehicle's controls.
- Do not route wires where they will be exposed to high temperatures. If the insulation heats up, wires may become damaged, resulting in a short circuit or malfunction and permanent damage to the product.
- Do not shorten any cables. If you do, the protection circuit (fuse holder, fuse resistor or filter, etc.) may fail to work properly.
- Never feed power to other electronic products by cutting the insulation of the power supply cable of this product and tapping into the cable. The current capacity of the cable will be exceeded, causing overheating.

To prevent damage

WARNING

- When replacing the fuse, be sure to only use a fuse of the rating prescribed on this product.

Precautions before installation

CAUTION

Never install this product in places where, or in a manner that:

- Could injure the driver or passengers if the vehicle stops suddenly.
- May interfere with the driver's operation of the vehicle, such as on the floor in front of the driver's seat, or close to the steering wheel or gearstick.
- To ensure proper installation, be sure to use the supplied parts in the manner specified. If any parts are not supplied with this product, use compatible parts in the manner specified after you have the parts' compatibility checked by your dealer. If parts other than supplied or compatible ones are used, they may damage internal parts of this product or they may work loose and the product may become detached.
- Do not install this product where it may
 - (i) obstruct the driver's vision,
 - (ii) impair the performance of any of the vehicle's operating systems or safety features, including airbags, hazard lamp buttons or
 - (iii) impair the driver's ability to safely operate the vehicle.
- Never install this product in front of or next to the place in the dashboard, door, or pillar from which one of your vehicle's airbags would deploy. Please refer to your vehicle's owner's manual for reference to the deployment area of the frontal airbags.
- Consult with your nearest dealer if installation requires drilling holes or other modifications of the vehicle.
- Before making a final installation of this product, temporarily connect the wiring to confirm that the connections are correct and the system works properly.
- Do not install this product in places subject to high temperatures or humidity, such as:
 - Places close to a heater, vent or air conditioner.
 - Places that may be exposed to rain, such as close to the door or on the vehicle's floor.

Disclaimer

- Given the large number of variables and conditions that can be involved in an accident, Pioneer cannot guarantee that every accident or occurrence will trigger the recording feature in this device.
- This product features may not operate properly due to the effects of settings, how this product is installed, the condition of the microSD card, and driving conditions (including the road conditions).
- If brightly coloured objects are placed on the dashboard, they may be reflected in the front windscreen and the camera image. Do not place brightly coloured objects on the dashboard.
- This product is not guaranteed to be effective as evidence in an accident.
- This product is not guaranteed to save video in all situations.
- You may not be able to recognise the conditions in the front of the vehicle in recorded video, depending on the ambient conditions, such as the weather and time of day.
- LED traffic signals or street lamps on the road may appear as flashing or flickering when recorded with this product. The colour may also not be correctly identifiable. Pioneer Corporation accepts no responsibility whatsoever for these phenomena.
- This product saves video before and after an accident occurs by detecting the impact (acceleration) with the G-sensor (accelerometer). However, this product is not guaranteed to save video in all situations.
- Pioneer accepts no responsibility whatsoever for product failures or damage that occur due to the microSD card wearing out.
- Pioneer does not make any assurances that microSD card problems will be repaired by formatting the card. Pioneer bears no responsibility for files that are erased from the microSD card or damage that occurs from formatting the card. Format the microSD card according to your own judgement and at your own responsibility.
- Always install this product in the specified installation position to ensure a safe field of view while driving and to achieve full performance from the product. Pioneer is not liable for any damages due to faulty or improper installation or use of the product.

How to read this Manual

Notation	Meaning
	These symbols are used to draw your attention to items you should be aware of when using this product and items you should be aware of to maintain its performance.
Note /Notes	Notes provide useful tips and extra information about product features.
[○○]	Square brackets are used to indicate selectable items displayed on the screen.
→ “○○○○”	Quotation marks are used to indicate references and settings.

- The illustrations and example screens used in this manual may differ from the actual product.
- The actual screens of the product may be changed without prior notification for the purpose of improvements to product performance and features.
- In this manual, the microSDHC/SDXC memory card is referred to as “the microSD card” for convenience.

Usage Precautions

⚠ Precautions When Handling this product

- The driver may manually set the device to save video to assist in the monitoring of driver performance.
- There are limits to the scope of video that can be recorded with this product (→ **“Specifications”**). First check the video that will be recorded before using this product.
- Do not use it in high temperature above 60 °C or low temperature below -20 °C and high humidity.
- Be careful not to infringe on the privacy of any subject in video recorded with this product when using said video. You are fully responsible for the use of said video. Video recorded with this product may include personal information, such as numbers on number plates.
- If the power supply to this product is stopped by turning off the vehicle engine when the holding capacitor is not sufficiently charged, situations such as immediately after purchase, the recording time may be shortened or recording may not be possible.
- For power supply, be sure to use the power cable that is provided with this product.
- Pioneer does not offer a data recovery service for corrupted or deleted files.
- The storage areas on the microSD card are split into the four areas shown in the following diagram according to the type of recording.

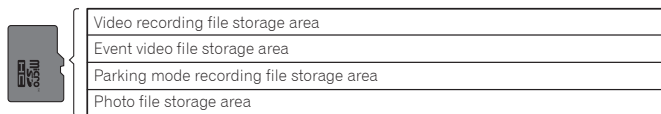

- Note that files will be overwritten when there is insufficient free space in the file storage areas. We recommend that you back up any important files you want to keep. → **“Backing Up Recorded Files”**
- To ensure that important files, such as files containing records of accidents, are not overwritten, always turn the power off before removing the microSD card and store the card in a safe place. → **“Inserting and Ejecting the microSD Card”**
- You can view video files on your PC. However, the video may stutter or stop depending on the performance of the PC.
- If this product is used near another device that uses GPS, such as a car navigation system, that device may temporarily be unable to receive radio waves from GPS satellites due to radio interference. There may also be a negative impact on the functions of surrounding devices.
- Do not touch the lens with your hands. Wipe the lens off with a soft cloth if you touch it.
- Do not replace the backup lithium rechargeable battery. If required, please contact the dealer or the nearest authorized Pioneer Service for replacement in the event of a malfunction, as data loss may occur.

Precautions When Handling the microSD Card

- Keep the microSD card out of the reach of small children to prevent them from accidentally swallowing it.
- To prevent data loss and damage to the microSD card, never remove it from this product while data is being transferred.
- If data loss or corruption occurs on the microSD card for any reason, it is usually not possible to recover the data. Pioneer accepts no liability for damages, costs or expenses arising from data loss or corruption.
- Never insert or eject an microSD card while driving.
- This product supports the following microSD cards.

	microSDHC™	microSDXC™
Capacity	32 GB	64 GB to 256 GB
File system	FAT32	
Speed class	Class 10 or better	

The microSD card is a consumable product.

Not all microSD cards are guaranteed to work with this product.

- Pioneer does not guarantee microSD Card compatibility.
- Format the microSD card before using it. Do not use a microSD card that contains other data, such as that from a PC.
- Periodically format the microSD card.
- Do not eject the microSD card when it is being accessed. The file or card may be corrupted.
- Even if the microSD card is used normally, you may no longer be able to write data to the card or erase data from the card normally.
- The service life of the microSD card is not covered under the warranty.
- The microSD card is a consumable part. We recommend that you regularly replace the microSD card with a new card. If you use the microSD card for a long period of time, this product may no longer be able to save data to the card correctly due to bad sectors, or an error may occur and the card will no longer be usable.
- On rare occasions, a microSD card that is recognised by your computer may not be recognised by this product. In this case, depending on the problem with the microSD card, this product may be able to recognise the card by formatting it with this product format feature → **“This Product Settings” - “Configurable Features” - “Values” - “System” - “Format SD Card”**. However, all files, including protected files, saved to the microSD card will be erased when it is formatted. Always back up the files on the microSD card before formatting it.
- Pioneer Corporation does not make any assurances that microSD card problems will be repaired by formatting the card. Pioneer Corporation bears no responsibility for files that are erased from the microSD card or damage that occurs from formatting the card. Format the microSD card according to your own judgement and at your own responsibility.

Check the Accessories

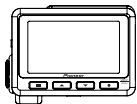

Main Unit×1



Mounting Bracket×1



Power Cable (3.3 m)×1



Quick Start Guide×1



Warranty×1



Cleaning Cloth×1

Before Installing the Product

WARNING

- When installing the product on vehicles installed with an air bag, never install on the cover of the air bag and at locations that might obstruct the deployment of the air bag. Doing so might prevent the air bag from being deployed normally, cause the product to fly out due to air bag deployment, and cause accident and injury.

CAUTION

- First check with the vehicle manufacturer for precautions related to the installation work when installing the product in a vehicle equipped with airbags. Otherwise there is a risk of airbag malfunction.
- Always use the included parts as specified. There is a risk of product failure if other parts are used.
- Install this product in a location where it will not hinder vehicle equipment and the ability to drive the vehicle.

Installation Precautions

- Main unit and 2nd camera (sold separately) are for installation to the inside of the front and rear windows only. Do not install it anywhere else inside or outside of the vehicle.
- When installing the main unit to the inside of the front windscreen, be sure to install it to the specified positions of the front windscreen and within the specified dimensions.
- When installing the 2nd camera (sold separately) to the inside of the rear window, pay attention to the following points.
 - Avoid installing the 2nd camera (sold separately) on heating wires.
 - If the vehicle is provided with a rear wiper, install so that it is within the wiping range of the wiper. (Rain and stains make it difficult to see the image)
 - Install the 2nd camera (sold separately) as far as possible from the high mount stop lamp.
- Depending on the vehicle, installation at the specified location and within the specified dimensions may not be possible. For details, consult with your dealer.
- Do not cover this product and 2nd camera (sold separately) or get the lens dirty.
- Do not place reflective objects near the lens.
- Take care when handling this product and 2nd camera (sold separately) so that they do not drop and you do not touch the lens.
- Recording quality may be affected if the front windscreen of the vehicle is coated or has been specially treated.
- This product may not be able to receive GPS signals if the front windscreen of the vehicle has been specially treated. Check the GPS reception status indicator displayed on the screen of this product. If a GPS signal cannot be received, this product cannot be installed in this vehicle. → ***“Using this product” - “Status Display”***
- Choose a working location free from dust and debris in the air.
- When the temperature is low or there is condensation on the glass, turn on the heater and defroster to warm up the window in order to prevent poor adhesion of the double-sided tape.

Double-sided tape cannot be re-applied once it is peeled off as peeling off weakens its adhesive strength. Be sure to temporarily fasten this product and 2nd camera (sold separately) and sufficiently consider routing of cables before applying double-sided tape.

Installation Tips

Before Installing and Securing the Product

First, temporarily connect this product and confirm that it operates correctly, and then install it. If the product does not operate correctly, check again if there is a mistake in the connection.

Before Applying Double-sided Tape

Clean the location where the double-sided tape will be applied.

WARNING

- Install firmly so that it does not come off. Incorrect installation may cause this to peel off while driving and cause an accident. Inspect the installation state from time to time.

Installation

Specified Installation Position on Front Windscreen

- When installing this product on the inside of the front windscreen, install in a vehicle and in a position that satisfies all of the following conditions.
- A position where this entire product is within 20 % of the top edge of the height of the front windscreen (range within 20 % of the actual length, excluding parts overlapping weatherstrips, mouldings, etc. and masked parts) or are in the shadow of the rear view mirror as viewed from the driver's seat. Note that "20 %" as described above is a rough estimate. Please install the product in accordance with your country's laws and regulations.
- A position where the lens part of this product is within the wiping range of the wiper.
- A position where the lens part of this product does not hang over the sunshade and black ceramic lines/black ceramic pattern.
- A position where this product faces in the horizontal direction to the front and the lens is in a central position on the windscreen.
- A position where the power cable can be routed without unnecessary force.

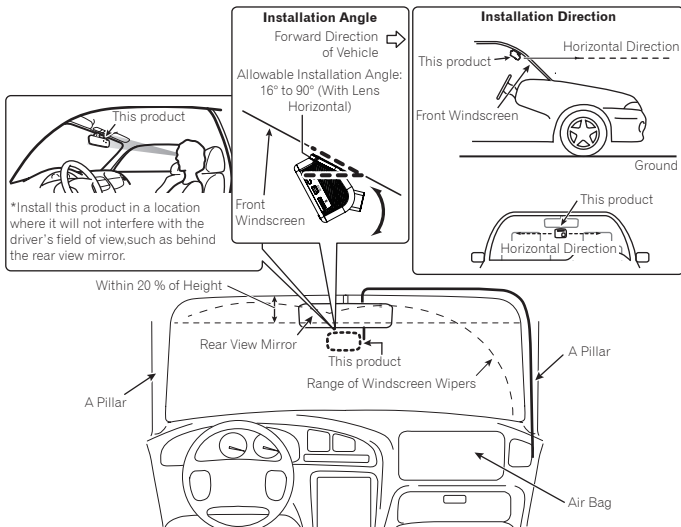

⚠ IMPORTANT

- Always install this product in the specified installation position to ensure a safe field of view while driving and to achieve full performance from the product.
- For vehicles equipped with driver-assistance systems, there may be areas where the installation of accessory items is prohibited. For details, please refer to the instruction manual of your vehicle.
- Installing the Dash Camera main unit or cables near the film antenna element may affect the TV reception sensitivity.

Recommended Installation Position on Rear Windscreen

For installation on the rear glass, a 2nd camera (sold separately) is required. If installing only this product, then skip the instructions regarding installation on the rear glass.

When installing the 2nd camera (sold separately) on the inside of the rear window, installation in a vehicle and in a position that satisfies all of the following conditions is recommended.

- A position where the lens part of the 2nd camera (sold separately) is within the wiping range of the wiper.
- A position where the 2nd camera (sold separately) faces in the horizontal direction to the rear and the lens is in a central position on the rear windscreen.
- A position where the lens part of the 2nd camera (sold separately) and the double-sided tape do not overlap the heating wires.
- A position where the 2nd camera (sold separately) connection cable can be routed without unnecessary force.

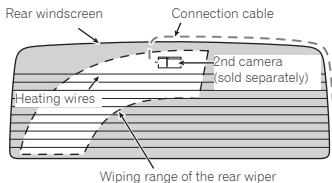

1 Clean the installation area of dirt and oils using the included cleaning cloth.

Front windscreen

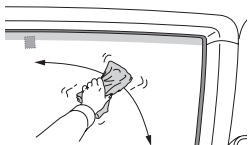

Rear windscreen

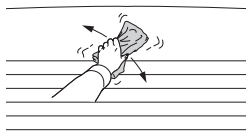

2 Install this product.

- ① : Set the mounting bracket on the main unit.
- ② : Peel off the double-sided tape release paper from the mounting bracket.
- ③ : Install at the specified position of the front windscreen.

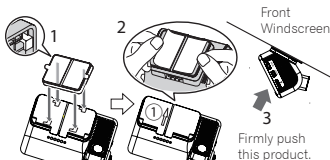

⚠ CAUTION

- Make sure that the surface of the front windscreen is clean and dry before applying the tape.
- Firmly push the area around the LCD. Next, remove this product from the mounting bracket, directly press the mounting bracket against the tape. In this way, the product can be firmly installed on the windscreen.
- Never touch the surface of the LCD.
- Use extreme care as the double-sided tape on the mounting bracket is extremely strong, and it will be difficult to reapply the tape once it has been applied.
- To ensure the installation strength of the adhesive tape, leave this product for 24 hours after application before using it.

3 Install the 2nd camera (Only when installing the 2nd camera (sold separately)).

- ① : Peel off the double-sided tape release paper from the 2nd camera (sold separately).
- ② : Install in the specified position on the rear window so the image of the 2nd camera (sold separately) is displayed horizontally with the flat surface shown in the figure (the △ on the side faces up) facing upwards.

Note

- You can use the dedicated app to display the 2nd camera's (sold separately) image horizontally to support installation. → **"Exclusive App"**

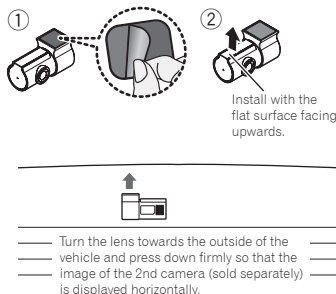
**⚠ CAUTION**

- The rear camera image is not a mirrored view on the dash camera's main unit screen. Please do not use the rear camera image for purposes such as parking, changing lanes, or backing up your vehicle.

4 Connect the Dash Camera main unit, power cable, and 2nd camera connection cable (included with the 2nd camera (sold separately)).

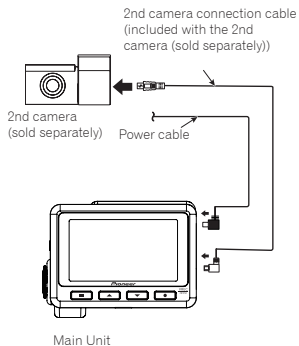

5 Route the power cable and 2nd camera connection cable (included with the 2nd camera (sold separately)) along the passenger side.

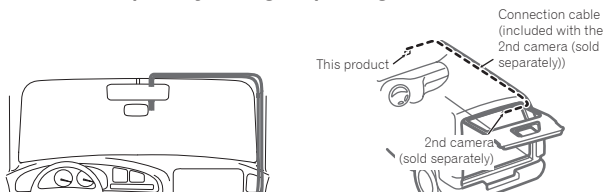



6 Connect the power cable.

→ *“Connecting the Power Cable”*

7 Turn the vehicle engine on to display the recording screen.

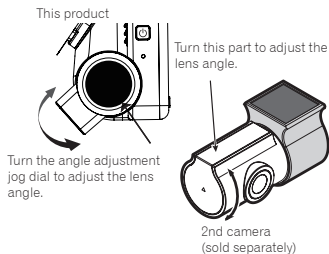
8 Adjust the angle of the lens so that video outside and inside the vehicle is properly displayed.



During driving, the lens of this product has to be turned towards the outside of the vehicle. To switch between the Dash Camera main unit image and the 2nd camera (sold separately) image, press the  button. → **“Function Buttons”**

Note

- A protective film is applied to the lens when the product is purchased. Peel off this film.

Connecting the Power Cable

Be sure to disconnect the \ominus terminal of the vehicle's battery before connecting the power cable.

By using the power cable to draw power directly from the vehicle, this product can detect and record vehicle movement caused by vibration even when the vehicle's engine is turned off.

→ **"This Product Settings" - "Configurable Features" - "Video Setting" - "Parking Mode (Security Mode)"**

English

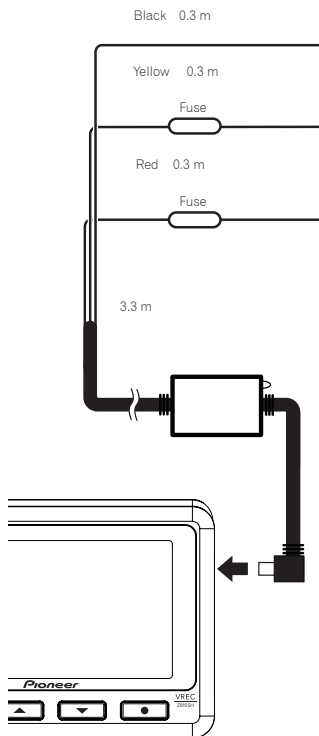

Ground (Black)

Securely connect to the metal part of the vehicle body. To prevent noise, connect as close to the navigation unit as possible.

+ Battery power supply (Yellow)

Always connect to the power circuit supplied with power from the battery, regardless of whether the vehicle engine switch is ON or OFF.

Accessory power supply (Red)

Connect to the power circuit supplied with power when the vehicle engine switch is turned to the ACC position.

Never install the accessory power supply to a vehicle that does not have an ACC position on the engine switch. Doing so may lead to a dead battery.

Note:

Connect the red and yellow lead wires to the terminals after wiring through the vehicle's fuse unit.

⚠ Connection Precautions

- To prevent fuming and damage to the product, be sure to first securely connect the black lead wire (Ground) of this product to the metal part of the vehicle body. Connect separate black lead wires (Ground) for products with a high current consumption such as a power amplifier. When setting up connections all at once, there is a risk of fuming or damage to the product when screws loosen or come off completely.

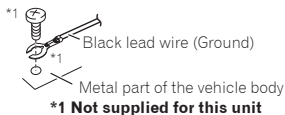
**⚠ Caution**

This product is not compatible with cigar chargers. Only use the cable supplied by Pioneer in the box.

Part Names

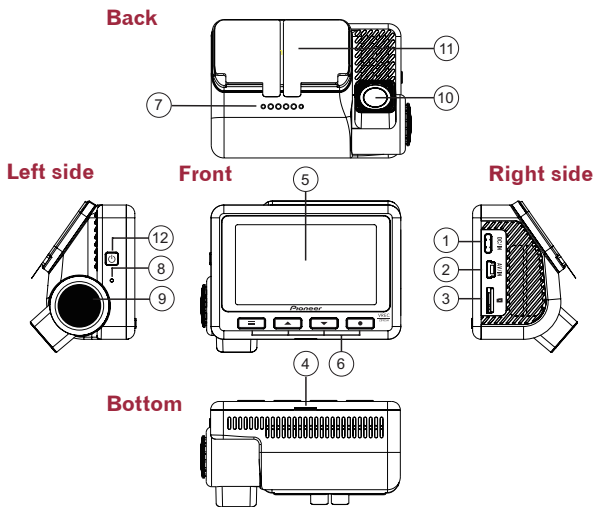

① Power Port

Connect the power cable.

② 2nd Camera Connection Terminal

Use the 2nd camera connection cable (included with the 2nd camera (sold separately)) to connect to the connection terminal on the 2nd camera (sold separately).

③ microSD Card Slot

④ System Indicator

⑤ LCD

⑥ Function Buttons

⑦ Speaker

⑧ Microphone

⑨ Angle Adjustment Jog Dial

The angle of the lens can be adjusted by turning this dial.

⑩ Lens

⑪ Mounting Bracket

⑫ On/Off Power Button

Short press : Toggle screen ON or OFF

Long press for 3s : Power ON or OFF the unit

Long Press for 10s : Reset

Inserting and Ejecting the microSD Card

Turn off the power to this product when inserting and removing the microSD card. → **“Manually Turning the Power On and Off”**

Inserting the microSD Card

Hold the top edge of the microSD card, position the microSD card so that the label is facing the display side of this product, and slowly insert it into the microSD card slot until it clicks.

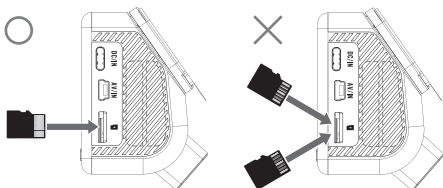

⚠ CAUTION

- Do not insert the microSD card at an angle. Doing so may cause damage.

Ejecting the microSD Card

Slowly push in the top edge of the microSD card until it clicks (①). The lock will be released. Pull out the microSD card (②).

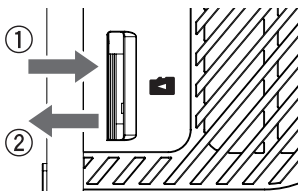

⚠ CAUTION

- Ensure care is taken when handling the microSD card, as it could become hot after being written.

Backing Up Recorded Files

When the free space of the file storage areas is low, files are deleted from the oldest file. We recommend that you back up any important files you want to keep with the following procedure.

Note

- Prepare a spare microSD card in advance.

1 Replace the microSD card.

Stop the vehicle in a safe location. Then turn off this product power, eject the microSD card, and replace it with a spare microSD card.

Note

- After microSD card replacement, perform a format before use.

2 Copy or move the files to a PC.

Insert the microSD card into a PC, using a commercially available SD™ card adapter if necessary. Copy or move the videos and photo files to back up to a suitable location on the PC.

Folder and File Structure

The structure of folders and files in a microSD card is as follows.

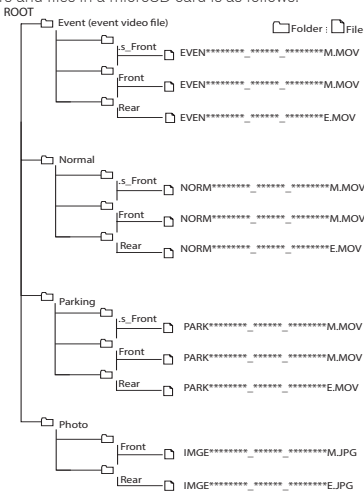

Notes

- "M" is the symbol that indicates the product camera. "E" is the symbol that indicates the 2nd camera (sold separately).
- The year, month, day, hours, minutes, seconds and index number are automatically assigned at "*****_*****_*****".

Using this product

Before using this product, first stop the vehicle in a safe location and apply the handbrake.

This product Power

This product starts when the vehicle's engine is turned on (ACC ON), and it automatically starts recording. (Video recording)

→ ***"Using this product" - "Video Recording"***

Manually Turning the Power On and Off

This product can be manually turned on and off.

When the main unit power is off: Long press ON/OFF Button for 3 seconds to start up.

When the main unit power is on: Long press ON/OFF Button for 3 seconds to shut down.

System Indicator Display

The operating status of this product is displayed with the system indicator.

System Indicator	Menu Displayed/ During Playback	Video Recording	Recording Event	Under parking surveillance	Error Has Occurred (Including microSD Card not Inserted)
Illuminated green	—	○	—	—	—
Illuminated red	—	—	○	○	—
Blinking red	—	—	—	—	○

Function Buttons

The functions of the function buttons are indicated by the icons displayed at the bottom of the screen. The functions of the buttons will depend on the displayed screen. (Icons are not displayed on some screens.)

In the playback screen or MENU screen, pressing the  function button returns you to the previous screen.

Recording

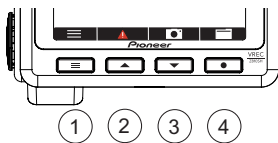

- ① Main menu display
 - ② Manual recording of an emergency video
 - ③ Take photo
 - ④ Open video playback menu
- Switch camera image if optional rear camera is connected*

* Switching between the Dash Camera main unit image and the 2nd camera (sold separately) image is only possible if the 2nd camera (sold separately) is connected.

During playback

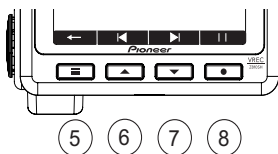

- ⑤ Back
- ⑥ Previous file
- ⑦ Next file
- ⑧ Play/stop, delete

During MENU screen display

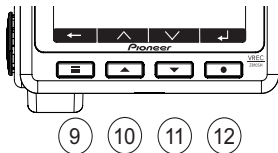

- ⑨ Back
- ⑩ Up*
- ⑪ Down*
- ⑫ Confirm

* When the volume or sensitivity MENU screen is displayed, increase or decrease the volume or sensitivity.

Status Display

The status display shows the operating status of this product.

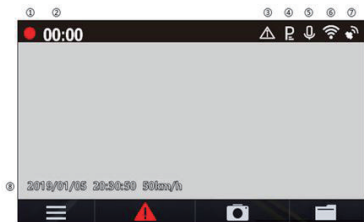

- ① Recording in progress
- ② Elapsed recording time
- ③ Event recording status
- ④ Parking mode
- ⑤ Sound recording*1
- ⑥ Wi-Fi connection status*2
- ⑦ GPS reception status*3
- ⑧ Date/Time/Vehilce speed

- *1 A red “\” is displayed when sound recording is set to off.
- *2 During a Wi-Fi connection, this is displayed in green, and when Wi-Fi is disconnected, this is displayed in white. A red “x” is displayed when Wi-Fi connection is set to off.
- *3 During GPS reception, this is displayed in green, and when GPS cannot be received, this is displayed in white.

Video Recording

Recording automatically starts when this product is started. The recorded video is saved to the microSD card as one file of the set increment of time (default: 3 minutes), and when the microSD card runs out of free space, the files are overwritten starting from the oldest file.

Notes

- You can change the video recording time.
→ **“This Product Settings” - “Configurable Features” - “Values” - “Video Recording” - “Video Clip Length”**
- Video recording will stop under the following circumstances.
 - When the MENU screen is displayed
 - When the power supply is stopped
 - When security mode has started
 - When the microSD Card is removed
- The recording time may differ depending on the conditions.

Event Recording

Automatic Recording by Detecting Impacts (Event Recording)

The video recording file when an impact is detected by this product (the Dash Camera), such as an impact with another vehicle, is recorded as an event video file to the "Event" folder.

The number of event video files and recording times will differ depending on when an impact is detected. If an impact is detected, the period from 30 seconds before to 30 seconds after impact detection is recorded as an event video file.

Manual Recording (Manual Event Recording)

If the manual record button  is pressed during video recording, the period from at least 30 seconds before to 30 seconds after the manual record button is pressed is recorded as an event video file.

Note

- You can adjust the sensitivity for detecting an impact.
→ **"This Product Settings" - "Configurable Features" - "Video Setting" - "G-Sensor"**

Security Mode

When the power supply to this product is turned off (vehicle engine is turned off), Security Mode is activated.

When this device detects vehicle movement caused by vibration while Security Mode is activated, that event is saved for 60 seconds as a parking mode file. After recording has completed, the Dash Camera will automatically shut down. If there is parking surveillance video recorded, the user is prompted with the option to view the recorded video.

Notes

- When the battery voltage drops below 12.2 V, security mode standby and recording are stopped.
- In this manual, Parking Mode is also referred to as Security Mode as the feature name.
- The Security Mode can be set to OFF or ON (Low/Mid/High)
- You can adjust the sensitivity for detecting vibration.
→ **"This Product Settings" - "Configurable Features" - "Video Setting" - "Parking Mode (Security Mode)"**
- Vibration that is detected during the first 3 minutes after power supply to this device is stopped and during the last 3 minutes before power supply is started, is not covered by the notification message display feature. However, the recorded files are also stored in the Parking folder.
- The recording time may differ depending on the conditions.
- While recording a parking event, screen will remain off.

Photography Feature

Photos can be taken during video recording or event recording by pressing the  function button.

Playing Recorded Files

You can play recorded video files and view photo files.

1 Press the Playback recorded media button.

If the 2nd camera is connected, press the  function button and select [Playback] to playback. In each of the screens displayed from here on, the screen automatically returns to the recording screen if you do not perform any operation for approximately 30 seconds.

2 Select the desired folder to view using the / function buttons.

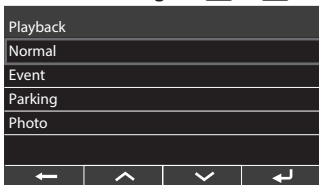

The thumbnails of files in the selected folder will be displayed.

3 Press the / function buttons, select the file, and then press .

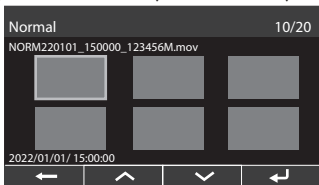

The selected file will play.

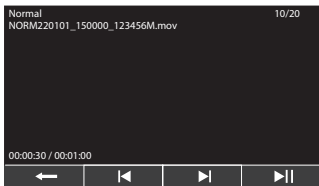

Advanced Driver Assistance Systems (ADAS)

Lane Departure Warning System (LDWS)

This product continues to monitor road conditions. If the product detects Lane Departure, and the vehicle speed $\geq 60\text{km/h}$, then a warning icon is displayed on the screen and a warning sound is played at the same time.

Notes

- Left Lane or Right Lane can be detected, so the left / right icon can be displayed.
- The yellow line is for setting the position when installing the equipment.
- This feature is set to OFF as default. You can activate the feature as below.
→ **“This Product Settings” - “Configurable Features” - “System Setting” - “LDWS”**



Front Collision Warning System (FCWS)

This product continues to monitor road conditions. If the product detects an object, such as a vehicle in front and the distance is 10 meter or less, and the vehicle speed $\geq 60\text{km/h}$, then a warning icon is displayed on the screen and a warning sound is played at the same time.

Note

- This feature is set to OFF as default. You can activate the feature as below
→ **“This Product Settings” - “Configurable Features” - “System Setting” - “FCWS”**



Stop & Go

This product continues to monitor road conditions. If the product detects a vehicle in front at standstill (0km/h) which starts moving, a warning message will be played.

Notes

The feature is set to OFF as default. You can activate the feature as below
→ **“This Product Settings” - “Configurable Feature” - “System Setting” - “Stop & Go”**

If the volume is set to 0, you can not hear the warning message. You can change the volume as below.
→ **“This Product Settings” - “Configurable Feature” - “System Setting” - “Volume”**

⚠ CAUTION

- Usage of the Advanced Driver Assistance Systems (ADAS) features in this product is not a substitute for driver awareness and is not for preventing accidents. The system alerts are to be used as a guidance only.
- It is the user's responsibility in compliance with all applicable laws and ordinance.
- Pioneer is not liable for any damage, due to installation other than described, or use of the product. Pioneer does take responsibility whatsoever for any damage or losses incurred as a result.
- This feature is not linked to the vehicle turn signals, or any other vehicle system.
- It is the user's responsibility to drive whilst keeping a safe distance between vehicles, whilst correctly judging the road, traffic and weather, and surrounding conditions.
- Whether or not the system is functioning correctly, it is the user's responsibility to react to changing road conditions to maintain vehicle control. Failure to do so can result in serious personal injury or death and/or severe property damage.
- Do not operate this product if doing so will divert your attention in any way from the safe operation of your vehicle. Always observe safe driving rules and follow all existing traffic regulations. If you experience difficulty in operating this product or reading the display, park your vehicle in a safe location and apply the handbrake before making the necessary adjustments.

Voice recognition

Some functions can be operated by voice control. You can operate the unit by speaking the specific commands listed as below.

Details	Commands		
	English	French	Russian
A Photo can be taken	Take photo	Prends une photo	Сделать фото
Manual Recording can be started	Video start	Engregistre une vidéo	записать на видеомагнитофон
Audio Recording can be set to ON	Turn on audio	Active le son	Открыть звук озапись
Audio Recording can be set to OFF	Turn off audio	Eteins le son	Закрыть звук озапись
Display can be ON	Turn on screen	Active l'écran	Включить экран
Display can be OFF	Turn off screen	Eteins l'écran	Выключить экран
Front camera image can be shown on the display	Show front camera	Montre la caméra avant	Открыть фронтальную камеру
Rear camera image can be shown on the display (if connected)	Show rear camera	Montre la caméra arrière	Открыть заднюю камеру

English

Language for Voice recognition depends on the "Language Setting".

Language Setting	Voice Recognition
English, Spanish, German, Polish	English
French	French
Russian	Russian

→ "This Product Settings" - "Configurable Feature" - "System Setting" - "Language"

Note

- The feature is set to ON as default. You can deactivate the feature as below.

→ "This Product Settings" - "Configurable Feature" - "System Setting" - "Voice Recognition"

⚠ CAUTION

Recognition accuracy depends on road conditions, distance from the main unit, and speaking style. Pioneer does not guarantee accuracy of voice recognition

This Product Settings

Before using this product, first stop the vehicle in a safe location and apply the handbrake.

These settings configure this product. You can reset the settings to the default settings. You can also format the microSD card and check this product version information.

Note that video recording will stop while the MENU screen is displayed.

1 Press the  function button to open the main menu.

In each of the screens displayed from here on, the screen automatically returns to the recording screen if you do not perform any operation for approximately 30 seconds.

2 Press the  /  function buttons, then select [Video Setting] or [System Setting], and press .

The following describes an example for when [Video Setting] has been selected.

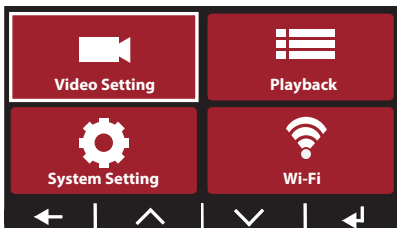

3 Press the  /  function buttons, select the setting item, and then press .

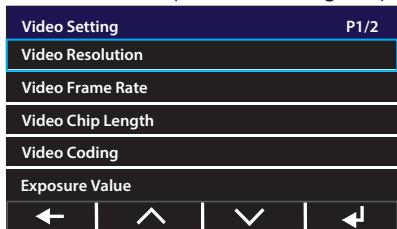

4 Press the  /  function buttons, select the setting value, and then press .

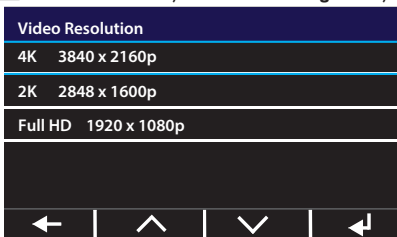

This completes setting, and you are returned to the previous screen.

Configurable Features

Category	Setting	Details	Default Settings
Video Setting	Video Resolution	Sets the resolution quality of video recording. [4K 3840 x 2160p / 2K 2848 x 1600p / Full HD 1920 x 1080p]. The resolution of the 2nd camera is fixed to [Full HD 1920 x 1080 p].	4K 3840 x 2160p
	Video Frame Rate	Sets the frame rate of the video recording. [30 FPS / 27.5 FPS / 25 FPS]	30 FPS
	Video Clip Length	Sets the recording time for one video recording video file, in video recording. [1 min / 3 min / 5 min].	3 min
	Video Coding	Sets the coding of the video recording. [H.265 or H.264]*1	H.265
	Exposure Value	Sets the exposure of video recording. [-2 to +2].	0
	G-Sensor	Sets the sensitivity for detecting vibration or impact. This can also be set: [OFF / High / Mid / Low].	Mid
	Parking Mode (Security Mode)	Sets the sensitivity to record an event, after vibration is detected and the vehicle is parked, and after the power is shut down. This can be set: [OFF/High / Mid / Low].	Mid
System Setting	Language	Sets the language used to display the screen. [English/ Français/Español/Deutsch/Русский/PolSKI].	English
	Monitor Display	Sets the time that the display will go off. [Always ON/ 10 sec / 1 min / 3min / Auto]. When selecting Auto; The Speed over 15 km/h for 5s: display will go OFF. The Speed below 15km/h for 5s: display will go ON. If no GPS: keeps the display status/no change. While Emergency Recording : display will go ON	10 sec
	Microphone	Sets whether or not to record sound around this product during video recording. [ON or OFF].	OFF
	Volume	Sets volume level. [0 to 10].	5
	Voice Recognition	Sets whether or not to activate Voice Recognition . [ON or OFF]	ON
	Speed Unit	Sets the Speed Units. [km/h or mph].	km/h
	LDWS	Sets the LDWS ON/OFF.	OFF
	FCWS	Sets the FCWS ON/OFF.	OFF
	Stop & Go	Sets the Stop & Go ON/OFF	OFF
	Satellite Synchronisation	The Dash Camera time is synchronised by the built-in GPS. [ON or OFF].	ON
	Time Zone Select	Sets the time zone. (When receiving GPS signal, time/date will be automatically set, but not time zone).	GMT+00:00
	Date/Time	Sets the time manually. [Year/Month/day] [Hour/Min/ Sec].	-
	Format SD Card*2	All files on the microSD card can be deleted.	-

Category	Setting	Details	Default Settings
System Setting	Restore Factory Mode	Settings can be reset to the default settings.	-
	OSS License	Allows you to check the OSS license	-
	Download app	Allows you to download the exclusive app "Dash Camera Connect"	-
	Version	Allows you to check the product model number and firmware version information of this product	-
Wi-Fi	Wi-Fi*3	Sets whether or not to enable the product's Wi-Fi to connect to a phone. [ON/OFF]	ON

*1 When selecting H.264, Video Resolution can only be set to Full HD

*2 When there is some problem with the microSD card, a message, such as "No SD Card" is displayed, and recording stops.

*3 Only one smartphone can be paired with the product at one time. In case of iOS, you cannot connect a different iOS device within 2 min after disconnecting a currently paired iOS smartphone. Auto Connection may not be supported for certain smartphones. If it is not supported, please connect your smartphone manually.

Guide to Recording Time and No. of Photos

The following table provides estimates of the video recording times and number of photos possible with different "SD Card Partition" settings. The actual values will depend on various factors, such as the microSD card being used, subject being recorded, and recording conditions.

The "SD Card Partition" is fixed as follows.

As a percentage of memory card capacity, the video recording time will be 59 %, the event recording time will be 10 %, Parking Mode time will be 30 %, and the number of photos will be 1 %.

When Using with Only This Product

Guide to Recording Time and No. of Photos with an 32 GB microSD Card

SD Card Partition	Resolution	Video Recording	Event Recording	Parking Mode Recording	No. of Photos
Normal : 59% Event : 10% Parking : 30% Photo : 1%	2160p (4K)	Approx. 1 hour 42 minutes	Approx. 17 minutes	Approx. 52 minutes	Approx. 400 photos
	1600p (2K)	Approx. 2 hours 5 minutes	Approx. 21 minutes	Approx. 1 hours 4 minutes	Approx. 400 photos
	1080p (FHD H.265)	Approx. 5 hours 44 minutes	Approx. 58 minutes	Approx. 2 hours 55 minutes	Approx. 400 photos
	1080p (FHD H.264)	Approx. 3 hours 4 minutes	Approx. 31 minutes	Approx. 1 hour 33 minutes	Approx. 400 photos

Guide to Recording Time and No. of Photos with an 256 GB microSD Card

SD Card Partition	Resolution	Video Recording	Event Recording	Parking Mode Recording	No. of Photos
Normal : 59% Event : 10% Parking : 30% Photo : 1%	2160p (4K)	Approx. 13 hours 36 minutes	Approx. 2 hours 18 minutes	Approx. 6 hours 55 minutes	Approx. 400 photos
	1600p (2K)	Approx. 16 hours 42 minutes	Approx. 2 hours 50 minutes	Approx. 8 hours 29 minutes	Approx. 400 photos
	1080p (FHD H.265)	Approx. 45 hours 55 minutes	Approx. 7 hours 47 minutes	Approx. 23 hours 21 minutes	Approx. 400 photos
	1080p (FHD H.264)	Approx. 24 hours 30 minutes	Approx. 4 hours 9 minutes	Approx. 12 hours 27 minutes	Approx. 400 photos

When Using with the 2nd Camera (Sold Separately) Connected to This Product

Note

- The estimated recording time differs if the 2nd camera (sold separately) is connected.

Guide to Recording Time and No. of Photos with an 32 GB microSD Card

SD Card Partition	Resolution	Video Recording	Event Recording	Parking Mode Recording	No. of Photos
Normal : 59% Event : 10% Parking : 30% Photo : 1%	2160p (4K)	Approx. 1 hour 21 minutes	Approx. 14 minutes	Approx. 41 minutes	Approx. 800 photos
	1600p (2K)	Approx. 1 hour 35 minutes	Approx. 16 minutes	Approx. 48 minutes	Approx. 800 photos
	1080p (FHD H.265)	Approx. 3 hours 4 minutes	Approx. 31 minutes	Approx. 1 hour 33 minutes	Approx. 800 photos
	1080p (FHD H.264)	Approx. 1 hour 35 minutes	Approx. 16 minutes	Approx. 48 minutes	Approx. 800 photos

Guide to Recording Time and No. of Photos with an 256 GB microSD Card

SD Card Partition	Resolution	Video Recording	Event Recording	Parking Mode Recording	No. of Photos
Normal : 59% Event : 10% Parking : 30% Photo : 1%	2160p (4K)	Approx. 10 hours 48 minutes	Approx. 1 hour 50 minutes	Approx. 5 hours 30 minutes	Approx. 800 photos
	1600p (2K)	Approx. 12 hours 40 minutes	Approx. 2 hours 9 minutes	Approx. 6 hours 27 minutes	Approx. 800 photos
	1080p (FHD H.265)	Approx. 24 hours 30 minutes	Approx. 4 hours 9 minutes	Approx. 12 hours 27 minutes	Approx. 800 photos
	1080p (FHD H.264)	Approx. 12 hours 40 minutes	Approx. 2 hours 9 minutes	Approx. 6 hours 27 minutes	Approx. 800 photos

Exclusive App

The exclusive app "Dash Camera Connect" can be used to check the video recorded on this product or make settings on the screen of an iPhone or smartphone (Android™).

- To use this app, a Wi-Fi connection must be made between this product and iPhone/smartphone (Android™) beforehand.

① Set the Wi-Fi function of this product to on. → **"This Product Settings"**

② Start the exclusive app from your device.

③ Operate the iPhone or smartphone (Android™) to select this product as the Wi-Fi connection device.

The SSID name (access point name) and password of this product can be confirmed and changed on the Wi-Fi setting screen. We recommend that you change the SSID name and password from the default values. However, the SSID name and password will be returned to the default values if you reset the product to the factory default state.

- Only one iPhone/smartphone (Android™) device can be connected to this product at one time. When a second device is connected, the first device will be disconnected.
- While a Wi-Fi connection is made, no operations can be performed on this product.
- It is recommended to enter the search term "Dash Camera Connect" in the search field to search for the application.

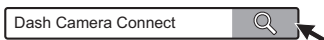

- For how to use the app, check  → [How to use] in the menu at the bottom of the screen of the exclusive app "Dash Camera Connect".

Trademarks & Copyrights

- SD, microSD, microSDHC and microSDXC Logos are trademarks of SD-3C LLC.



- Android is a trademark of Google LLC.
- The Wi-Fi CERTIFIED™ Logo is a registered trademark of Wi-Fi Alliance®



- iPhone is a trademark of Apple Inc., registered in the U.S. and other countries.
- IOS is a trademark or registered trademark of Cisco in the U.S. and other countries and is used under license.
- EU Conformity marking.



- UK Conformity marking.



| GPS

- GPS (Global Positioning System) is a system that measures your current position by receiving position measurement radio signals from GPS satellites.
- The GPS satellite signals cannot pass through solid matter (except glass). The signals from GPS satellites may be blocked when this product is in the following locations.
 - Inside tunnels and parking structures
 - On the bottom level of a two-level highway
 - Around concentrations of skyscrapers
 - In dense forests

Troubleshooting

Symptom	Cause	Action
An error occurred during the display and operation of this product.	The microcomputer in this product is malfunctioning.	Press the reset button. → "Part Names"
	There may be issues with the microSD card.	Format the microSD card. → "This Product Settings" - "Configurable Features" - "System Setting" - "Format SD Card"
A file that should have been saved cannot be found.	If there is insufficient space in the storage areas of the microSD card, the files will be overwritten in order from the oldest files.	We recommend that you back up any important files you want to keep. → "Backing Up Recorded Files"
The product makes parking mode files when you get in and out of the vehicle.	The vibration when people get in and out of the vehicle and the movement of people are being detected.	Adjust the sensitivity of the sensors to use for detection. → "This Product Settings" - "Configurable Features" - "Video Setting" - "Parking Mode" - "G-Sensor"
There are many videos where nothing happens in the files recorded while parked.	The sensitivity of impact detection may not be appropriate.	Adjust the sensitivity of the sensors to use for detection. → "This Product Settings" - "Configurable Features" - "Video Setting" - "G-Sensor"
My vehicle was hit while parked, but a video file wasn't recorded.		
An accident occurred during driving, but a video file wasn't recorded.	The sensitivity of impact detection may not be appropriate.	Adjust the sensitivity of the sensors to use for detection. → "This Product Settings" - "Configurable Features" - "Video Setting" - "G-Sensor"
There's no sound when I play a video file.	The sound recording setting may be OFF.	Check the sound recording setting again. → "This Product Settings" - "Configurable Features" - "System Setting" - "Microphone"
An error message "This SD card is slow. Please format SD Card" occurred periodically.	Fragmented files are generated in the SD card and the SD card is nearing the end of its useful life.	Please replace the SD card.
Screen OFF and Wi-Fi OFF process occurred after high temperature warning screen displayed with beep sound.	The temperature of the main unit LCD is too high and needs to be lowered by limiting product functionalities.	Please wait until the LCD temperature reaches the normal and the product recovers automatically.
The main unit shut down after high temperature warning screen displayed with beep sound.	The temperature of the main unit LCD is too high and the unit needs to be shut down to prevent failure.	Please wait until the LCD temperature reaches the normal and press the power button. → "Part Names"

Specifications

Recording Medium	microSDHC/microSDXC card, Class 10 (32 GB to 256 GB)
Imaging Element	Approx. 8.3 million pixels (Built-in high-sensitivity CMOS sensor)
Recording Angles	Main Unit: 115° horizontal, 60° vertical, 139° diagonal 2nd camera (sold separately): 112° horizontal, 58° vertical, 137° diagonal
F-Number	Main Unit: F1.8 2nd camera (sold separately): F1.9
Recording mode	3840 x 2160P/2848 x 1600P (H.265 only)/1920 x 1080P (H.265 or H.264)
GPS	Built-in
Wi-Fi	<ul style="list-style-type: none">• On-board (for connection of iOS/Android exclusive apps) 802.11b/g/n• Output power: + 19 dBm Max.• Frequency band(s): 2412 MHz to 2472 MHz
G-Sensor	3-axis G-sensor (During event recording: level can be set in 3 steps/during parking mode: level can be set in 3 steps)
Recording Methods	Video recording/event recording/manual event recording/parking mode recording
Video File Structure	1 min/3 min/5 min
Display	3-inch LCD
Sound Recording	Can be set to ON or OFF
Frame Rate	30 fps / 27.5 fps / 25 fps
Compression Method	Video: : MOV (H.265/264), photo: JPG
Video Playback Method	iOS/Android exclusive apps, etc.
Power Supply Voltage	DC 5 V (exclusive power supply included)
Power Consumption	Approx. 4W (Main Unit only) Approx. 6W (Main Unit and 2nd camera)
Operating Temperature	-20 °C to +60 °C
Dimensions (W × H × D)	Main Unit: 93.7 mm × 63 mm × 49.3 mm (width × height × depth) 2nd camera (sold separately): 63.2 mm × 37.1 mm × 31.6 mm (width × height × depth)
Weight	Main Unit: 152 g (excluding bracket, etc.) 2nd camera (sold separately): 35 g
Allowable Installation Angle	16° to 90°

<https://www.pioneer-car.eu/eur/>

Visit www.pioneer-car.eu/uk/ (or www.pioneer-car.eu/eur/) to register your product.

PIONEER CORPORATION

28-8, Honkomagome 2-Chome,
Bunkyo-ku, Tokyo 113-0021
Japan

PIONEER EUROPE NV

Haven 1087, Keetberglaan 1, B-9120 Melsele, Belgium/Belgique
Tel: +32 (0)3 570 05 11

Salamanca, Wellington Street, Slough, SL1 1YP, UK
Tel: +44 (0)208 836 3500