





Enhance Your Driving.

Experience seamless smartphone connectivity on the new SPH-DA97DAB-UNI / SPH-DA97DAB-UNI2 such as Apple CarPlay® and Android Auto™ wirelessly and wired. Enjoy DAB+ Digital Radio and Bluetooth connectivity all via the 9.0" floating display. Due to this 'floating' style the SPH-DA97DAB-UNI and SPH-DA97DAB-UNI2 can be installed into many vehicle types, for example, traditional 1-DIN, 2-DIN. This new flexible design makes the SPH-DA97DAB-UNI and SPH-DA97DAB-UNI2 compatible with almost any vehicle!

Its large stunning 9.0" WSVGA Capacitive touchscreen allows for Pioneer's Split Screen Mode, where you can enjoy Apple CarPlay® and the SPH-DA97DAB-UNI and SPH-DA97DAB-UNI2 shortcut menu at the same time on one screen. Safely operate your music (i.e. Radio, USB,) or other settings whilst looking at your map screen together.

Enjoy superior sound quality, as you would expect from Pioneer. The SPH-DA97DAB-UNI and SPH-DA97DAB-UNI2 features professional sound tuning for high-fidelity sound thanks to its 48-bit dual-core DSP.



Floating Installation To Suit Many Vehicles.

When mounting the SPH-DA97DAB-UNI / SPH-DA97DAB-UNI2, the screen floats on top of the dashboard like a tablet, making it easier to use whilst matching your vehicle interior design.

Floating installation

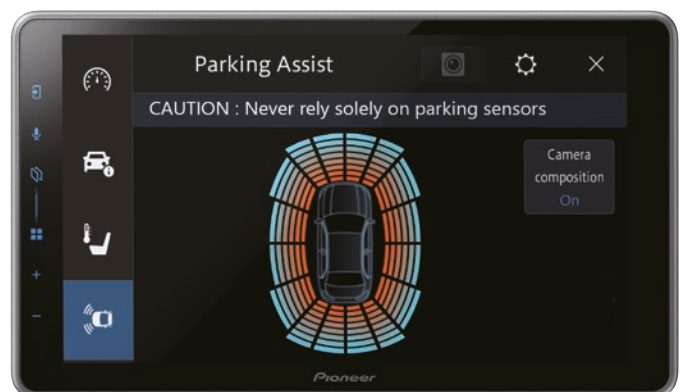

Seamless Connectivity. Stunning Display. Superior Sound.

Key Features

1. Built-In WI-FI®



With built-in Wi-Fi® you can now use Apple CarPlay®, Android Auto™ and Wireless Mirroring. You no longer need a connection cable. Say hello to greater freedom and goodbye to clutter and complication.

2. Apple CarPlay®



Apple CarPlay® is a smarter, safer way to use your iPhone® in the car. It allows you to stay focused on the road and get directions, make calls, send and receive messages and listen to music.

3. Android Auto™



Android Auto™ automatically brings you useful information and organises it into simple cards that appear just when they're needed. It's designed to minimise distraction so you can stay focused on the road ahead.

4. WebLink®



The WebLink® app expands in-car entertainment with an amazing world of apps. Enjoy personalised music, videos, and other connected content powered by your phone/ tablet and the cloud.

5. Pioneer Split Screen Mode



Display Apple CarPlay® and the receiver's menu at the same time on one screen. Useful when you want to operate the music (i.e. Radio or USB) while looking at the map screen.

6. Easy Installation



Combining the physical design of the product and the correct installation kit, this product can be quickly and easily installed into many vehicles!

SPH-EVO107DAB-UNI / SPH-EVO107DAB-UNI2: Elevate your journey.

Features Apple CarPlay® (wireless & wired), Android Auto™ (wireless & wired), DAB+ Digital Radio, Bluetooth®, 2 x camera inputs, Pioneer's Vehicle Bus feature to retain your vehicle information on the Pioneer display, and, a Luminous Bar providing a new entertainment experience through the fusion of sound and light linked to route guidance and your music. In addition to these new features, the SPH-EVO107DAB-UNI / SPH-EVO107DAB-UNI2 keeps Pioneer's ONE SIZE FITS ALL installation possibilities. The ultra large 10.1" HD screen can be installed into multiple different vehicle types thanks to the flexible floating display screen, or you can install the display screen separately from the main body expanding the installation options.



(1) This Wi-Fi CERTIFIED™ Logo is a certification mark of Wi-Fi Alliance® (2) Apple CarPlay® is available on iPhone® 5 or later. For compatibility and availability feature, please visit the official Apple CarPlay® website at apple.com/ios/carplay. (3) Availability of Android Auto may vary depending on your country or phone model. Please visit android.com/auto for more information.

Display Audio Navigation, Music, DAB+



SPH-DA77DAB

ALL IN ONE

Compliment your lifestyle by bringing your favourite smartphone apps with you. Products with a wireless connection offer an even more connected and convenient

use of Apple CarPlay® and Android Auto™.

Enjoy your apps on a big screen and experience them via voice-control. Enjoy a truly connected experience.

Key Features

1. Built-In Wi-Fi®

Experience Apple CarPlay® or Android Auto™ via a wireless connection. The best means of operating a smartphone is wirelessly, for greater freedom from clutter and complication.

2. Apple CarPlay®

Apple CarPlay® is a smarter, safer way to use your iPhone® in the car that allows you to stay focused on the road and get directions, make calls, send and receive messages, and listen to music. Just connect your iPhone® and go.

3. Android Auto™

Android Auto™ automatically brings you useful information and organises it into simple cards that appear just when they're needed. It's designed to minimise distraction so you can stay focused on the road ahead.

4. Large Capacitive Type Display

Pioneer's large Capacitive Type Displays give you a dynamic new visual experience and makes the operation much easier. All Pioneer displays are highly responsive enabling smoother, easier and safer operation whilst driving.

5. DAB/DAB+ Digital Radio and Bluetooth®













Enjoy the convenience of listening to your favourite radio stations in crystal clear digital quality thanks to a built-in DAB+ Digital Radio tuner. Built-in Bluetooth wireless connectivity provides convenient hands-free calling and music streaming with compatible Bluetooth enabled devices. Users can experience hands-free calling and/or music to be streamed.

6. Easy Installation

The NEW Pioneer SPH-DA77DAB screen itself is a traditional 2-DIN, but with a new 1-DIN short chassis design combined making it even easier to install into many more vehicles! Now you can quickly and easily fit all the cables behind the dashboard saving you installation time.

and more...



	Installation Type	Navigation	Screen	Apple CarPlay®	Android Auto™	WebLink®	Bluetooth®	DAB+ Digital Radio	CD/DVD	Accessories (Sold Separately)
 NEW SPH-EV0107DAB-UNI SPH-EV0107DAB-UNI2	Floating / Modular 1-DIN Floating / Modular 2-DIN	Via Apple CarPlay® Via Android Auto™	10.1" HD Capacitive	Wireless / Wired	Wireless / Wired	Wired	✓	✓	✗	ND-BC9 / CA-AN-DAB.001
 SPH-EV0950DAB-UNI SPH-EV0950DAB-UNI2	Floating / Modular 1-DIN Floating / Modular 2-DIN	Via Apple CarPlay® Via Android Auto™	9" WSVGA Capacitive	Wireless / Wired	Wireless / Wired	Wired	✓	✓	✗	SDA-HU100 / ND-BC9 / CA-AN-DAB.001
 AVH-Z9200DAB	Standard 2-DIN	Via Apple CarPlay® Via Android Auto™	7" WVGA Clear Type Resistive	Wireless / Wired	Wireless / Wired	Wired	✓	✓	✓	ND-BC9 / CA-AN-DAB.001
 AVH-Z7200DAB	Standard 1-DIN	Via Apple CarPlay® Via Android Auto™	7" WVGA Clear Type Resistive (Motorised Flip-out)	Wired	Wired	Wired	✓	✓	✓	ND-BC9 / CA-AN-DAB.001
 AVH-Z5200DAB	Standard 2-DIN	Via Apple CarPlay® Via Android Auto™	6.8" WVGA Clear Type Resistive	Wired	Wired	Wired	✓	✓	✓	ND-BC9 / CA-AN-DAB.001
 NEW SPH-DA97DAB-UNI SPH-DA97DAB-UNI2	Floating 1-DIN Floating 2-DIN	Via Apple CarPlay® Via Android Auto™	9" WSVGA Capacitive	Wireless / Wired	Wireless / Wired	Wired	✓	✓	✗	ND-BC9 / CA-AN-DAB.001
 NEW SPH-DA77DAB	Standard 2-DIN with 1-DIN short chassis	Via Apple CarPlay® Via Android Auto™	6.8" WSVGA Capacitive	Wireless / Wired	Wireless / Wired	Wired	✓	✓	✗	ND-BC9 / CA-AN-DAB.001
 SPH-DA360DAB	Standard 2-DIN	Via Apple CarPlay® Via Android Auto™	6.8" WVGA Capacitive	Wireless / Wired	Wireless / Wired	Wired	✓	✓	✗	ND-BC9 / CA-AN-DAB.001
 SPH-DA160DAB	Standard 2-DIN	Via Apple CarPlay® Via Android Auto™	6.8" WVGA Capacitive	Wired	Wired	Wired	✓	✓	✗	ND-BC9 / CA-AN-DAB.001
 AVH-A240DAB	Standard 2-DIN	Via WebLink®	6.2" WVGA Clear Type Resistive	✗	✗	Wired	✓	✓	✓	ND-BC9 / CA-AN-DAB.001
 DMH-A340DAB	Standard 2-DIN	Via WebLink®	6.8" WVGA Capacitive	✗	✗	Wired	✓	✓	✗	ND-BC9 / CA-AN-DAB.001
 DMH-A240DAB	Standard 2-DIN	Via WebLink®	6.2" WVGA Clear Type Resistive	✗	✗	Wired	✓	✓	✗	ND-BC9 / CA-AN-DAB.001
 DMH-A240BT	Standard 2-DIN	Via WebLink®	6.2" WVGA Clear Type Resistive	✗	✗	Wired	✓	✗	✗	ND-BC9



For illustrative purposes only.

Two way Mirroring for iPhone & Android

The WebLink® app turns your vehicle into a connected car by letting you easily enjoy your favorite apps on the go. Once you've downloaded the app, simply use your smartphone to connect to your car's WebLink®-compatible Pioneer receiver, and then launch popular navigation, media, weather, and even calendar apps.



Scan the QR Code to discover more!





Ready To Connect!

Pioneer's DCT-WR204-SH Wi-Fi® Router is a package consisting of a discreet hide-away Wi-Fi® router combined with a small, lightweight, IP66 rated, external roof mounted MiMo sharkfin antenna. This creates a perfect package for good stable Wi-Fi® inside or outside your motorhome / campervan, even in remote areas.

This easy-to-install external roof mounted MiMo sharkfin antenna can even be installed on wave-shaped roofs. In addition, there is two built-in internal Wi-Fi® antennas in the DCT-WR204-SH Wi-Fi® Router itself offering you wide coverage.

Featuring a unique Wi-Fi® repeater function with Dual Band Wi-Fi® 2.4GHz or 5GHz frequencies, you can now maintain good internet speeds for up to 32 simultaneously connected devices!

Pioneer's DCT-WR204-SH Wi-Fi® Router really is the perfect motorhome / campervan accessory to stay connected.



Scan the QR Code
to discover more!







Car Audio with Pioneer Smart Sync App









Pioneer Smart Sync app is the one-stop solution for getting the most out of your smartphone. Enjoy the freedom of smart functions, lifting your driving experience to a new level. Personalise the app easily for a more enjoyable drive, switching between Driver Pilot Mode or Personal Photo Mode in a click. You can also listen to your favourite artists in true Pioneer sound quality, navigate to your destination with Voice Control (Alexa) and so much more. You will get to enjoy driving as you've never experienced it.



Car Audio with DAB+

		Built-in Smartphone Cradle	CD Player	Preouts	Colour Customisation	Equaliser	Time Alignment	Screen	
	SPH-20DAB	✓	✗	2	✓	13 Band (31 Band via PSS app)	Manual (via PSS App)	LCD 1 Line text	
	MVH-S520DAB	✗	✗	3	✓	13 Band / N	Manual (via PSS App)	LCD 2 Line text	
	MVH-S420DAB	✗	✗	2	✗	13 Band	Manual	LCD 2 Line text	
	DEH-S720DAB	✗	✓	3	✓	13 Band / N	Manual	LCD 2 Line text	
	FH-S820DAB	✗	✓	3	✓	13 Band / N	Manual	LCD 2 Line text	

Car Audio Regular

		Pioneer Smart Sync	Built-in Smartphone Cradle	CD Player	Preouts	Short Chassis	MIXTRAX	Colour Customisation	Equaliser	Time Alignment	Direct Control for iPod/iPhone®
	SPH-10BT	✓	✓	✗	2	✗	✗	✓	13 Band (31 Band via PSS app)	Manual	iPhone only
	MVH-S520BT	✓	✗	✗	3	✗	✗	✓	13 Band	Manual	iPhone only
	MVH-S420BT	✓	✗	✗	2	✓	✗	✗	13 Band	Manual	iPhone only
	MVH-S320BT	Android only	✗	✗	2	✓	✗	✗	13 Band	Manual	✗
	DEH-S520BT	✓	✗	✓	3	✗	✓	✓	13 Band	Manual	iPhone only
	DEH-S420BT	✓	✗	✓	2	✗	✗	✗	13 Band	✗	iPhone only
	DEH-S320BT	Android only	✗	✓	2	✗	✗	✗	13 Band	✗	✗
	FH-S720BT	✓	✗	✓	3	✗	✗	✓	13 Band / N	Manual	iPhone only

As Pioneer Car Audio technology is constantly evolving, we regularly update the Pioneer Smart Sync app with new features. Be the first to know about the latest product information, firmware updates and other topics by registering to **My Account** on www.pioneer-car.eu/eur/user/register.





Upgrade your sound, with Pioneer Car Speakers

Pioneer is devoted to developing automotive loudspeakers using the most advanced computer modelling, real world measurements and most importantly, our own ears. Reproducing music in its purest form and allowing the listener to experience the music as the artist intended. That's the true sound of Pioneer.

Z Series

No Compromise. High Resolution Sound. The Z Series is based on highly advanced technology, employing carefully selected materials and parts, benefiting from our decades of automotive loudspeaker design theory and testing ability.



TS-Z65CH, TS-Z10LS4/S2 and more
(see overview on page 20)



TS-Z65CH



TS-Z10LS4/S2



D Series

Bold Sound & Wide Coverage. Following Pioneer's OPEN & SMOOTH™ sound concept, the D Series of high performance speakers provide broad and balanced frequency response with a wide sound stage and ambience.



TS-D65C, TS-D10LS4/S2 and more
(see overview on page 19)



TS-D65C



TS-D10LS4/S2

Experience the music...



A Series

The Perfect OEM Sound Upgrade System. Designed to be the perfect OEM sound upgrade system, the A Series speakers deliver Pioneer's famous OPEN & SMOOTH™ sound concept, all in an easy to install package whilst being able to deliver 'Richer Bass and Well Controlled Sound'.



For illustrative purposes only.

TS-A300B, TS-A1671F, TS-A6991F, TS-A301TW and more (page 21)

R Series

Strong, Loud & Aggressive. Designed to generate its loud and controlled sound quality from a multilayer mica matrix woofer cone which ensures punching bass and improved midrange frequency response.



TS-R1750S and more (page 22)

G Series

The Perfect Replacement Offering A Well Balanced Sound. Offers wide, easy install ability and excellent value for money. These speakers reproduce deep, impactful bass and natural highs – even when connected to your original stereo system.



For illustrative purposes only.

TS-G6930F, TS-G170C and more (page 22)

Custom-Fit Series

Easily Upgrade For Higher Quality Sound. Features a high performance IMPP (Injection-Moulded Polypropylene) cone for rich bass sounds and come with a unique connector – there is no need for additional adapters or modifications.



TS-170CI and more (see www.pioneer-car.eu)

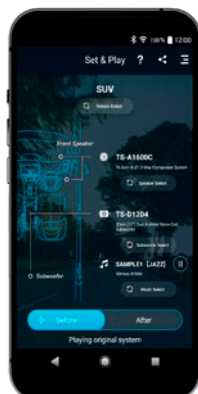

PIONEER CARSOUNDFIT APP

Pioneer's CarSoundFit application simulates the sound quality difference when original pre-fitted speakers would be replaced by Pioneer speakers in your vehicle.

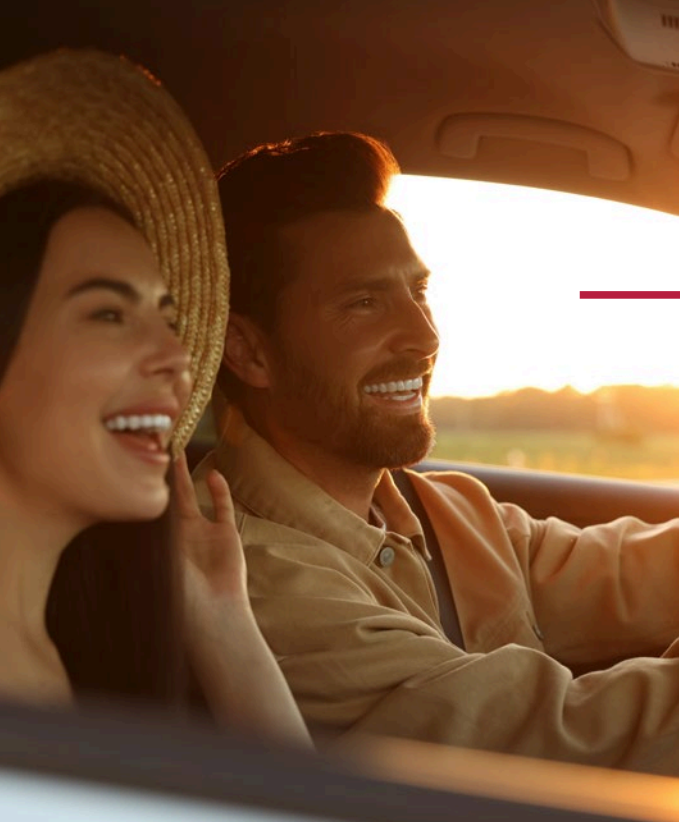

Because your music needs a strong foundation

ACTIVE POWERED SUBWOOFER

Pioneer's active powered subwoofers are designed to be installed in the passenger foot space area or the boot. No matter its size, it's always powerful and space saving.

Key Features

- 1. Built-in amplifier** simplifies installation, especially in tight space.
- 2. Pre-loaded subwoofer** with Class-D amplifier provides high-quality bass sound via remote control.
- 3. High-efficiency, high-quality** Class-D amplifier with bass boost circuit reproduces rich bass sound even at low volume.
- 4. Space-saving designs**, mesh grill protection and a classy look make these units a great match for various vehicle types.



TS-WX140DA



TS-WX1010LA



TS-WX400DA



TS-WX70DA

TS-WX010A: Pioneer's Award Winning Ultra Compact Space Saving Active Subwoofer.

The perfect solution to add deep and powerful bass in your Electric Vehicle (EV), without sacrificing space.

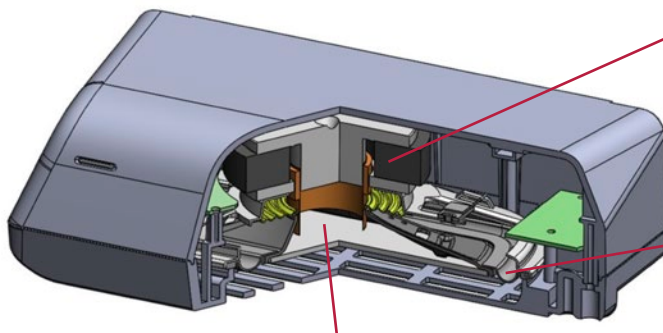

A high power magnetic circuit.

High power drives the woofer cone with force.

- Uses a large magnetic circuit, creating a high driving force for maximum subwoofer cone movement.
- Balanced with a large magnet, optimised thickness and shape of internal components, we developed a strong force to drive the voice coil creating a balance of performance and power.

Urethane Surround.

Controlled motion, with flexibility and accurate control.

- A carefully developed Urethane surround, is light in weight, thick, and durable, to keep a strong controlled motion under heavy load in this small enclosure.

Aluminium Diaphragm.

Accurate motion for high quality sound.

- Using an aluminium diaphragm is effective for big subwoofer excursion in small enclosures.
- By selecting "Aluminium" we can deliver good bass sound with clean cone movement at high pressure.



Subwoofers

OVERVIEW WITH KEY SPECIFICATIONS

	Size (cm) (W x D x H)	Type	DIGITAL BASS CONTROL	Class-D	Maximum Power	Nominal Power	Frequency Response	Sensitivity	Impedance	Mounting depth	Cut-Out Dimensions ø	Recommended Enclosure (ft ³ / litre)	Wired Remote Control Included
 GXT-3730B-SET	355 (W) x 350 (H) x 368 (D) mm	Sub & Amp Package (cables included)	✗	✗	1400 W	400 W	22 Hz - 1.6 kHz	87 dB	4 Ω	✗	✗	✗	✗
 TS-WX306B	508 (W) x 379 (H) x 328 (D) mm	Sealed	✗	✗	1300 W	350 W	20 - 125 Hz	94 dB	4 Ω	✗	✗	✗	✗
 TS-WX306T	335 (Dia) x 640 (W)	Bass Reflex Tube Type	✗	✗	1300 W	350 W	20 - 125 Hz	96 dB	4 Ω	✗	✗	✗	✗
 TS-WX300A	503 (W) x 378 (H) x 318 (D) mm	Active	✗	✓	1300 W	350 W	20 - 130 Hz	113 dB	✗	✗	✗	✗	✗
 TS-WX70DA	85 x 32 x 9 cm	Active / Ultra-Flat	✓	✓	200 W	100 W	Deep: 20 - 250 Hz Dynamic: 40 - 250 Hz	Deep: 104 dB Dynamic: 110 dB	✗	✗	✗	✗	✓
 TS-WX400DA	30 x 20 x 10 cm	Active / Under seat	✓	✓	250 W	100 W	Deep: 20 - 100 Hz Dynamic: 40 - 100 Hz	Deep: 100 dB Dynamic: 100 dB	✗	✗	✗	✗	✓
 TS-WH500A	34 x 25 x 6 cm	Active / HVT Sealed	✗	✗	150 W	50 W	20 - 200 Hz	98 dB	✗	✗	✗	✗	✓
 TS-WX1220AH	74.5 x 44.3 x 40 cm	Active / Dual 12" Slot Port	✗	✓	3000 W	1000 W	20 Hz ~ 2.9 kHz	118 dB	✗	✗	✗	✗	✓
 TS-WX1210AH	37.3 x 44.3 x 40 cm	Active / Single 12" Slot Port	✗	✓	1500 W	500 W	20 Hz ~ 2.9 kHz	114 dB	✗	✗	✗	✗	✓
 TS-WX1010LA	53 x 11.8 x 30 cm (Top Surface 15 cm)	Active / 10" Shallow Sealed	✗	✓	1200 W	300 W	21 Hz ~ 3.4 kHz	111 dB	✗	✗	✗	✗	✓
 TS-WX010A	230 x 116 x 70 mm	Active / Footspace	✗	✓	160 W	50 W	20 Hz - 200 Hz	98 dB	✗	✗	✗	✗	✗
 TS-WX140DA	280 x 200 x 70 mm	Active / Under seat	✓	✓	170 W	50 W	Deep: 20 - 200 Hz Dynamic: 40 - 160 Hz Natural: 40 - 200 Hz	Deep: 95 dB Dynamic: 100 dB Natural: 98 dB	✗	✗	✗	✗	✓
 TS-WX130EA	28 x 20 x 7 cm	Active / Under seat	✗	✓	160 W	50 W	40 - 200 Hz	98 dB	✗	✗	✗	✗	✗

Scan the QR Code
to discover more!





High Quality Amplifiers

Pioneer is renowned for high quality durable amplifiers. All of these features result in an improved sound experience in your car, even when connected to your original car audio system.



Hi-Res
AUDIO

GM-DX874

GM-D1004

For illustrative purposes only.

Key Features

1. High Resolution Sound
2. Easy To Install
3. Compact size
4. Class D Technology
5. Speaker Line Input Sensor



GM-D8704

4-Channel 1200W
Class-FD Car
Amplifier

1,200 W MAX.





DEQ-S1000A2

Designed to upgrade the sound of your original factory car stereo and speakers. Connects to Apple iOS & Android devices, and utilises Pioneer's Sound Tune app, for set up and high quality audio features.



Add power to your sound

		Number of Channels	Class D	Maximum power	Continuous Power	Frequency Response	Distortion	S/N Ratio	Dimensions (W x H x D)
	GM-DX874	4/3/2	✓	200 W x 4 (4 Ω) 300 W x 4 (2 Ω) 1200 W Total	100 W x 4 (4 Ω) 150 W x 4 (2 Ω) 125 W x 4 (1 Ω) 300 W x 2 (4 Ω bridged)	10 Hz - 50 kHz	< 0.05 %	> 95 dB	252 x 60 x 215 mm
	GM-D9704	4/3/2	✓	260 W x 4 (4 Ω) 400 W x 4 (2 Ω) 1600 W Total	130 W x 4 (4 Ω) 200 W x 4 (2 Ω) 130 W x 4 (1 Ω) 400 W x 2 (4 Ω bridged)	10 Hz - 50 kHz	< 0.05 %	> 95 dB	302 x 60 x 215 mm
	GM-D9701	1	✓	1000 W x 4 (4 Ω) 1600 W x 4 (2 Ω) 2400 W Total	500 W x 1 (4 Ω) 800 W x 1 (2 Ω) 1200 W Total	10 Hz - 240 kHz	< 0.05 %	> 100 dB	302 x 60 x 215 mm
	GM-D8704	4/3/2	✓	200 W x 4 (4 Ω) 300 W x 4 (2 Ω) 1200 W Total	100 W x 4 (4 Ω) 150 W x 4 (2 Ω) 125 W x 4 (1 Ω) 300 W x 2 (4 Ω bridged)	10 Hz - 50 kHz	< 0.05 %	> 95 dB	252 x 60 x 215 mm
	GM-D8701	1	✓	600 W x 1 (4 Ω) 1000 W x 1 (2 Ω) 1600 W Total	300 W x 1 (4 Ω) 500 W x 1 (2 Ω) 800 W Total	10 Hz - 240 kHz	< 0.05 %	> 100 dB	252 x 60 x 215 mm
	GM-D1004	4	✓	100 W x 4 (4 Ω) 100 W x 4 (2 Ω)	45 W x 4 (4 Ω) 45 W x 4 (2 Ω)	10 Hz - 40 kHz	< 0.05 %	> 90 dB	181 x 38 x 64 mm
	GM-A6704	4/3/2	✗	170 W x 4 (4 Ω) 250 W x 4 (2 Ω) 500 W x 2 (4 Ω bridged)	60 W x 4 (4 Ω) 95 W x 4 (2 Ω) 190 W x 2 (4 Ω bridged)	10 Hz - 70 kHz	< 0.05 %	> 95 dB	356 x 60 x 215 mm
	GM-A4704	4/3/2	✗	80 W x 4 (4 Ω) 130 W x 4 (2 Ω) 260 W x 2 (4 Ω bridged)	40 W x 4 (4 Ω) 65 W x 4 (2 Ω) 130 W x 2 (4 Ω bridged)	10 Hz - 70 kHz	< 0.05 %	> 94 dB	326 x 60 x 215 mm
	GM-A5702	2/1	✗	300 W x 2 (4 Ω) 500 W x 2 (2 Ω) 1000 W x 1 (4 Ω bridged)	150 W x 2 (4 Ω) 240 W x 2 (2 Ω) 480 W x 1 (4 Ω bridged)	10 Hz - 70 kHz	< 0.05 %	> 96 dB	356 x 60 x 215 mm
	GM-A3702	2/1	✗	170 W x 2 (4 Ω) 250 W x 2 (2 Ω) 500 W x 1 (4 Ω bridged)	60 W x 2 (4 Ω) 95 W x 2 (2 Ω) 190 W x 1 (4 Ω bridged)	10 Hz - 70 kHz	< 0.05 %	> 95 dB	246 x 60 x 180 mm



GXT-3730B-SET

Subwoofer and amplifier package, including 30 cm subwoofer in sealed enclosure, 2-channel bridgeable amplifier and connecting cables.

Scan the QR Code to discover more!





A Pioneer Dash Camera

Pioneer Dash Cameras are designed to protect you and your loved ones. They capture every movement in high quality, giving you piece of mind when driving or even when parked. Our Dash Cameras are designed to protect you from insurance fraud, in case of an accident. With high quality recordings, you can easily prove responsibility. Find a Dash Camera for your need and hit the road safely!

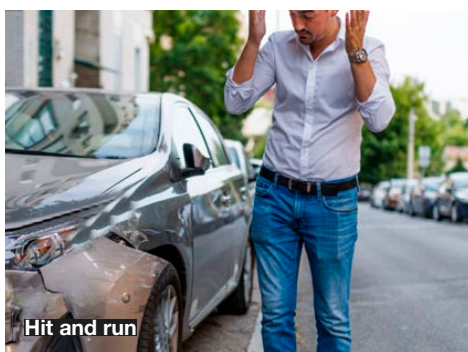

Key Features

1. High Quality 4K & Full HD Recording

The better the quality of the video recording, the more reliable the evidence. That is why Pioneer's entire Dash Camera range can capture detailed images in FULL HD (1920 x 1080). Thanks to the high quality of the recordings they can be used as evidence in case of an incident.

2. Wide Viewing Angle

A moving object can come from any direction. Enjoy panoramic video content and imagery thanks to our Wide Viewing Angle, capturing every event around your vehicle.



3. 24/7 Security Mode

Monitor your vehicle 24 hours a day, 365 days a year, using your vehicles battery. When your vehicle is parked, as soon as movement is detected caused by an impact, the Dash Camera will automatically trigger a video recording.

4. Night Time Mode

Reliable, high-sensitivity and high-quality video recording at night. When driving on roads, in tunnels or at night, you can clearly record your vehicle and surrounding conditions. By using a Sony's CMOS sensor with STARVIS™ technology, our Dash Cameras are suitable for night time recording.

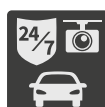

Optional Rear camera

On selected models Pioneer offers an optional rear facing camera, ND-RC1. The optional camera not only enables dual channel recording but also Tailgating Warning. By using a Sony's CMOS sensor with STARVIS technology, the camera also allows perfect recording at night.

Your extra eye on the road!

	Camera Type	Screen Size	Resolution	Viewing Angle	24/7 Security Mode	Night Time Mode	Sensor	Smartphone App	Voice Guidance / Voice Recognition	ADAS (Advanced Driver Assistance Systems)	Rear View Mirror Type	Accessories (Sold Separately)	
	VREC-Z810SH (Optional Rear)	1-Channel (Optional Rear)	3" LCD	4K	Front: 139°	✓ ⁽¹⁾	✓	Sony's CMOS sensor with STARVIS™ technology	Pioneer "Dash Camera Connect" app	✓	Stop & Go FCWS ⁽²⁾ / LDWS ⁽³⁾	✗	ND-RC1
	VREC-Z710SH (Optional Rear)	1-Channel (Optional Rear)	2" LCD	Full HD	Front: 160°	✓ ⁽¹⁾	✓	Sony's CMOS sensor with STARVIS™ technology	Pioneer "Dash Camera Interface" app	✗	Tailgating Warning	✗	ND-RC1 / AD-PLF100
	VREC-H310SH (Optional Rear)	1-Channel (Optional Rear)	3" LCD	Full HD	Front: 139°	✓ ⁽¹⁾	✓	Sony's CMOS sensor with STARVIS™ technology	Pioneer "Dash Camera Connect" app	✗	FCWS ⁽²⁾ / LDWS ⁽³⁾	✗	ND-RC1
	VREC-150MD	2-Channel	6.7" LCD Touchscreen	Full HD	Front: 150° Rear: 120°	✗	✗	CMOS sensor	✗	✗	✗	✓	✗

VREC-150MD is not available in all countries.

(1) Wiring kit included in the box. (2) Front Collision Warning System (FCWS). (3) Lane Departure Warning System (LDWS).

VREC-Z810SH



VREC-Z710SH



VREC-H310SH



VREC-150MD

VREC-150MD is not available in all countries.



Display Audio

OVERVIEW WITH KEY SPECIFICATIONS

Navigation

	Installation type	Navigation	Screen	Apple Carplay®	Android Auto™	Wired Mirroring	Bluetooth	DAB+ Digital Radio	USB	CD / DVD player	
	AVIC-Z1000DAB	Standard 2-DIN	Built-in	9" WVGA Capacitive	Wireless / Wired	Wireless / Wired	WebLink® 1.0	✓	✓	2	✗
	AVIC-Z930DAB	Standard 2-DIN	Built-in	7" WVGA Capacitive (Motorised)	Wireless / Wired	Wireless / Wired	WebLink® 1.0	✓	✓	2	✓
	AVIC-Z830DAB	Standard 2-DIN	Built-in	7" WVGA Clear Type Resisitive (Motorised)	Wireless / Wired	Wireless / Wired	WebLink® 1.0	✓	✓	2	✓
	AVIC-Z730DAB	Standard 2-DIN	Built-in	6.2" WVGA Clear Type Resisitive	Wireless / Wired	✗	WebLink® 1.0	✓	✓	2	✓
	AVIC-Z630BT	Standard 2-DIN	Built-in	6.2" WVGA Clear Type Resisitive	Wireless / Wired	✗	WebLink® 1.0	✓	✗	2	✓

Car specific











	SPH-EV0107DAB-UNI SPH-EV0107DAB-UNI2	Floating / Modular 1-DIN Floating / Modular 2-DIN	Via Apple CarPlay® Via Android Auto™	10.1" HD Capacitive	Wireless / Wired	Wireless / Wired	WebLink® 3.0 Wired	✓	✓	1	✗
	SPH-EV0950DAB-UNI SPH-EV0950DAB-UNI2	Floating / Modular 1-DIN Floating / Modular 2-DIN	Via Apple CarPlay® Via Android Auto™	9" WSVGA Capacitive	Wireless / Wired	Wireless / Wired	Wired	✓	✓	1	✗
	SPH-DA97DAB-UNI SPH-DA97DAB-UNI2	Floating 1-DIN Floating 2-DIN	Via Apple CarPlay® Via Android Auto™	9" WSVGA Capacitive	Wireless / Wired	Wireless / Wired	WebLink® 3.0 Wired	✓	✓	1	✗
	SPH-EV093DAB	Modular and 1-DIN	Via Apple CarPlay® Via Android Auto™	9" HD (1280x720) Capacitive	Wireless / Wired	Wireless / Wired	✗	✓	✓	1	✗
	SPH-EV082DAB	Modular and 1-DIN	Via Apple CarPlay® Via Android Auto™	8" WVGA Capacitive	Wired	Wired	WebLink® 1.0	✓	✓	1	✗
	SPH-EV064DAB	Modular, 1-DIN and 2 DIN	Via Apple CarPlay® Via Android Auto™	6.8" WVGA Capacitive	Wireless / Wired	Wireless / Wired	✗	✓	✓	1	✗
	SPH-EV062DAB	Modular, 1-DIN and 2 DIN	Via Apple CarPlay® Via Android Auto™	6.8" WVGA Clear Type Resisitive	Wired	Wired	WebLink® 1.0	✓	✓	1	✗



SPH-DA77DAB
New Display Audio



Multimedia

	Installation type	Navigation	Screen	Apple Carplay	Android Auto	Wired Mirroring	Bluetooth	DAB+ Digital Radio	USB	CD / DVD player
 NEW	Standard 2-DIN with 1-DIN short chassis	Via Apple CarPlay® Via Android Auto™	6.8" WSVGA Capacitive	Wireless / Wired	Wireless / Wired	WebLink® 3.0	✓	✓	1	✗
	Standard 2-DIN	Via Apple CarPlay® Via Android Auto™	6.8" WVGA Capacitive	Wireless / Wired	Wireless / Wired	WebLink® Cast	✓	✓	1	✗
	Standard 2-DIN	Via Apple CarPlay® Via Android Auto™	6.8" WVGA Capacitive	Wired	Wired	WebLink® 1.0	✓	✓	1	✗
	Standard 2-DIN	Via Apple CarPlay® Via Android Auto™	6.8" WVGA Capacitive	Wired	Wired	USB Mirroring for Android	✓	✓	1	✗
	Standard 2-DIN	Via Apple CarPlay® Via Android Auto™	7" WVGA Clear Type Resistive	Wireless / Wired	Wireless / Wired	WebLink® 1.0	✓	✓	2	✓
	Standard 1-DIN	Via Apple CarPlay® Via Android Auto™	7" WVGA Clear Type Resistive Flip-out	Wired	Wired	WebLink® 1.0	✓	✓	1	✓
	Standard 2-DIN	Via Apple CarPlay® Via Android Auto™	6.8" WVGA Clear Type Resistive	Wired	Wired	WebLink® 1.0	✓	✓	1	✓
	Standard 2-DIN	Via Apple CarPlay®	6.2" WVGA Clear Type Resistive	Wired	✗	WebLink® 1.0	✓	✓	1	✓
	Standard 2-DIN	Via Apple CarPlay® Via Android Auto™	6.2" WVGA Clear Type Resistive	✗	✗	WebLink® 1.0	✓	✓	1	✓
	Standard 2-DIN	✗	6.2" WVGA Clear Type Resistive	✗	✗	WebLink® 1.0	✓	✓	1	✗

WebLink® Cast

	Modular 2-DIN	Via WebLink®	9" WSVGA Capacitive	✗	✗	Wired	✓	✗	✓	✗
	Standard 2-DIN	Via Wired Mirroring	6.8" WVGA Capacitive	✗	✗	WebLink® Cast	✓	✓	1	✗
	Standard 2-DIN	Via Wired Mirroring	6.2" WVGA Clear Type Resistive	✗	✗	WebLink® Cast	✓	✓	1	✗
	Standard 2-DIN	Via Wired Mirroring	6.2" WVGA Clear Type Resistive	✗	✗	WebLink® Cast	✓	✗	1	✗
	Standard 2-DIN	Via Wired Mirroring	6.2" WVGA Clear Type Resistive	✗	✗	WebLink® Cast	✓	✓	1	✓
	Standard 2-DIN	Via Wired Mirroring	6.2" WVGA Clear Type Resistive	✗	✗	WebLink® Cast	✓	✗	1	✓

Display Audio

Car Audio

Speakers

Subwoofers











Amplifiers

Dash Camera

Product overview

Car Audio

OVERVIEW WITH KEY SPECIFICATIONS

Car Audio with DAB+	DAB+ Digital Radio	Pioneer Smart Sync	Built-in Smartphone Cradle	Bluetooth	CD Player	USB	Pre-outs	Short Chassis	Quick Charge for Android	Colour Customisation	Equaliser	MOSFET 50 W x 4 Power	Time Alignment	I/R Remote Control compatible	Audio compatibility	Direct Control for iPod/iPhone®	Screen
 SPH-20DAB	✓	✓	✓	✓	✗	1	2	✗	✓	✓	13 Band (31 Band via PSS app)	✓	Manual (via PSS App)	✗	MP3/WMA/WAV/AAC/FLAC	iPhone® only	LCD 1 Line text
 MVH-S520DAB	✓	✓	✗	✓	✗	1	3	✗	✓	✓	13 Band / N	✓	Manual (via PSS App)	✗	WMA/MP3/WAV/AAC/FLAC	iPhone® only	LCD 2 Line text
 MVH-S420DAB	✓	✓	✗	✓	✗	1	2	✗	✓	✗	13 Band	✓	Manual	✗	WMA/MP3/WAV/AAC/FLAC	iPhone® only	LCD 2 Line text
 MVH-330DAB	✓	✗	✗	✓	✗	1	1	✓	✗	✗	2 Band	✓	✗	✗	MP3/WMA/WAV/FLAC	✗	LCD 1 Line text
 MVH-S220DAB	✓	✗	✗	✗	✗	1	2	✗	✗	✗	5 Band	✓	✗	✗	MP3/WMA/WAV/AAC	iPhone® only	LCD 1 Line text
 MVH-130DAB	✓	✗	✗	✗	✗	1	1	✓	✗	✗	2 Band	✓	✗	✗	MP3/WMA/WAV/FLAC	✗	LCD 1 Line text
 FH-S820DAB	✓	✓	✗	✓	✓	1	3	✗	✓	✓	13 Band / N	✓	Manual	✗	WMA/MP3/WAV/AAC/FLAC	iPhone® only	LCD 2 Line text
 DEH-X8700DAB	✓	✗	✗	✓	✓	1	3(4V)	✗	✗	✓	5 Band	✓	✗	✓	MP3/WMA/WAV/AAC/FLAC	✓	LCD 2 Line text
 DEH-S720DAB	✓	✓	✗	✓	✓	1	3	✗	✓	✓	13 Band / N	✓	Manual	✗	MP3/WMA/WAV/AAC/FLAC	iPhone® only	LCD 2 Line text
 DEH-S410DAB	✓	✗	✗	✗	✓	1	2	✗	✗	✓	5 Band	✓	✗	✗	MP3/WMA/WAV/AAC	✓	LCD 1 Line text
 DEH-X7800DAB	✓	✗	✗	✓	✓	1	2	✗	✗	✓	13 Band	✓	Manual	✗	MP3/WMA/WAV/AAC/FLAC	✓	LCD 1 Line text



MVH-S320BT



Car Audio

	DAB+ Digital Radio	Pioneer Smart Sync	Built-in Smartphone Cradle	Bluetooth	CD Player	USB	Pre-outs	Short Chassis	Quick Charge for Android	Colour Customisation	Equaliser	MOSFET 50 W x 4 Power	Time Alignment	I/R Remote Control compatible	Audio compatibility	SD	Direct Control for iPod/iPhone®
 SPH-10BT	✗	✓	✓	✓	✗	1	2	✗	✓	✓	13 Band (31 Band via PSS app)	✓	Manual	✗	MP3/WMA/WAV/AAC/FLAC	✗	iPhone® only
 MVH-S520BT	✗	✓	✗	✓	✗	1	3	✗	✓	✓	13 Band	✓	Manual	✗	MP3/WMA/WAV/AAC/FLAC	✗	iPhone® only
 MVH-S420BT	✗	✓	✗	✓	✗	1	2	✓	✓	✗	13 Band	✓	Manual	✗	MP3/WMA/WAV/AAC/FLAC	✗	iPhone® only
 MVH-S320BT	✗	Android only	✗	✓	✗	1	2	✓	✓	✗	13 Band	✓	Manual	✗	MP3/WMA/WAV/FLAC	✗	✗
 MVH-S120UB/UBA/UBB/UBG	✗	✗	✗	✗	✗	1	1	✓	✗	✗	5 Band	✓	✗	✗	MP3/WMA/WAV/FLAC	✗	✗
 FH-S720BT	✗	✓	✗	✓	✓	1	3	✗	✓	✓	13 Band / N	✓	Manual	✗	WMA/MP3/WAV/AAC/FLAC	✗	iPhone® only
 DEH-X9600BT	✗	✗	✗	✓	✓	2	3 (4V)	✗	✗	✓	5 Band	✓	✗	✓	MP3/WMA/WAV/AAC/FLAC	✓	✓
 DEH-X8700BT	✗	✗	✗	✓	✓	1	3 (4V)	✗	✗	✓	5 Band	✓	✗	✓	MP3/WMA/WAV/AAC/FLAC	✗	✓
 DEH-S520BT	✗	✓	✗	✓	✓	1	3	✗	✓	✓	13 Band	✓	Manual	✗	MP3/WMA/MAW/ACC/FLAC	✗	iPhone® only
 DEH-S420BT	✗	✓	✗	✓	✓	1	2	✗	✓	✗	13 Band	✓	✗	✗	MP3/WMA/MAW/ACC/FLAC	✗	iPhone® only
 DEH-S320BT	✗	Android only	✗	✓	✓	1	2	✗	✓	✗	13 Band	✓	✗	✗	MP3/WMA/WAV/FLAC	✗	✗
 DEH-S220UI	✗	✗	✗	✗	✓	1	2	✗	✓	✓	5 Band	✓	✗	✓	MP3/WMA/WAV	✗	✓
 DEH-S120UB/UBA/UBB/UBG	✗	✗	✗	✗	✓	1	1	✗	✗	✗	5 Band	✓	✗	✗	MP3/WMA/WAV/FLAC	✗	✗

Display Audio

Car Audio

Speakers

Subwoofers



















Amplifiers

Dash Camera

Product overview

Car Speakers

OVERVIEW WITH KEY SPECIFICATIONS

Z & D SERIES (PERI EXCLUSIVE)		Size	Type	Maximum power	Nominal Power	Frequency Response	Sensitivity	Impedance	Mounting Depth	Cut-out Dimensions	Recommended Enclosure (ft ³ / litre)
	 TS-Z65CH	17 cm	2-Way Comp. Speakers	330 W	110 W RMS	30 - 96 kHz	85 dB	4 Ω	65 mm	144 mm	×
	 TS-Z65C	17 cm	2-Way Comp. Speakers	300 W	100 W RMS	32 - 96 kHz	85 dB	4 Ω	65 mm	144 mm	×
	 TS-Z65F	17 cm	2-Way Speakers	330 W	110 W RMS	32 - 96 kHz	85 dB	4 Ω	65 mm	144 mm	×
	 TS-Z10LS4	25 cm	Shallow Mount Subwoofer	1300 W	400 W RMS	20 Hz - 3.8 kHz	76 dB	4 Ω	81 mm	231 mm	0.6 / 16.98
	 TS-Z10LS2	25 cm	Shallow Mount Subwoofer	1300 W	400 W RMS	20 Hz - 3.8 kHz	74 dB	2 Ω	81 mm	231 mm	0.6 / 16.98
	TS-D65F	17 cm	2-Way Speakers	270 W	90 W RMS	32 - 49 kHz	85 dB	4 Ω	65 mm	144 mm	×
	 TS-D65C	17 cm	2-Way Comp. Speakers	270 W	90 W RMS	32 - 49 kHz	84 dB	4 Ω	65 mm	144 mm	×
	TS-D69F	6" x 9"	2-Way Speakers	330 W	110 W RMS	33 - 42 kHz	87 dB	4 Ω	65 mm	153 x 222 mm	×
	TS-D12D4/D2	30 cm	Standard Subwoofer	2000 W	600 W RMS	20 Hz - 4.7 kHz	78 dB / 76 dB	Dual 4 Ω / Dual 2 Ω	157 mm	281 mm	1 / 28.3
	TS-D10D4/D2	25 cm	Standard Subwoofer	1500 W	500 W RMS	20 Hz - 6.6 kHz	76 dB / 74 dB	Dual 4 Ω / Dual 2 Ω	140 mm	230 mm	0.7 / 19.81
	TS-D10LB	25 cm	Enclosed Subwoofer	1300 W	350 W RMS	20 Hz - 6.6 kHz	74 dB	2 Ω	×	×	×
	TS-D10LS4/LS2*	25 cm	Shallow mount subwoofer	1300 W	350 W RMS	20 Hz - 3.4 kHz	76 dB / 74 dB	4 Ω / 2 Ω	84 mm	230 mm	0.6 / 17



HI-RES AUDIO captures every nuance from the original recording, hear the depth and breadth of each note, experiencing the subtleties of each instrument. You may never listen to ordinary compressed audio again.





















*Optional Speaker Grill UD-10GL available (sold separately)



For illustrative purposes only.

A SERIES

	Multi-fit Adaptor included	Size	Type	Maximum power	Nominal Power	Frequency Response	Sensitivity	Impedance	Mounting Depth	Cut-out Dimensions	Recommended Enclosure (ft ³ / litre)	Size (cm) (W x D x H)
	✓	16.5 cm	2-Way Comp. Speakers	350 W	80 W RMS	33 Hz - 58 kHz	90 dB	4 Ω	59 mm	144 mm	✗	✗
	✓	16.5 cm	3-Way Speakers	320 W	70 W RMS	37 Hz - 31 kHz	91 dB	4 Ω	48 mm	144 mm	✗	✗
	✗	13 cm	2-Way Comp. Speakers	300 W	50 W RMS	42 Hz - 58 kHz	89 dB	4 Ω	54 mm	121 mm	✗	✗
	✗	13 cm	3-Way Speakers	300 W	50 W RMS	44 Hz - 52 kHz	89 dB	4 Ω	54 mm	121 mm	✗	✗
	✗	6" x 9"	5-Way Speakers	700 W	120 W RMS	29 Hz - 33 kHz	92 dB	4 Ω	86 mm	153 x 222 mm	✗	✗
	✗	6" x 9"	4-Way Speakers	650 W	100 W RMS	22 Hz - 24 kHz	90 dB	4 Ω	86 mm	153 x 222 mm	✗	✗
	✓	6" x 9"	4-Way Speakers	600 W	100 W RMS	29 Hz - 33 kHz	92 dB	4 Ω	72 mm	153 x 222 mm	✗	✗
	✓	6" x 9"	3-Way Speakers	450 W	90 W RMS	29 Hz - 28 kHz	92 dB	4 Ω	72 mm	153 x 222 mm	✗	✗
	✗	6" x 8"	4-Way Speakers	350 W	80 W RMS	30 Hz - 32 kHz	90 dB	4 Ω	62 mm	133 x 194 mm	✗	✗
	✗	4" x 6"	4-Way Speakers	210 W	30 W RMS	34 Hz - 49 kHz	88 dB	4 Ω	42 mm	95 x 153 mm	✗	✗
	✗	10 cm	2-Way Speakers	230 W	50 W RMS	82 Hz - 40 kHz	90 dB	4 Ω	43 mm	106 mm	✗	✗
	✗	20 mm	Sound Upgrade Tweeter	450 W	100 W RMS	1.8 Hz - 58 kHz	90 dB	4 Ω	14 mm	38 mm	✗	✗
	✗	25 cm	3-Way Speakers	420 W	80 W	20 Hz - 31 kHz	92 dB	4 Ω	115 mm	236 mm	✗	✗
	✗	20 cm	3-Way Speakers	500 W	80 W	25 Hz - 28 kHz	91 dB	4 Ω	89 mm	186 mm	✗	✗
	✗	30 cm	Enclosed (passive) Subwoofer	1500 W	500 W RMS	20 Hz - 2.6 kHz	78 dB	2 Ω	147 mm	✗	✗	484 (W) x 374 (H) x 463 (D) mm
	✗	30 cm / 25 cm	Shallow Enclosed (passive) Subwoofer	1500 W / 1200 W	400 W RMS / 300 W RMS	20 Hz - 1.0 kHz / 20 - 900 Hz	88 dB / 86 dB	2 Ω	✗	✗	✗	350 (W) x 170 (H) x 600 (D) mm / 605 (W) x 387 (H) x 204 (D) mm
	✗	20 cm	Shallow Enclosed (passive) Subwoofer	700 W	250 W RMS	25 - 1.4 kHz	84 dB	2 Ω	✗	✗	✗	350 (W) x 130 (H) x 250 (D) mm
	✗	30 cm	Standard Subwoofer	1400 W	400 W RMS	22 Hz - 1.6 kHz	87 dB	4 Ω	136 mm	281 mm	1.25 / 35.4	✗
	✗	30 cm	Standard Subwoofer	1500 W	500 W RMS	20 Hz - 2.3 kHz	77 dB	Dual 4 Ω / 4 Ω	147 mm	281 mm	1.25 / 35.4	✗
	✗	25 cm	Standard Subwoofer	1300 W	400 W RMS	20 Hz - 2 kHz	74 dB / 73 dB	Dual 4 Ω / 4 Ω	133 mm	230 mm	0.7 / 19.8	✗
	✗	30 cm / 25 cm	Shallow Subwoofer	1500 W / 1200 W	400 W / 300 W RMS	20 - 1.0kHz / 20 - 900 Hz	88 dB / 85 dB	4 Ω / 4 Ω	90 mm / 87 mm	281 mm / 230 mm	0.8 / 22.6 / 0.6 / 17	✗
	✗	20 cm	Shallow Subwoofer	700 W	250 W RMS	20 - 1.4 kHz	83 dB	Dual 2 Ω	67 mm	179 mm	0.5 / 14.2	✗













Scan the QR Code to discover more!



Car Speakers

OVERVIEW WITH KEY SPECIFICATIONS







G & R SERIES		Size	Type	Maximum power	Nominal Power	Frequency Response	Sensitivity	Impedance	Mounting Depth	Cut-out Dimensions
	TS-G170C	17 cm	2-Way Comp. Speakers	300 W	45 W	36 Hz - 26 kHz	91 dB	4 Ω	50 mm	144 mm
	TS-G1730F / TS-G1720F	17 cm	3-Way / 2-Way Speakers	300 W	40 W	36 Hz - 18 kHz	90 dB	4 Ω	50 mm	144 mm
	TS-G1710F	17 cm	Dual Cone Speakers	280 W	40 W	34 Hz - 16 kHz	89 dB	4 Ω	50 mm	144 mm
	TS-G130C	13 cm	2-Way Comp. Speakers	250 W	40 W	37 Hz - 27 kHz	88 dB	4 Ω	44 mm	121 mm
	TS-G1330F / TS-G1320F	13 cm	3-Way / 2-Way Speakers	250 W	35 W	33 Hz - 24 kHz	88 dB	4 Ω	44 mm	121 mm
	TS-G1310F	13 cm	Dual Cone Speakers	230 W	35 W	25 Hz - 22 kHz	89 dB	4 Ω	44 mm	121 mm
	TS-G1030F / TS-G1020F	10 cm	3-Way / 2-Way Speakers	210 W	30 W	35 Hz - 27 kHz	87 dB	4 Ω	43 mm	106 mm
	TS-G1010F	10 cm	Dual Cone Speakers	190 W	30 W	44 Hz - 25 kHz	89 dB	4 Ω	43 mm	106 mm
	TS-G6930F	6" x 9"	3-Way Speakers	400 W	45 W	32 Hz - 32 kHz	90 dB	4 Ω	70 mm	151 x 222 mm
	TS-R1750S	17 cm	3-Way Speakers	250 W	40 W	36 Hz - 31 kHz	90 dB	4 Ω	47 mm	137 mm
	TS-R1350S	13 cm	3-Way Speakers	250 W	35 W	44 Hz - 31 kHz	89 dB	4 Ω	47 mm	121 mm
	TS-R6951S	6" x 9"	3-Way Speakers	400 W	50 W	31 Hz - 35 kHz	92 dB	4 Ω	68 mm	153 x 222 mm



Dash Camera

OVERVIEW WITH KEY SPECIFICATIONS

	Camera Type	Screen Size	Resolution	Voice Guidance/ Voice Recognition	Security Mode	Night Time Mode	Viewing Angle	Rear Camera	Advanced Driver Assistance Systems (ADAS)	Mirror Type	Ultra Compact Size	Sensor
	VREC-Z810SH	Front 3" LCD	4K (3840 x 2160 p) 2K (2848 x 1600 p) Full HD (1920 x 1080 p)	✓	24/7 ⁽¹⁾	✓	139°	Optional ⁽³⁾	Stop & Go FCWS ⁽⁴⁾ LDWS ⁽⁵⁾	✗	✗	Sony's CMOS sensor with STARVIS™ technology
	VREC-Z710SH	Front 2" LCD	Full HD (1920 x 1080 p)	✗	24/7 ⁽¹⁾	✓	160°	Optional ⁽³⁾	Tailgating Warning	✗	✗	Sony's CMOS sensor with STARVIS™ technology
	VREC-H310SH	Front 3" LCD	Full HD (1920 x 1080 p)	✗	24/7 ⁽¹⁾	✓	139°	Optional ⁽³⁾	FCWS ⁽⁴⁾ LDWS ⁽⁵⁾	✗	✗	Sony's CMOS sensor with STARVIS™ technology
 <small>VREC-150MD is not available in all countries.</small>	VREC-150MD	Front & Rear 6.7" LCD Touchscreen	Front: Full HD (1920 x 1080 p) Rear: HD (1280 x 720 p)	✗	✗	✗	Front: Horizontal 118°, Vertical 60°, Diagonal 150° Rear: Horizontal 105°, Vertical 60°, Diagonal 120°	Included	✗	✓	✗	CMOS sensor
	VREC-DH200	Front ✗	Full HD (1920 x 1080 p)	✗	✗	✗	130°	✗	✗	✗	✓	CMOS sensor
	VREC-170RS	Front 3" LCD	Full HD (1920 x 1080 p)	✗	✓ ⁽²⁾	✗	139°	✗	FCWS ⁽⁴⁾ LDWS ⁽⁵⁾	✗	✗	CMOS sensor
	VREC-130RS	Front 2" LCD	Full HD (1920 x 1080 p)	✗	✗	✗	132°	✗	✗	✗	✗	CMOS sensor

(1) Hard Wire kit included in the box.
 (2) Utilising the internal built-in battery, when Dash Camera detects movement caused by vibration, it will automatically start to record an event for a fixed period of time.
 (3) Optional rear camera ND-RC1 sold separately.
 (4) Front Collision Warning System (FCWS).
 (5) Lane Departure Warning System (LDWS).



Scan the QR Code to discover more!



FIT MY CAR

FIND PRODUCTS THAT FIT YOUR CAR

Want to replace or upgrade your receiver or speaker system? Check our 'Fit My Car' tool, fill in your car brand, model, year and you will receive an overview of all compatible Pioneer products and accessories required to fit your vehicle.

Scan the QR Code to discover more!

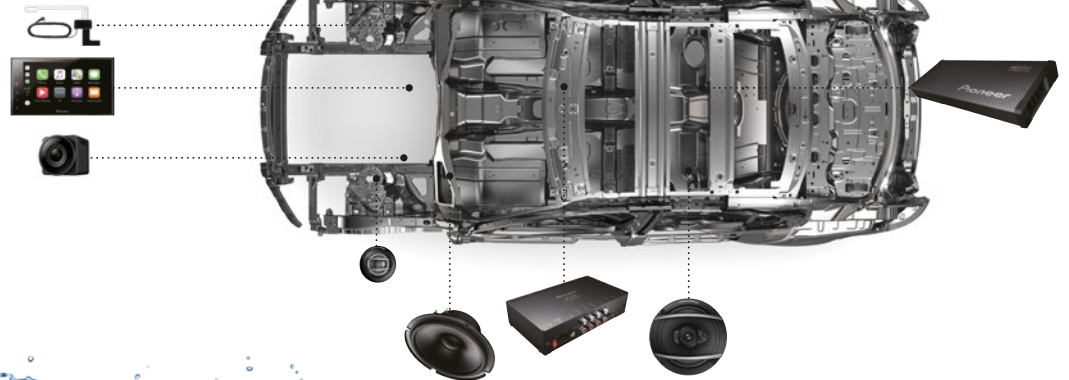

Car brand	- Select -
Car model	▼
Year	▼
Category	▼



PIONEER MARINE SERIES

Designed for Marine use, Pioneer's Marine series resist moisture, fading and stains, offering enhanced environmental protection from the effects of the sun and typical weather conditions that regular products are not designed to sustain.

Scan the QR Code to discover more!



Pioneer
PIONEER EUROPE N.V.

Haven 1087
Keetberglaan 1
B-9120 Melsele
Belgium
Tel.: +32 (0)3 570 05 11

WHERE TO BUY.

Scan the QR code for a Pioneer dealer close to you:



Apple, iPod, iPhone®, iTunes, CarPlay and the CarPlay logo are registered trademarks of Apple Inc., registered in the U.S. and other countries. "Made for iPod/iPhone®" means that an electronic accessory has been designed to connect specifically to iPod/iPhone® and has been certified by the developer to meet Apple performance standards. Apple is not responsible for the operation of this device or its compliance with safety or regulatory standards. Pioneer does not sell iPod or iPhone® devices. "Works with Apple CarPlay®" means that an electronic accessory has been designed to connect specifically to iPhone® and has been certified by the developer to meet Apple performance standards. Apple CarPlay® may not be available in some regions. For the latest information on availability, please check <http://www.apple.com/ios/carplay/>. Apple CarPlay® is available on Apple iPhone® 5 or later with iOS 7.1 or higher, and requires Lightning to USB cable. Android, Android Auto™, Google Maps, Waze and Talk to Google are registered trademarks of Google Inc. Android Auto™ is available with Android phone running Android 5.0(Lollipop) or higher with a data plan. Availability of Android Auto™ may vary depending upon your country and phone model. Please visit <http://www.android.com/auto> for more information. The Bluetooth® word mark and logos are registered trademarks owned by the Bluetooth SIG, Inc. and any use of such marks by PIONEER CORPORATION is under license. SD and SDHC are trademarks or registered trademarks of SD-3C, LLC in the United States, other countries or both. The "DVD" logo is a trademark of DVD Format/Logo Licensing Corporation. DAB is a registered trademark owned by one of the Eureka Project 147 partners. HERE is a registered trademark and HERE MAPS and the HERE MAPS LOGO are trademarks of HERE North America, LLC. Spotify is the registered trademark of the Spotify Group. Twaron® is a registered trademark of Teijin Aramid BV. WebLink® is a trademark of Abalta Technologies, Inc. Facebook is a trademark of Facebook, Inc. Twitter is a registered trademark of Twitter, Inc. YouTube is a trademark of Google Inc. The Instagram name and logo are trademarks of Instagram. Amazon, Alexa and all related marks are trademarks of Amazon.com, Inc. or its affiliates. STARVIS is a trademark of Sony Corporation. Other trademarks and trade

names are those of their respective owners. Pioneer and the Pioneer logo are registered trademarks of Pioneer Corporation. Features and specifications of the products described or illustrated in this brochure are correct at the time of printing but could change as production changes might occur. This brochure may contain typographical errors and the colours of the depicted products may deviate slightly from reality. Consult your Pioneer dealer to ensure that actual features and specifications match your requirements. This brochure may contain references to products that may or will not be available in your country. Pioneer has a team of expert professionals across Europe who have the knowledge, experience and passion to be able to sell and install the Pioneer's Z and D series. For details of where you can find these Pioneer partners, please visit www.pioneer-car.eu. The EU Directive establishing the European Electric Communications Code ('EECC') on the Digital Audio Broadcasting ('DAB') is to be implemented by all EU member states by 20 December 2020, so that the concerned legislation may vary per country and is subject to change. Therefore, we recommend to consult the status of the national legislation of your country before purchasing a non-DAB car radio receiver. The DAB/DAB+ Digital Radio products listed are Digital Radio Tick Mark Approved products. This means Pioneer has met the minimum Digital Radio specification, verified by independent testing. All Pioneer products that use this Digital Radio Tick Mark have been independently tested and approved so you can buy with confidence.

For an overview of our European offices, distributors and support, please check: www.pioneer-car.eu/contact-us. For detailed information concerning Pioneer's environmental policy, please visit: pioneer-car.eu/about-pioneer/environment.

WWW.PIONEER-CAR.EU

FACEBOOK.COM/PIONEERCAR
X.COM/PIONEEREUROPE

PIONEER EUROPE
PIONEER_CAR_UK